

## **Distribution Agreement**

In presenting this thesis or dissertation as a partial fulfillment of the requirements for an advanced degree from Emory University, I hereby grant to Emory University and its agents the non-exclusive license to archive, make accessible, and display my thesis or dissertation in whole or in part in all forms of media, now or hereafter known, including display on the world wide web. I understand that I may select some access restrictions as part of the online submission of this thesis or dissertation. I retain all ownership rights to the copyright of the thesis or dissertation. I also retain the right to use in future works (such as articles or books) all or part of this thesis or dissertation.

Signature:

---

Myra E. Woodworth-Hobbs

---

Date

Docosahexaenoic Acid Prevents the Activation of Proteolytic Signaling by Palmitate in  
Skeletal Muscle Cells: Implications for Lipid-Induced Muscle Atrophy

By

Myra Woodworth-Hobbs  
Doctor of Philosophy

Graduate Division of Biological and Biomedical Sciences  
Nutrition and Health Sciences

---

S. Russ Price, Ph.D.  
Advisor

---

James Bailey, M.D.  
Committee Member

---

Lou Ann Brown, Ph.D.  
Committee Member

---

Thomas Burkholder, Ph.D.  
Committee Member

---

Ngoc-Anh Le, Ph.D.  
Committee Member

Accepted:

---

Lisa A. Tedesco, Ph.D.  
Dean of the James T. Laney School of Graduate Studies

---

Date

Docosahexaenoic Acid Prevents the Activation of Proteolytic Signaling by Palmitate in  
Skeletal Muscle Cells: Implications for Lipid-Induced Muscle Atrophy

By

Myra E. Woodworth-Hobbs

B.S., West Virginia University, 2006

M.S., West Virginia University, 2009

Advisor: S. Russ Price, Ph.D.

An abstract of  
A dissertation submitted to the Faculty of the  
James T. Laney Graduate Studies of Emory University  
in partial fulfillment of the requirements for the degree of  
Doctor of Philosophy  
in Graduate Division of Biological and Biomedical Sciences  
Nutrition and Health Sciences  
2014

## Abstract

### Docosahexaenoic Acid Prevents the Activation of Proteolytic Signaling by Palmitate in Skeletal Muscle Cells: Implications for Lipid-Induced Muscle Atrophy

By Myra E. Woodworth-Hobbs

Skeletal muscle atrophy is a comorbidity common to numerous chronic illnesses and is an independent prognostic indicator of mortality in these patients. Some of these illnesses are characterized by dyslipidemia and the ectopic accumulation of lipids in skeletal muscle. Accumulation of saturated lipids such as palmitate in skeletal muscle causes derangements in insulin-related signaling and other cellular insults such as endoplasmic reticulum (ER) stress which augment the activities of multiple proteolytic systems. The latter responses result in wasting or atrophy. Notably, high doses of fish oil and combinations of omega-3 polyunsaturated fatty acids (PUFAs) have been found to help cancer patients maintain lean body mass. In other studies, PUFAs, including docosahexaenoic acid (DHA), have been shown to positively regulate some signaling pathways that control protein homeostasis in skeletal muscle. These findings led us to hypothesize that DHA counteracts palmitate-induced atrophy of cultured muscle cells by preventing the dysregulation of various proteolytic systems and their upstream signaling pathways. This dissertation focuses on elucidating the mechanism(s) by which DHA positively impacts muscle protein metabolism by examining the effects of palmitate and DHA on Akt- and ER stress-related signaling pathways in an *in vitro* model system.

The protein kinase Akt is a key modulator of protein balance that inhibits the forkhead box O (FoxO) transcription factors which selectively induce the transcription of atrophy-inducing genes in the ubiquitin-proteasome and autophagy-lysosome systems. ER stress induces the unfolded protein response which causes perturbations in protein turnover and mitochondrial instability, leading to activation of autophagy and caspase-mediated proteolysis. Our work demonstrates that DHA prevents the suppression of Akt activity and induction of ER stress induced by palmitate, thus limiting the up-regulation of the ubiquitin-proteasome, autophagy-lysosome, and caspase-mediated proteolytic systems caused by the saturated fatty acid. The experiments presented in this dissertation are the first to directly examine the effects of DHA on protein catabolism in cultured muscle cells. The results establish a rationale for further research into the use of DHA as a treatment to counteract the loss of muscle mass due to catabolic illnesses.

Docosahexaenoic Acid Prevents the Activation of Proteolytic Signaling by Palmitate in  
Skeletal Muscle Cells: Implications for Lipid-Induced Muscle Atrophy

By

Myra E. Woodworth-Hobbs

B.S., West Virginia University, 2006

M.S., West Virginia University, 2009

Advisor: S. Russ Price, Ph.D.

A dissertation submitted to the Faculty of the  
James T. Laney Graduate Studies of Emory University  
in partial fulfillment of the requirements for the degree of  
Doctor of Philosophy  
in Graduate Division of Biological and Biomedical Sciences  
Nutrition and Health Sciences  
2014

## **Acknowledgements**

The people who have helped me on my journey to earning a doctoral degree are innumerable; there is simply not enough space or time to acknowledge them all by name. I am thankful for the educators and mentors who have inspired me to pursue this path and encouraged me along the way, as well as modeled for me how to engage and inspire others. I am also grateful to have supportive family, friends, and colleagues who continually offer kind words of encouragement and invaluable advice and always know how to make me laugh and appreciate the good things in life.

I offer deep gratitude to my mentors Drs. Russ Price and Randy Bryner for providing me with the opportunity to pursue my interests, giving me their time and support, and generously sharing with me their experiences and wisdom. I also want to thank the faculty members who served on my master's thesis and doctoral dissertation committees for sharing with me their time and expertise: Drs. Stephen Alway, David Williamson, Thomas Burkholder, Lou Ann Brown, James Bailey, and Ngoc-Anh Le. Thank you for guiding me through graduate school and pushing me to succeed. Your influence has made me a better scientist, teacher, and person.

I am unable to adequately articulate the blessing that is my family. To my husband and best friend Ryan: you were willing to leave your beloved West Virginia mountains to move to Atlanta, and I thank you for your sacrifice to be by my side. I could not have made it through graduate school without your steadfast support and faith in me, and equally as importantly, our shared laughter. Thank you for helping me appreciate and enjoy what is truly important in life. To my parents Clarence and Cindy, my sister Leah, my in-laws Patty, Buggy, Tricia, and Julie, my Aunt Carol and Auntie Joyce, and the

many other Woodworth and Hobbs family members: thank you for lending an ear when I need to talk, picking me up when I am down, offering sage advice when I am confused, and patiently delivering a reality check when I need a swift kick in the rear. You have unwaveringly supported me through this journey and I am extraordinarily grateful for you.

## TABLE OF CONTENTS

<b>CHAPTER 1</b> .....	<b>1</b>
<b>INTRODUCTION</b> .....	<b>1</b>
<b>CHAPTER 2</b> .....	<b>5</b>
<b>BACKGROUND AND SIGNIFICANCE</b> .....	<b>5</b>
<b>SKELETAL MUSCLE ATROPHY</b> .....	<b>6</b>
<i>Overview of skeletal muscle</i> .....	6
<i>Insulin resistance and type 2 diabetes mellitus</i> .....	9
<i>Muscle atrophy and diabetes</i> .....	10
<b>PROTEOLYTIC SYSTEMS IN SKELETAL MUSCLE</b> .....	<b>13</b>
<i>Ubiquitin-proteasome system</i> .....	14
<i>Caspase-mediated proteolysis</i> .....	20
<i>Autophagy-lysosome system</i> .....	21
<i>Calpains</i> .....	27
<i>Regulation of proteolysis in skeletal muscle</i> .....	27
<b>ENDOPLASMIC RETICULUM STRESS AND THE UNFOLDED PROTEIN RESPONSE</b> .....	<b>30</b>
<i>The ATF6 pathway</i> .....	32
<i>The IRE1<math>\alpha</math>-XBP1 pathway</i> .....	34
<i>The PERK-eIF2<math>\alpha</math>-ATF4 pathway</i> .....	34
<i>The PERK-Nrf2 pathway</i> .....	36
<i>ER associated degradation</i> .....	37
<i>CHOP mediates ER stress-induced cell death</i> .....	38
<i>Endoplasmic reticulum stress and UPR is activated in disease</i> .....	41
<b>FATTY ACIDS</b> .....	<b>42</b>
<i>Fatty acid structure and nomenclature</i> .....	42
<i>Synthesis of saturated and omega-3 polyunsaturated fatty acids</i> .....	44
<i>Efficiency of omega-3 conversion in humans</i> .....	47
<i>Dietary consumption of saturated and omega-3 fatty acids</i> .....	48
<i>Relationship of palmitate and omega-3 fatty acids and cardiovascular health</i> .....	50
<i>Potential cellular mechanisms underlying the differential effects of saturated and unsaturated fatty acids</i> .....	51
<b>LIPIDS AND SKELETAL MUSCLE</b> .....	<b>54</b>



<i>Dietary lipids affect skeletal muscle lipids</i> .....	54
<i>Lipids and skeletal muscle insulin resistance</i> .....	55
<i>Lipids and ER stress</i> .....	59
<i>Lipids and muscle atrophy</i> .....	63
<b>SUMMARY AND SIGNIFICANCE</b> .....	<b>70</b>
<b>CHAPTER 3</b> .....	<b>73</b>
<b>DOCOSAHEXAENOIC ACID PREVENTS PALMITATE-INDUCED ACTIVATION OF PROTEOLYTIC SYSTEMS IN C2C12 MYOTUBES</b> .....	<b>73</b>
<b>INTRODUCTION</b> .....	<b>74</b>
<b>METHODS AND MATERIALS</b> .....	<b>76</b>
<i>Cultured myotube model</i> .....	76
<i>Experimental treatments</i> .....	77
<i>Protein degradation assay</i> .....	77
<i>RNA isolation and qPCR analysis</i> .....	78
<i>Isolation of cytosolic and nuclear cell fractions</i> .....	78
<i>Western blot analysis</i> .....	79
<i>Statistical analyses</i> .....	80
<b>RESULTS</b> .....	<b>80</b>
<i>DHA attenuates the effects of palmitate on protein degradation</i> .....	80
<i>DHA attenuates palmitate-induced inhibition of Akt-FoxO3 signaling</i> .....	80
<i>DHA attenuates the effects of palmitate on proteolytic systems</i> .....	84
<b>DISCUSSION</b> .....	<b>87</b>
<b>ACKNOWLEDGEMENTS</b> .....	<b>94</b>
<b>CHAPTER 4</b> .....	<b>95</b>
<b>DOCOSAHEXAENOIC ACID COUNTERACTS PALMITATE-INDUCED ER STRESS IN C2C12 MYOTUBES: INSIGHTS INTO FATTY ACID-INDUCED MUSCLE ATROPHY</b> .....	<b>95</b>
<b>BACKGROUND</b> .....	<b>96</b>
<b>METHODS AND MATERIALS</b> .....	<b>98</b>
<i>Cultured myotube model</i> .....	98
<i>Experimental treatments</i> .....	99
<i>RNA isolation and qPCR analysis</i> .....	99
<i>Western blot analysis</i> .....	99

<i>Statistical analyses</i> .....	100
<b>RESULTS</b> .....	<b>100</b>
<i>DHA attenuates the induction of ER stress by palmitate</i> .....	100
<i>DHA prevents palmitate-induced activation of ER stress-associated proteolytic pathways</i> .....	102
<b>DISCUSSION</b> .....	<b>108</b>
<b>CHAPTER 5</b> .....	<b>115</b>
<b>DISCUSSION AND CONCLUSIONS</b> .....	<b>115</b>
<b>FATTY ACIDS AFFECT MUSCLE PROTEIN BALANCE</b> .....	<b>116</b>
<b>AKT/FOXO SIGNALING AND ER STRESS COLLABORATIVELY REGULATE PROTEOLYSIS IN MYOTUBES</b> .....	<b>117</b>
<b>FUTURE DIRECTIONS</b> .....	<b>120</b>
<i>The potential role of protein synthesis in palmitate-induced myotube atrophy</i> .....	120
<i>The potential role of oxidative stress in myotube atrophy: differential effects of palmitate and DHA</i> .....	121
<i>DHA may prevent disruption of ER calcium homeostasis</i> .....	123
<i>Palmitate and DHA may differentially alter microRNA expression</i> .....	124
<b>CONCLUSIONS</b> .....	<b>125</b>
<b>REFERENCES</b> .....	<b>127</b>

## FIGURES

2.1. Sarcomeric proteins and structure.....	7
2.2. The ubiquitin proteasome system.....	15
2.3. Caspase-mediated proteolysis.....	22
2.4. The autophagy-lysosome system.....	26
2.5. Endoplasmic reticulum stress and the unfolded protein response.....	33
2.6. Interconversion of omega-6 and omega-3 PUFAs.....	46
3.1. Docosahexaenoic acid prevents palmitate-induced protein degradation.....	81
3.2. DHA prevents palmitate-induced suppression of Akt activation.....	82
3.3. Co-treatment with DHA prevents palmitate-induced alterations in FoxO3 localization.....	85
3.4. Co-treatment with DHA prevents the PA-induced increase in atrogin-1 mRNA levels.....	86
3.5. Co-treatment with DHA prevents the PA-induced increase in macroautophagy.....	88
3.6. The Akt/FoxO3 axis is a key regulator of the activity of various proteolytic pathways in muscle cells.....	90
4.1. Co-treatment with DHA attenuates the palmitate (PA)-induced increase in PERK activation.....	101
4.2. Co-treatment with DHA does not reduce PA-induced phosphorylation of eIF2 $\alpha$ .....	103
4.3. Co-treatment with DHA antagonizes the palmitate-induced increase in ATF4/CHOP signaling.....	105
4.4. DHA prevents palmitate-induced activation of other UPR arms.....	106
4.5. Co-treatment with DHA prevents ER stress-related caspase-3 activation induced by palmitate.....	107
4.6. ER stress enhances autophagy-related signaling in myotubes.....	109
4.7. ER stress pathways participate in the regulation of muscle protein homeostasis by palmitate and DHA.....	110
5.1. DHA limits the induction of multiple proteolytic pathways by palmitate.....	118

## **TABLES**

2.1. Physiological and pathophysiological conditions associated with muscle atrophy. ....	11
2.2 Fatty acid nomenclature .....	45

## LIST OF ABBREVIATIONS

$\omega$ -3	omega-3
$\omega$ -6	omega-6
AA	arachadonic acid
ALA	$\alpha$ -linolenic acid
ATF	activating transcription factor
Atg	autophagy-related
Bnip3	Bcl2 and adenovirus E1B 19-kDa-interacting protein 3
ca-	constitutively active
CHD	coronary heart disease
CHOP	C/EBP homologous protein
CKD	chronic kidney disease
Dex	dexamethasone
DHA	docosahexaenoic acid
dn-	dominant negative
eIF2 $\alpha$	eukaryotic initiation factor 2 alpha
EPA	eicosapentaenoic acid
ER	endoplasmic reticulum
ERAD	endoplasmic reticulum associated degradation
FAs	fatty acids
FoxO	forkhead box O
IGF1	insulin-like growth factor 1

IOM.....Institute of Medicine  
ISGU.....insulin-simulated glucose uptake  
IRE1 $\alpha$ .....inositol-requiring element 1 alpha  
IRS1.....insulin receptor substrate 1  
LA.....linoleic acid  
LC3.....microtubule-associated protein light chain 3  
MAFbx.....muscle atrophy F box  
MAMs.....mitochondria-associated ER membranes  
MUFAs.....monounsaturated fatty acids  
MuRF1.....muscle RING finger protein 1  
NEFA.....non-esterified fatty acids  
NHANES.....National Health and Nutrition Examination Survey  
Nrf2.....nuclear factor erythroid 2-related factor  
OA.....oleic acid  
PA.....palmitic acid  
PERK.....protein kinase R-like ER protein kinase  
PI3K.....phosphatidylinositol 3-kinase  
PUFAs.....polyunsaturated fatty acids  
SERCA.....SR/ER calcium-ATPase  
SFAs.....saturated fatty acids  
SR.....sarcoplasmic reticulum  
T2DM.....type 2 diabetes mellitus  
UbP.....ubiquitin-proteasome

Ub.....ubiquitin  
UFAs.....unsaturated fatty acids  
UPR.....unfolded protein response  
Xbp1.....X-box binding protein 1

**CHAPTER 1**  
**INTRODUCTION**



Skeletal muscle atrophy is a frequent consequence of many common pathologic conditions, including type 2 diabetes mellitus (T2DM). The loss of muscle mass reduces quality of life and is an independent predictor of mortality in these patients [1, 2]. Muscle mass is controlled by a balance between protein synthesis and degradation pathways. Derangements in insulin signaling and other cellular insults such as endoplasmic reticulum (ER) stress are frequent aspects of the pathophysiology of many chronic metabolic diseases and contribute to the dysregulation of protein homeostasis in skeletal muscle. Defects in skeletal muscle insulin signaling are largely responsible for the development of systemic insulin resistance and, ultimately, T2DM [3]. ER stress in liver, pancreas, and adipose tissue also contributes to the pathogenesis of T2DM and other chronic diseases [4-7]; however, the relationship between ER stress and metabolic derangement in skeletal muscle has not been well-studied [8]. Given the important role of skeletal muscle in the regulation of whole body metabolism, the dysregulation of these pathways and the resultant loss in muscle protein is a particularly detrimental comorbidity for T2DM and other conditions characterized by systemic metabolic dysfunction.

Obesity is a predisposing factor for T2DM and many of the other chronic illnesses associated with muscle atrophy [9]. Unquestionably, nutrition is an integral part of the pathogenesis, and in some cases treatment, of these conditions. Many of these patients suffer from dyslipidemia, including elevated total levels of circulating non-esterified fatty acids [10] with a decreased abundance of circulating and tissue omega-3 polyunsaturated fatty acids [11-13]. Prevailing evidence suggests that diets high in saturated fatty acids are detrimental to cardiovascular and metabolic health while incorporation of dietary

omega-3 polyunsaturated fatty acids exerts beneficial effects on health outcomes [14-21]. The composition of membrane and intracellular lipids in skeletal muscle reflect the composition of dietary lipids [22-25]; therefore, dietary lipids can directly influence skeletal muscle metabolism. Numerous *in vitro* and *in vivo* studies have begun to elucidate how saturated and omega-3 polyunsaturated fatty acids alter specific molecular signaling pathways that regulate metabolic processes [20, 21, 26-33]. High levels of saturated fatty acids, such as palmitate, have been shown to suppress insulin signaling and induce ER stress in skeletal muscle [34-36]. There is evidence that omega-3 fatty acids improve insulin signaling in muscle [20, 21, 37], but the effects of omega-3 fatty acids on ER stress in muscle have not been studied.

The majority of studies examining the effects of omega-3 fatty acids on pathways regulating protein metabolism in muscle have used fish oil [25, 37-39], which contains both eicosapentaenoic acid (EPA) and docosahexaenoic acid (DHA). Individuals are more likely to have a suboptimal levels of DHA than EPA because EPA is readily synthesized from the abundant fatty acid precursor alpha-linolenic acid [18, 40-42], while increasing DHA in the blood and tissues requires consumption of pre-formed DHA [41-44]. DHA is the most highly enriched polyunsaturated fatty acid in skeletal muscle ER and mitochondrial membranes [44]; therefore, DHA supplementation may improve the ability of these organelles to function when cellular stresses are present. In this regard, previous work has established that DHA counteracts the decrease in diameter of cultured myotubes in response to high levels of palmitate [33], suggesting that this omega-3 fatty acid may prevent the dysregulation of signaling pathways that control protein homeostasis in muscle. Elucidation of the mechanisms by which DHA positively impacts

muscle protein metabolism may facilitate development of effective nutritional therapies for muscle atrophy.

Since catabolic illness-induced muscle atrophy typically results from a sustained increase in the rate of protein degradation [45], the overarching goal of this body of research was to examine whether DHA antagonizes the atrophy-inducing effects of palmitate by examining various proteolytic systems and their upstream signaling pathways. Cultured C2C12 myotubes were used as a model system to study the specific effects of these fatty acids in muscle cells. They provide a simpler model that allow investigators to focus on the direct effects of DHA rather than potential confounding indirect effects that are present in more complex *in vivo* models. We hypothesized that DHA would counteract palmitate-induced myotube atrophy by restoring Akt signaling and reducing ER stress, thus preventing the activation of multiple proteolytic systems including the ubiquitin-proteasome, autophagy-lysosome, and caspase-mediated pathways. The experiments presented in this dissertation are the first to directly examine the effects of DHA on protein catabolism in cultured muscle cells. The results demonstrate that DHA prevents palmitate-induced myotube atrophy by multiple mechanisms and establish a rationale for further research into the use of DHA as a treatment to counteract the loss of muscle mass due to catabolic illnesses.

**CHAPTER 2**  
**BACKGROUND AND SIGNIFICANCE**

## **SKELETAL MUSCLE ATROPHY**

### *Overview of skeletal muscle*

Skeletal muscle plays an important role in the activities of daily living and is essential for health and survival. Comprising approximately 40% of total body mass, it is the largest organ in healthy humans. There are over 600 skeletal muscles in the human body, and each is comprised of hundreds to hundreds of thousands of multinucleated, elongated cells called fibers. In turn, fibers are comprised of a variable number of myofibrils [46]. Myofibrillar proteins are responsible for the contractile properties of muscle and comprise the greatest portion (~55-60%) of total skeletal muscle protein [47].

The two primary myofibrillar proteins, myosin and actin, are incorporated into the thick and thin filaments, respectively, along with at least 15 other proteins that are part of the myofibrillar structure. These filaments are arranged in longitudinally repeating units called sarcomeres, which are defined on the edges by Z-disks. Thin filaments directly attach to the Z-disks, and thick filaments are indirectly attached to the Z-disks through binding to the protein titin. Thick filaments also attach in the center of the sarcomere at the M-line. When viewed under a microscope, the area containing the thick filaments (the A band) appears darker than the area containing only thin filaments and Z-disks (I band); therefore, the banded structure of the sarcomere gives skeletal muscle its striated appearance [46]. **Figure 2.1** shows a simplified schematic of the sarcomeric proteins and structure.

The two other classes of muscle proteins include the sarcoplasmic and the stroma proteins, which comprise ~30-35% and ~10-15% of total muscle protein, respectively.

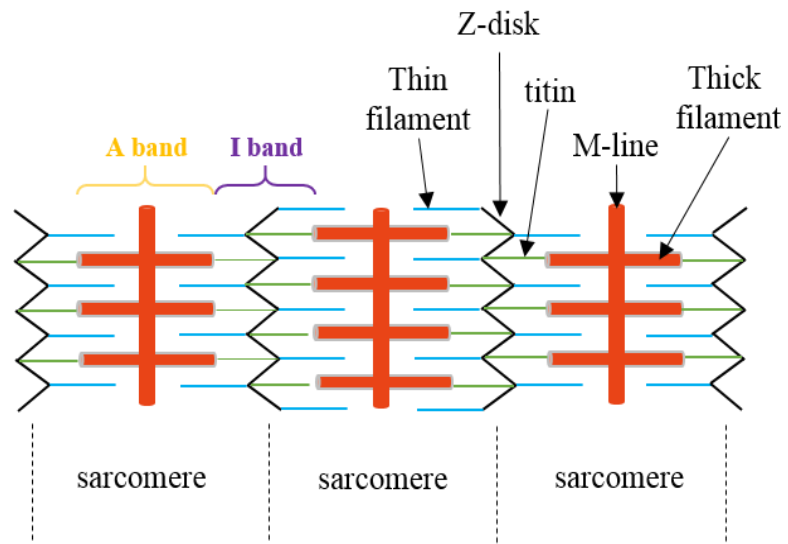

*Figure 2.1. Sarcomeric proteins and structure.*

The class of sarcoplasmic proteins is comprised of hundreds of intracellular polypeptides that function in numerous processes, such as enzymes and cofactors involved in the metabolism of nutrients. Stroma proteins, such as extracellular matrix proteins and collagen, are mostly extracellular and function in cell-cell contact, structural integrity, and transmission of force [47].

The daily turnover of muscle protein is highly dynamic and is controlled by a delicate balance between protein synthesis and protein degradation pathways. Healthy adults turnover about 1.5 kg of muscle tissue per day, thus even small changes in protein synthesis or protein degradation can significantly impact total muscle mass [48]. Skeletal muscle exhibits considerable plasticity, meaning that it changes and adapts in response to external stimuli, such as mechanical load, hormones, nutrients, and other systemic or cell signals. This plasticity is apparent at the level of the myofiber. Alterations in protein balance do not typically change the number of myofibers but instead cause an increase or decrease in the size (i.e. cross-sectional area) of individual myofibers, which is ultimately reflected as an increase (hypertrophy) or decrease (atrophy) in whole muscle volume and mass [46, 49].

Skeletal muscle is important for numerous physiological functions. It provides the mechanical power for basic processes such as respiration, vision, and mastication. Beyond basic locomotion involved in activities of daily living, an individual's physical strength, endurance, and performance are also highly-dependent on muscle mass. Skeletal muscle also plays a fundamental role in whole-body metabolism. It is the primary reservoir of amino acids that can be mobilized into the blood to be used for synthesis of proteins by other tissues or as a hepatic gluconeogenic substrate for maintenance of blood

glucose during the fasting state [2]. The capacity for net protein breakdown to maintain blood amino acids is extraordinary. For example, obese individuals (with increased muscle mass) were able to maintain normal plasma amino acid concentrations after more than 60 days of starvation [50]. Conversely, depletion of muscle mass is incompatible with life; death in human starvation occurs because depletion of muscle mass restricts the availability of adequate gluconeogenic precursors [2]. Skeletal muscle is also a primary target of the peptide hormone insulin. Insulin stimulates glucose transport and glycogen storage in skeletal muscle, and this tissue is responsible for the majority of postprandial glucose uptake. Insulin also stimulates protein synthesis and inhibits protein degradation pathways in muscle.

#### *Insulin resistance and type 2 diabetes mellitus*

The abnormal response of skeletal muscle and other target tissues to normal or high levels in insulin, termed insulin resistance, is an early predisposing factor in the pathogenesis of T2DM. Two of the primary actions of insulin are to stimulate glucose uptake in skeletal muscle and suppress the release of glucose by the liver; therefore, insulin resistance of these tissues causes hyperglycemia. Persistent hyperglycemia stimulates the pancreas to increase synthesis and secretion of insulin, leading to hyperinsulinemia. Progression to frank diabetes occurs when the insulin-synthesizing  $\beta$ -cells become defective and can no longer produce sufficient insulin, and these cells may undergo programmed cell death.

A third important action of insulin is to suppress lipolysis in adipose tissue. Lipolysis is the most sensitive to the effects of insulin, and impairment in this process contributes



to the insulin resistance of the other peripheral tissues. The inability to suppress adipose tissue lipolysis results in high levels of circulating nonesterified fatty acids (NEFA). NEFA can be incorporated into lipoproteins by the liver, and elevated circulating NEFA and lipoproteins can also cause lipid accumulation in skeletal muscle. The high levels of both circulating and accumulated lipids cause defects in skeletal muscle glucose transport and insulin signaling pathways through multiple mechanisms [10, 20, 51-53]. Since insulin signaling is a primary regulator of protein synthesis and degradation pathways in skeletal muscle, insulin resistance and high circulating lipids can significantly impact muscle mass. For example, chronic hemodialysis patients with insulin resistance [54] or T2DM [55] have accelerated muscle protein loss due to an enhanced rate of protein degradation. The relationship between elevated lipids, insulin resistance, and muscle protein degradation is discussed in more detail throughout the remainder of this chapter.

### *Muscle atrophy and diabetes*

Muscle atrophy is defined as an involuntary loss of at least 5-10% of muscle mass [48]. It occurs when the rate of protein degradation exceeds the rate of protein synthesis and may result from many physiological or pathological conditions, listed in Table 2.1. It is a comorbidity common to numerous chronic illnesses, including diabetes and renal and heart failure, and it reduces functionality and quality of life. Reduced muscle mass is a primary indicator of mortality in healthy older adults and individuals with diabetes, heart and renal failure, and cancer [1, 2]. Because skeletal muscle is essential in the regulation of whole body metabolism and defects in skeletal muscle metabolism are largely

*Table 2.1. Physiological and pathophysiological conditions associated with muscle atrophy.*

<b>Aging</b>
<b>Acquired Immunodeficiency Syndrome</b>
<b>Alcohol myopathy</b>
<b>Bedrest</b>
<b>Burn injury</b>
<b>Cancer</b>
<b>Congestive Heart Failure</b>
<b>Chronic Kidney Disease</b>
<b>Chronic Obstructive Pulmonary Disease</b>
<b>Denervation</b>
<b>Diabetes</b>
<b>Disuse</b>
<b>Hypoxia</b>
<b>Mechanical Ventilation</b>
<b>Rheumatoid arthritis</b>
<b>Sedentary lifestyle</b>
<b>Sepsis</b>
<b>Spaceflight</b>
<b>Spinal Cord Injury</b>

responsible for the development of T2DM [3], this dissertation is focused on muscle atrophy in the context of T2DM.

According to the 2014 National Diabetes Statistics Report, 9.3% of Americans (29.1 million people) have diabetes, and T2DM accounts for 90-95% of all diagnosed cases [56]. It is projected that by 2025, approximately 300 million people worldwide will have diabetes [9]. Diabetes is a costly illness for both the healthcare industry and individuals afflicted with the disease. In 2012, the estimated total diabetes costs in the US were \$245 billion, and the adjusted average direct medical expenses for people diagnosed with diabetes were 2.3 times higher than people without diabetes [56]. Diabetes is the primary cause of chronic kidney disease in the US [57] and increases the risk for cardiovascular events by 2- to 4-fold and for early mortality by 60% in adults [58]. Clearly the individual and economic health burden of T2DM is enormous, and strategies targeting the prevention and treatment of diabetes comorbidities are needed.

Diabetes-related skeletal muscle atrophy has been documented in numerous observational and experimental studies [59]. Cross-sectional analysis of a subset of participants in the National Health and Nutrition Examination Survey (NHANES) III showed that the skeletal muscle index (calculated as the ratio of skeletal muscle mass to total body weight) is inversely related to insulin resistance and prediabetes prevalence [60]. Another study showed that older Dutch men with T2DM have decreased leg and appendicular muscle mass, which is related to reduced leg extension and handgrip strength and overall functional capacity [61]. Similarly, Japanese adults with T2DM have reduced total body and lower limb skeletal muscle mass compared to adults matched for age, gender, and body mass index [62]. However, the cross-sectional nature of these

studies limits the ability to assess whether diabetes plays a causative role in the development of muscle atrophy. To address this, one group followed older American adult participants with or without T2DM in the Health, Aging, and Body Composition Study for 3 years and found that those with T2DM experienced accelerated loss of leg muscle mass and strength compared to those without T2DM [63]. The reduction in muscle mass with diabetes appears to be primarily due to an increase in protein degradation. Assessment of protein balance in fasted chronic hemodialysis patients with or without T2DM using labeled leucine and phenylalanine showed that the rate of protein catabolism was increased by 85% in T2DM patients [55]. Several animal models also support the diabetes-induced functional and morphometric alterations in skeletal muscle [64, 65] and indicate that diabetes-related muscle atrophy is due to an increase in the rate of muscle protein degradation [66]. Thus, prevailing evidence suggests that diabetes causes muscle atrophy. Given the crucial role of skeletal muscle in nutrient and whole-body metabolism it is apparent that muscle atrophy is a particularly detrimental comorbidity that likely exacerbates the pathological characteristics of T2DM. This highlights the need for effective treatments that can target metabolic processes that contribute to both muscle atrophy and T2DM.

### **PROTEOLYTIC SYSTEMS IN SKELETAL MUSCLE**

Cellular proteins are continually recycled by being degraded and replaced. Individual proteins in the cytosol, nucleus, ER, and mitochondria have half-lives that vary considerably depending on their function. For example, the turnover rates of myofibrillar proteins (i.e. myosin, actin) are several times slower than that of non-myofibrillar proteins because of the way they are organized into complex multi-protein structures

[67]. Protein degradation and synthesis pathways occur independently at rates which vary substantially depending on physiological demand [47]. During diseases and other catabolic states, the loss of lean body mass typically results from acceleration of the degradation of muscle proteins [45]. Multiple proteolytic systems contribute to the degradation of proteins in skeletal muscle, including the ubiquitin-proteasome, autophagy-lysosome, caspase, and calpain pathways. Notably, the ubiquitin-proteasome, autophagy-lysosome, and caspase-mediated proteolytic systems are regulated by common upstream molecular signaling pathways, which will be discussed at the end of this section. As a consequence, the activities of all three systems are frequently increased by the same initiating stimuli.

#### Ubiquitin-proteasome system

The ubiquitin-proteasome (UbP) system degrades ~80-90% of intracellular protein, including abnormal proteins and normal short- and long-lived proteins [47, 68, 69]. In muscle, this includes both sarcoplasmic and myofibrillar proteins, though the latter cannot be digested in intact myofibrillar complexes and must be cleaved by other proteolytic systems prior to proteasomal degradation. During chronic illness-induced atrophy, the UbP is the primary system responsible for the accelerated degradation of myofibrillar proteins [70].

In the UbP pathway, protein substrates are modified by covalent attachment of a polyubiquitin chain, which targets them for destruction by the proteasome in a highly-regulated, ATP-dependent process (**Fig. 2.2**) [69]. Because cellular function can be radically altered by aberrant regulation of protein turnover, the proteolytic machinery is very selective and precisely controlled [45]. For the UbP pathway, this specificity is

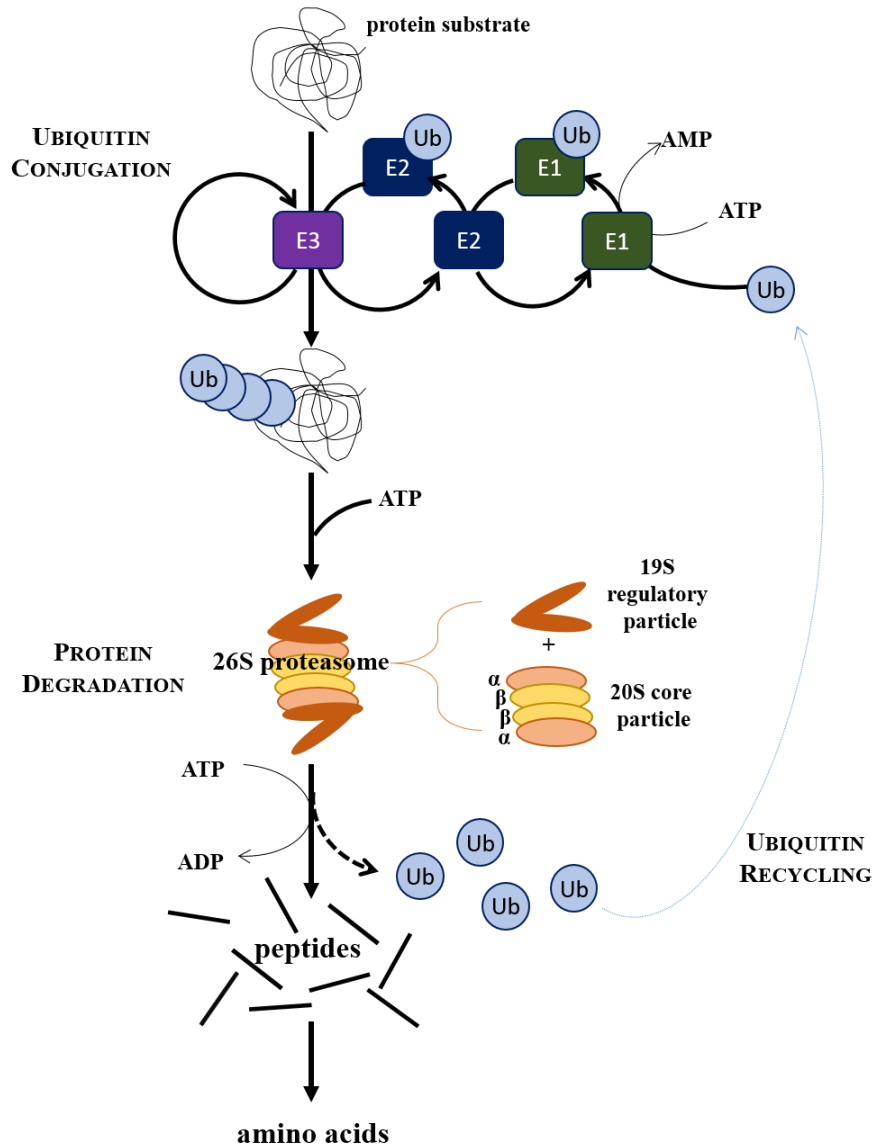

**Figure 2.2. The ubiquitin-proteasome system.** Proteins are tagged with ubiquitin in a series of enzymatic reactions. The 26S proteasome rapidly degrades polyubiquitinated proteins into short peptides, which are subsequently cleaved to amino acids by cytosolic peptidases. Ubiquitin is recycled for use in subsequent conjugation reactions.

ensured at multiple levels, including the structural organization of the proteasome and the highly-specific process of ubiquitin conjugation.

### *Ubiquitin conjugation*

The conjugation of the small 76 amino acid polypeptide ubiquitin (Ub) to protein substrates is the rate-limiting step of the UbP pathway. First, Ub is activated by the E1 Ub-activating protein. E1 uses ATP to form a highly-reactive carboxy-terminal Ub adenylate. The high-energy Ub is then transferred to the E1 active site, releasing AMP. Next, the activated Ub is transferred from E1 to one of the numerous E2 Ub-carrier (also known as Ub-conjugating) proteins. Finally, Ub is transferred from E2 to the protein substrate by one of a large family of E3 Ub-protein ligases. E3 ligases are responsible for selecting the proteins to be degraded by recognizing various structural elements, such as specific amino acid sequences and/or specific structural or phosphorylated domains. They contain specific binding sites for E2, the protein substrate, and at least one Ub molecule. The E3 ligase catalyzes the transfer of the activated Ub from E2 to the protein substrate by forming an isopeptide bond between the activated Ub and a specific lysine residue in the protein substrate. This process is repeated to form polyubiquitin chains; the same enzymes processively add activated Ub to specific lysine residues in the previously attached Ub molecule. Proteins tagged with at least four Ub molecules are rapidly degraded by the proteasome (**Fig. 2.2**). While only one functional E1 has been identified, the genome contains a few dozen E2s and over five-hundred E3s. The E3 alone or in complex with E2 is considered to provide the specificity of the ubiquitination process [45, 47, 69, 71].

Generally, E3s fall under two main classes. The smaller of the two classes are the E3s that contain HECT (homologous to E6-AP carboxy terminus) domains and directly bind to and transfer activated Ub to the protein target. Most E3 ligases contain RING finger domains, 40-60 residue zinc-binding motifs with core cysteine and histidine amino acids in a C3HC4 “RING” arrangement [71]. These proteins are typically found in a multi-subunit complex which exhibits Ub ligase activity. The prototype of the modular E3s is the SCF complex, which contains Skp1, a Cullin protein, a RING finger protein, and an F-box protein [72]. The F-box protein binds to the target protein prior to binding to Skp1 [71] and thus serves as the substrate recognition component of the complex [73]. Cullin is the main scaffold that brings together the entire E3 complex by binding to both Skp1 and a fourth subunit, Rbx1. The RING finger domain of Rbx1 binds to Cullin, and another portion of the Rbx1 protein binds the E2-Ub complex [71].

#### *Muscle-specific E3 ligases*

The expression pattern of E3 ligases varies between tissues and changes under varying physiological conditions. In 2001, two groups published that the transcripts of two E3 ligases are highly induced specifically in atrophying skeletal muscle [74, 75]. Using tissue from rats subjected to denervation, unweighting, and immobilization or treated with interleukin-1 or the synthetic glucocorticoid dexamethasone, Bodine et al. [74] showed that transcripts for muscle RING finger 1 (MuRF1) and muscle atrophy F-box (MAFbx) are upregulated in various models of atrophy. At the same time, Gomes and colleagues [75] identified another muscle-specific E3 ligase that was increased in muscle tissue of fasted, uremic, tumor-bearing, and diabetic mice, which they termed atrogin-1.



Sequence analysis of atrogin-1 revealed that it is 96% homologous to the rat MAFbx gene, suggesting that it is the mouse homologue of rat MAFbx. Subsequent studies showed that these E3s are also increased in human muscle due to disuse atrophy [76]. Knockout of MuRF1 or atrogin-1/MAFbx in mice does not cause an obvious phenotype in the absence of an atrophy-inducing stimulus, however they are protected to varying degrees from denervation-induced atrophy [74]. Together these studies revealed that MuRF1 and atrogin-1/MAFbx are among a common set of atrophy-regulated genes, termed *atrogenes*, that are altered during the complex program of transcriptional changes that occur in many different types of muscle atrophy [70].

Atrogin-1/MAFbx (hereafter referred to as atrogin-1) is a 42 kDa protein with an F-box domain, suggesting that it forms the substrate recognition portion of a larger SCF complex. It also contains a nuclear localization sequence and domains for binding PDZ proteins and cytochrome *c* but does not contain any obvious motifs to indicate possible ubiquitination targets [75]. Several studies have demonstrated that atrogin-1 ubiquitinates and degrades MyoD and elongation initiation factor 3 subunit 5 (eIF3-f) in skeletal muscle [77-79], and other substrates are currently under investigation.

MuRF1 is a 40 kDa protein which contains an N-terminal RING finger domain and two central coiled-coil domains [71, 80]. Unlike most other ligases in this class, MuRF1 has Ub conjugating activity without forming a complex with other proteins [74]. While the full array of MuRF1 targets has not yet been elucidated, it appears to preferentially interact with structural muscle proteins. MuRF1 may bind and regulate the kinase activity of titin [80] and is required for degradation of myosin heavy chain, myosin-binding

protein C, and myosin light chains 1 and 2 in response to denervation and fasting in mice [81].

### *The proteasome*

Ub-conjugated proteins are degraded by the 26S proteasome, a ~25,000 kDa particle comprised of a 20S core and a 19S regulatory complex. The 20S core particle is a ~600 kDa barrel-shaped structure made up of 4 stacked rings, each with seven subunits. The two outermost rings are comprised of  $\alpha$  subunits, while the two inner rings are made of  $\beta$  subunits. The outer rings form small openings where unfolded proteins enter the proteasome. The two middle rings form a cavity where the proteins are degraded. The catalytic  $\beta$ 1,  $\beta$ 2, and  $\beta$ 5 subunits contain at least 3 active sites that differ in their specificity for substrates. The sites preferentially cleave after either basic, large hydrophobic, small neutral, or acidic residues and therefore together catalyze the complete digestion of polypeptides into small peptide fragments ranging from 3-25 amino acids in length. The peptides are subsequently released into the cytosol and degraded into single amino acids [45, 47, 69].

The large (~700 kDa) 19S regulatory complex can associate with one or both ends of the 20S core particle. It provides specificity to the proteolytic process by binding the ubiquitinated substrates and catalyzing their entry into the core. The 19S complex contains at least 6 different ATPases and is divided into lid and base portions. The lid binds and removes the polyubiquitin chains from the tagged substrate. The ubiquitin chains are disassembled by the proteasome and released for subsequent proteolytic

cycles. The base portion uses the energy from ATP hydrolysis to unfold and inject the protein substrates into and to activate the 20S core particle [45, 47, 69].

### Caspase-mediated proteolysis

Cysteine-dependent, aspartate-directed proteases (i.e. caspases) are an important proteolytic system in skeletal muscle because they cleave a wide spectrum of cytosolic targets [82]. In particular, the bulk of muscle protein exists in myofibrils which cannot be degraded in their intact forms. Caspase-mediated cleavage is an important initial step in degradation of these proteins, which are typically processed by the UbP. Du and colleagues [83] showed not only that caspase-3 cleaves actin in actomyosin to form a characteristic 14 kDa actin fragment along with other proteins that are degraded by the UbP, but also that cleaved actin fragments are found in muscle of rats with atrophy due to diabetes and uremia and that the addition of a caspase-3 inhibitor prevents the accumulation of the fragment in diabetic rats [83]. Inhibition of caspase-3 has also been shown to attenuate disuse atrophy in the diaphragm due to mechanical ventilation [84], and treatments that reduce caspase-3 activation in hindlimb suspended animals attenuates loss of plantaris and soleus myofiber cross-sectional area [85]. Lastly, the rate of protein degradation, proteasome chymotrypsin-like activity, and caspase-3-mediated actin cleavage were all reduced in transgenic mice overexpressing the endogenous caspase inhibitor XIAP (X-chromosome-linked inhibitor of apoptosis) in skeletal muscle, and the muscle wet weight in these animals was similar to wild-type mice [86]. Together these studies suggest that activation of caspase-3 is an important step in the progressive loss of muscle protein due to catabolic stressors.

Caspase-3 is activated by upstream caspases that are involved in both the extrinsic (death receptor-initiated) and intrinsic (cytosolic) caspase cascades [87]. Each cascade involves the release of cytochrome *c* and other factors from the mitochondria by enhancing the activity of permeability pores in the outer membrane. The process is regulated by various members of the Bcl-2 protein family [88]. For example, the anti-apoptotic protein Bcl-2 binds to the pro-apoptotic protein Bax and prevents Bax from facilitating pore formation; this process is antagonized by pro-apoptotic Bad which binds to Bcl-2 and prevents its association with Bax [89]. Release of cytochrome *c* from mitochondria induces the formation of a signaling complex that activates caspase-9 and subsequently caspase-3 (**Fig. 2.3**) [87]. However, skeletal muscle cells are different than most other cell types because they are post-mitotic and multinucleated, and activation of apoptotic pathways in the traditional sense does not cause loss or death of the entire muscle cell or fiber. While the loss of individual myonuclei in skeletal muscle atrophy is a highly-debated area and depends greatly on the atrophy model/stimulus [49], it is clear that the activation of caspase-3 is a key factor that triggers the progressive loss of muscle protein in catabolic illness [83].

### Autophagy-lysosome system

#### *Lysosomal degradation*

Lysosomes are membrane-bound vesicles with an acidic internal environment that contain an assortment of hydrolases that degrade a variety of molecules [90]. At least a dozen lysosomal proteases, known as cathepsins, work together to fully degrade proteins to amino acids [91]. Lysosomes are the end-point of pinocytosis, endocytosis,

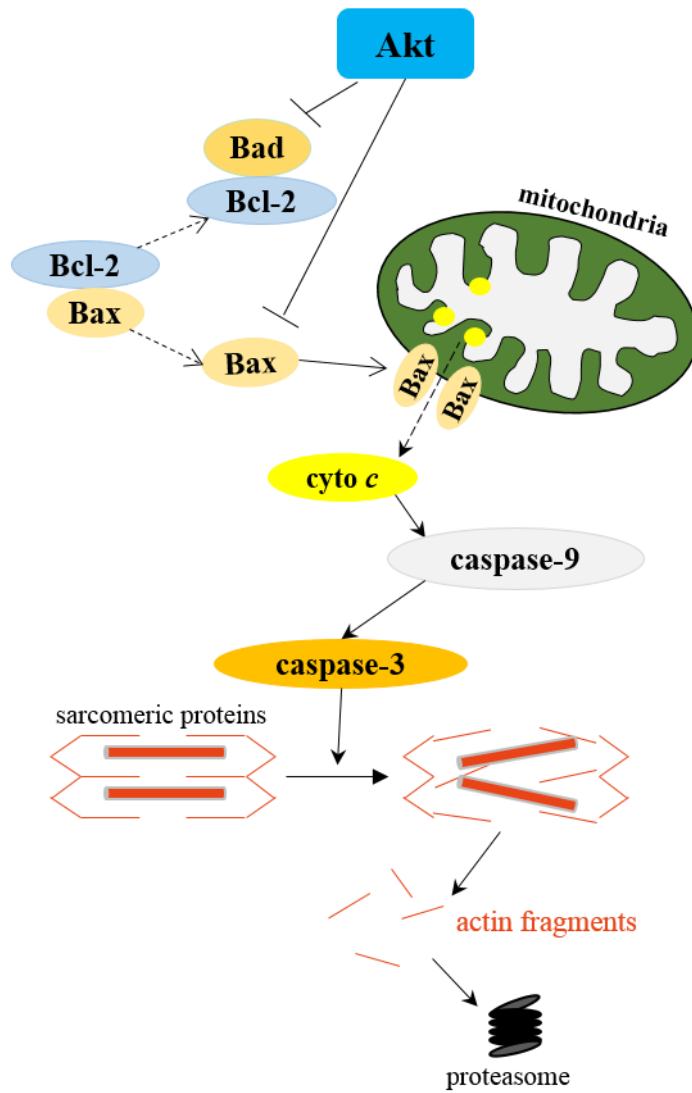

**Figure 2.3. Caspase-mediated proteolysis.** Mitochondrial stability and the activation of caspase-3-mediated actin fragmentation is regulated by interactions between various pro- and anti-apoptotic proteins of the Bcl-2 family.

phagocytosis, and autophagy pathways [90]. The cell uses four main mechanisms to regulate the entry of substrates into the lysosome: 1) plasma membrane proteins are endocytosed and fuse with endosomes which are trafficked to the lysosome; 2) selected proteins are directly transported through the lysosomal membrane in a chaperone-mediated process; 3) small amounts of cytoplasm are sequestered into the lysosome via budding and internalization of the lysosomal membrane (i.e. microautophagy); and 4) cytoplasm and organelles, including mitochondria and sarcoplasmic reticulum, are sequestered in double-membrane vesicles called autophagosomes, which fuse with endosomes and are trafficked to lysosomes (i.e. macroautophagy). The latter is quantitatively the most important of these four processes [91].

The lysosomal system is critical for cellular homeostasis because it facilitates the removal of protein aggregates, controls the turnover of organelles, and contributes to the breakdown of long-lived cytosolic, membrane, and endocytosed proteins [45, 47, 90]. Compared to the other proteolytic systems, lysosomes are particularly poised to degrade stroma proteins, such as those bound in the membrane or located in the extracellular matrix, which have entered the cell through pinocytosis or receptor-mediated endocytosis [47, 92]. The lysosomal system does not degrade myofibrils [67] and is therefore not quantitatively important in the accelerated breakdown of myofibrillar proteins during muscle atrophy [45]. However, it does contribute to overall proteolysis during atrophy. One of the first studies to quantify the contribution of this system to total protein degradation in rat skeletal muscle showed that lysosomal proteolysis of nonmyofibrillar proteins contributes to 25-35% of total protein degradation in response to brief starvation [67].

### *Autophagy*

There are few studies examining microautophagy and chaperone-mediated autophagy in muscle, so it is unknown whether these processes play important roles in protein metabolism, especially during atrophy. The majority of studies in skeletal muscle have examined the process of macroautophagy [90]. Macroautophagy (hereafter termed autophagy) involves membranes originating from the sarcolemma, mitochondria, ER, and possibly T-tubules, growing into double-membrane vesicles that engulf portions of the cytoplasm, organelles, glycogen, and protein aggregates. The vesicles eventually fuse with the lysosome and the contents undergo hydrolysis by the lysosomal enzymes [90]. There are six main steps in the autophagy process. The induction of autophagy involves 1) initiation and 2) nucleation; the autophagosome is formed by 3) elongation and 4) closure; the autophagosome matures when it 5) fuses with the lysosome; and finally the contents of the autophagosome are 6) degraded by hydrolysis with lysosomal enzymes [93]. Several small, Ub-like protein factors (LC3, GABARAP, GATE16, and Atg12) are required for nucleation and elongation of membranes into autophagosomes. These proteins are covalently bound to phospholipids on the inner and outer portions of the growing membrane [90]. Two other essential proteins involved in autophagosome elongation include Atg (autophagy-related) 5 and Atg7 [93].

The process of nucleation and elongation is remarkably similar to Ub conjugation. The addition of LC3 (microtubule-associated protein light chain 3) and Atg12 to the growing membrane requires the activating enzyme Atg7. Atg7 converts Atg12 and LC3 to high-energy molecules and transfers them to other Atgs that function similarly to E2 carrier proteins. Atg12 is conjugated to its substrate Atg5, which associates with membranes and

forms an E3-like complex that transfers LC3 to phosphatidylethanolamine [91]. The Atg7-mediated cleavage of LC3 and its binding to phosphatidylethanolamine (i.e. lipidation) is detectable as a lower molecular weight protein, LC3-II [94]. LC3-II binds to the cargo adaptor protein p62 which tags intracellular targets for autophagy, thus serving as a docking site for autophagic substrates (**Fig. 2.4**) [95]. Therefore, LC3 promotes the budding of the membrane and closure of the autophagosome, and its processing to LC3-II is indicative of autophagosome formation [90, 93].

The role of autophagy in muscle atrophy has been largely unrecognized until recently. In particular, studies have shown that the autophagy-lysosome system is central in the removal of damaged organelles from muscle. For example, the mitochondria are specifically targeted for sequestration in an autophagosome and ultimately degraded in the lysosome via “mitophagy” (**Fig. 2.4**) [90]. While a basal level of autophagy is required to maintain cell survival and organelle turnover [96, 97], it appears that excessive autophagy is detrimental to muscle mass [90]. Conditions that cause muscle atrophy may induce excessive autophagy by damaging the mitochondria. For example, denervation and fasting induce radical changes in dimension and shape of mitochondria and trigger mitophagy. This atrophy-related remodeling of the mitochondrial network is induced by an increase in the expression of Bnip3 [97]. Bnip3 (Bcl2 and adenovirus E1B 19-kDa-interacting protein 3) is a member of the Bcl2 superfamily. It contains a BH3 domain and a C-terminal transmembrane domain, the latter of which is required for mitochondrial localization [98]. Bnip3 has been shown to trigger mitochondrial



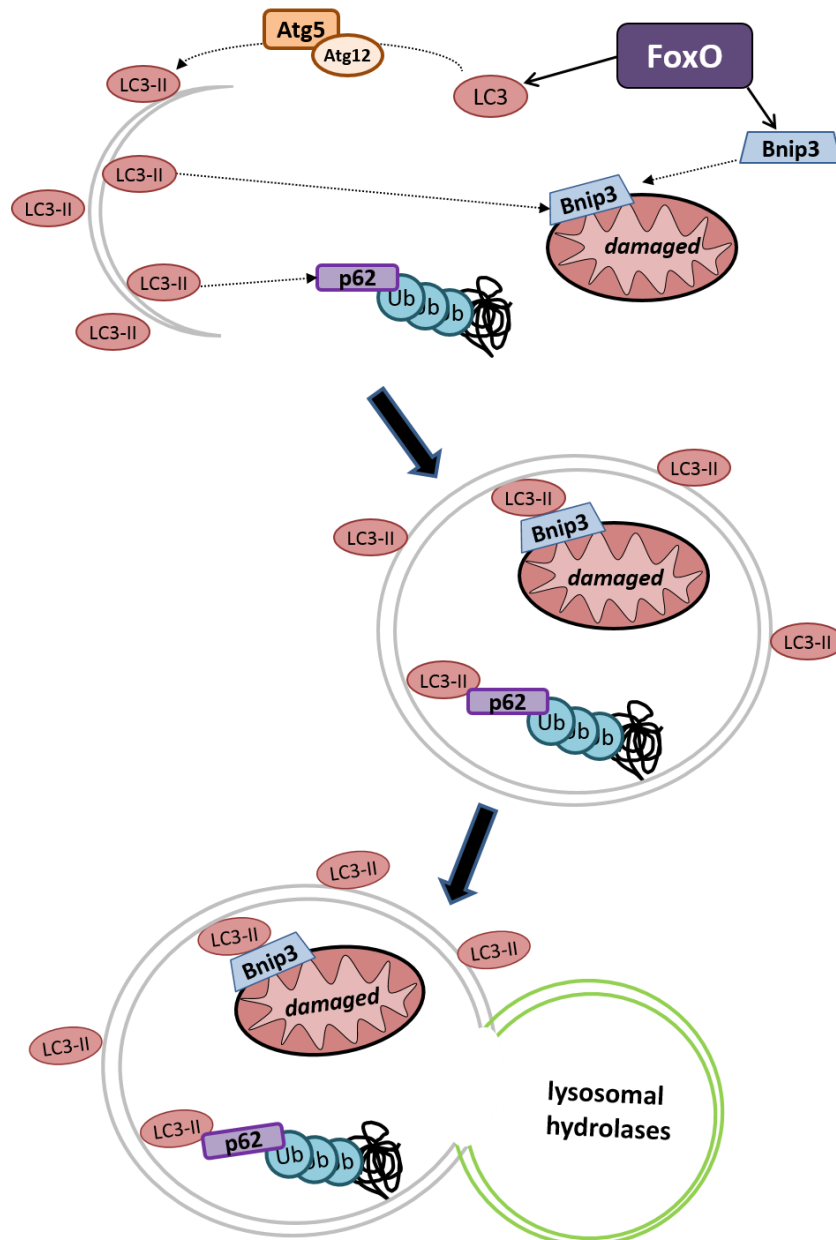

**Figure 2.4. The autophagy-lysosome system.** FoxO3 regulates Bnip3 and LC3, which promote the sequestration of damaged mitochondria and intracellular proteins by the autophagosome. Upon fusion with lysosomes, the autophagosomal contents are degraded by lysosomal enzymes.

depolarization, which is sufficient to cause mitophagy [98]. Bnip3 also binds LC3-II, thus directing the growing autophagosome to the mitochondria [95].

### Calpains

The fourth proteolytic system in skeletal muscle is the calpain superfamily of calcium-responsive cytosolic cysteine proteases. Approximately seven different calpains are expressed in skeletal muscle, and their expression and activity are an important component of adaptive changes in muscle related to contractile activity. Calpain activity may be important in the release of myofibrillar components during some models of atrophy, but this system appears to be more important for the continual turnover and remodeling of myofilaments and is not generally recognized as contributing significantly to the accelerated degradation of muscle protein which occurs in numerous chronic illnesses [47, 91]. Moreover, the regulation of calpains by alterations in cellular calcium levels is substantially different than the UbP-, capase-, and autophagy- systems which share common upstream regulators and initiating stimuli.

### Regulation of proteolysis in skeletal muscle

The insulin/IGF1 (insulin-like growth factor 1) pathway is a critical regulator of cell growth and differentiation and muscle mass. Binding of insulin/IGF1 to its receptor recruits several proteins to the receptor and activates a number of intracellular kinases. One of the responses involves the recruitment of insulin receptor substrate 1 (IRS1), which induces the activation of phosphatidylinositol 3-kinase (PI3K). PI3K phosphorylates the membrane phospholipid phosphatidylinositol-4,5-bisphosphate, resulting in the formation of phosphatidylinositol-3,4,5-triphosphate and the creation of a

lipid binding site on the membrane for the serine/threonine kinase Akt (also known as PKB). Translocation of Akt to the membrane facilitates its phosphorylation and activation by phosphoinositide-dependent kinase 1 (PDK-1). Akt in turn phosphorylates numerous downstream targets which are essential for cell growth and survival [99].

The insulin-IGF1/PI3K/Akt pathway is an important regulator of muscle mass. For instance, incubating myotubes with IGF1 for 24-48 hours results in hypertrophy as indicated by a significant increase in myotube diameter or protein content per myotube [99, 100]. Furthermore, overexpression of a dominant-negative kinase-inactive Akt reduces myotube diameter, while overexpression of constitutively active Akt induces hypertrophy of myotubes *in vitro* [100] and of both normal and denervated rat tibialis anterior muscle *in vivo* [101]. Lastly, inhibition of the Akt target mTOR prevents an increase in plantaris mass during compensatory hypertrophy in rats and mice [101].

Reduced insulin/IGF1 signaling through Akt is a common response in atrophy models, such as diabetes, chronic kidney disease (CKD), and metabolic acidosis. This involves derangement in immediate post-receptor signaling events. Bailey and colleagues [102] showed that the CKD-induced suppression of basal IRS1-associated PI3K activity and Akt activation is at least in part due to an acidosis-induced increase in the PI3K p85 subunit protein without a similar increase in the p110 catalytic subunit. Zheng et al. [103] also found that that the PI3K p85 regulatory but not p110 catalytic subunit is increased in myotubes following treatment with the synthetic glucocorticoid dexamethasone (Dex) as well as showed that the level of IRS1 protein is reduced by Dex. Additionally, they demonstrated that IRS1 protein and Akt activation are decreased and atrogen-1 mRNA is increased in skeletal muscle from diabetic rats [103].

Suppression of Akt signaling can result in the loss of muscle protein through up-regulation of the UbP, autophagy-lysosome, and caspase-mediated proteolytic systems [83, 89, 102, 104], and accelerated proteolysis is the primary cause of muscle mass loss during atrophy [105]. Akt is an important regulator of the Forkhead box O (FoxO) transcription factors, targeting three of the four FoxOs (-1, -3, and -4) [106, 107]. The Akt-dependent phosphorylation of FoxO3 generates binding sites for 14-3-3 [108], causing its extrusion from the nucleus and preventing its ability to mediate transcription [109]. FoxO proteins induce the expression of several key atrogenes, including the muscle-specific E3 ligases MuRF1 and atrogin-1 and the autophagy mediators Bnip3 and LC3 [103, 107, 109]. These mRNAs are linked to muscle atrophy in a variety of disease models [103, 109, 110], and their targeted inactivation reduces muscle loss [48, 70, 74].

Treating myotubes with IGF1 reduces total and myofibrillar protein degradation and atrogin-1 and MuRF1 mRNAs, and IGF1 also prevents the increase in atrogin-1, MuRF1, and cathepsin L mRNAs induced by pre- or co-treatment with Dex. The effect on atrogin-1 appears to be mediated by PI3K/Akt, as specific inhibitors of PI3K or the Akt target mTOR result in an increased level of atrogin-1 mRNA and an increased rate of protein degradation [105]. In mice, overexpression of constitutively active (ca-) Akt suppresses atrogin-1 transcription both basally and in response to fasting. Atrogin-1 transcription is also prevented by mutation of the Akt phosphorylation site in FoxO3, and overexpression of dominant-negative (dn-) FoxO prevents the induction of atrogin-1 induced by fasting in mice or by Dex in myotubes [109]. Overexpression of ca-FoxO also induces autophagosome formation in mouse skeletal muscle [107, 111] and the lipidation of LC3 in myotubes, while ca-Akt or dn-FoxO prevent autophagosome formation, LC3

lipidation, and the increase in Bnip3, LC3, and cathepsin-L mRNAs induced by fasting and denervation [107]. Therefore, the Akt/FoxO axis represents a mechanism for coordinated regulation of proteasomal and lysosomal proteolysis in atrophying skeletal muscle [111].

The insulin-IGF1/PI3K/Akt pathway can also suppress the activity of caspase-3 by several mechanisms. Du et al. [83] found that insulin inhibits the formation of the actin fragment in serum-starved cultured myotubes in a PI3K-dependent mechanism, since addition of the PI3K inhibitor LY294002 blocks the inhibition of actin cleavage by insulin [83]. A subsequent study showed that PI3K suppresses the activation of caspase-3 by inhibiting the activation of Bax and the release of cytochrome *c* from the mitochondria [104]. In a different study, reduction of serum from 2% to 0.5% overnight stimulated caspase-3 activation and actin cleavage in cultured rat myotubes [89]. The response was also inhibited by the addition of insulin, via PI3K/Akt-mediated inhibitory phosphorylation of Bad on Ser-112 as well as direct association of caspase-3 with CIAP1 (cellular inhibitor of apoptosis protein 1) [89].

#### **ENDOPLASMIC RETICULUM STRESS AND THE UNFOLDED PROTEIN RESPONSE**

In eukaryotic cells, the ER is responsible for numerous cellular processes, including modification and quality control of proteins, lipid and cholesterol biosynthesis, and calcium homeostasis. The ER is a membranous network that extends through the cytoplasm of the cell. It adjoins the nuclear envelope and is in close proximity to the mitochondrial reticular network [112] and has the ability to sense and transmit signals generated by any compartment of the cell [113]. The structure of the ER is

heterogeneous, with specialized regions localized to areas of the cell where it performs various functions. In general, the ER is divided into nuclear membrane, smooth ER, and rough ER. The smooth ER is involved in calcium signaling and is in close proximity to the mitochondria. In muscle cells, this region of the ER is called the sarcoplasmic reticulum (SR) and is responsible for generating the global signals necessary for muscle contraction [114]. As extension of the nuclear membrane, the rough ER is in close proximity to the nucleus. This portion of the organelle is highly involved in the folding, processing, and trafficking to the cell surface of all proteins that are destined to be secreted or membrane-bound. The total concentration of proteins in the ER can reach 100 mg/ml [115]. Interference in the protein folding process and accumulation of misfolded or unfolded proteins results in ER stress. A highly-specialized set of signaling events are triggered in response to ER stress, termed the unfolded protein response (UPR). These pathways ensure that ER protein folding capacity is not overwhelmed by balancing the folding capacity of the ER with its protein load [116] via transcriptional induction of genes encoding ER resident proteins needed for protein folding as well as rapidly decreasing the generation of newly synthesized proteins [117].

The UPR is comprised of three distinct arms which are activated by the stress transducing proteins inositol-requiring enzyme 1 alpha (IRE1 $\alpha$ ), activating transcription factor-6 (ATF6), and double stranded RNA-activated protein kinase R-like ER protein kinase (PERK). These integral membrane proteins contain an ER luminal domain that senses the protein folding environment and a cytoplasmic domain that associates with transcriptional and/or translational machinery [117]. Under basal conditions they are normally inactive due to their interactions with the protein chaperone BiP (also known as

Grp78, HspA5). In response to ER stress-inducing stimuli such as accumulation of misfolded/unfolded proteins, the stress transducers become activated via dissociation from BiP [118] and signal distinct downstream responses which are integrated through extensive cross-talk between the effectors [117]. Prolonged or severe ER stress leads to sustained activation of these pathways and can result in cell death via apoptosis mediated by all three arms of the UPR (**Figure 2.5**).

#### The ATF6 pathway

Activating transcription factor 6 (ATF6) is a mammalian-specific ER stress transducer. It is constitutively expressed as a 90-kDa type II transmembrane glycoprotein tethered to the ER membrane by a hydrophobic sequence in the middle of the molecule. Under ER stress conditions, dissociation of ATF6 from BiP reveals a Golgi localization sequence [119] that relocates it to the Golgi apparatus where it is cleaved by resident proteases, releasing the soluble cytosolic 50-kDa active fragment of ATF6 which can translocate to the nucleus to alter gene expression [120, 121]. Active ATF6 is a member of the basic leucine zipper (bZIP) transcription factor family. Its gene targets include ER quality control proteins that are involved in the adaptation to stress, such as BiP and protein disulphide isomerase [121, 122]. ATF6 also enhances the transcription of X-box binding protein 1 (XBP1) mRNA, an important cellular target of IRE1 $\alpha$  [123, 124].

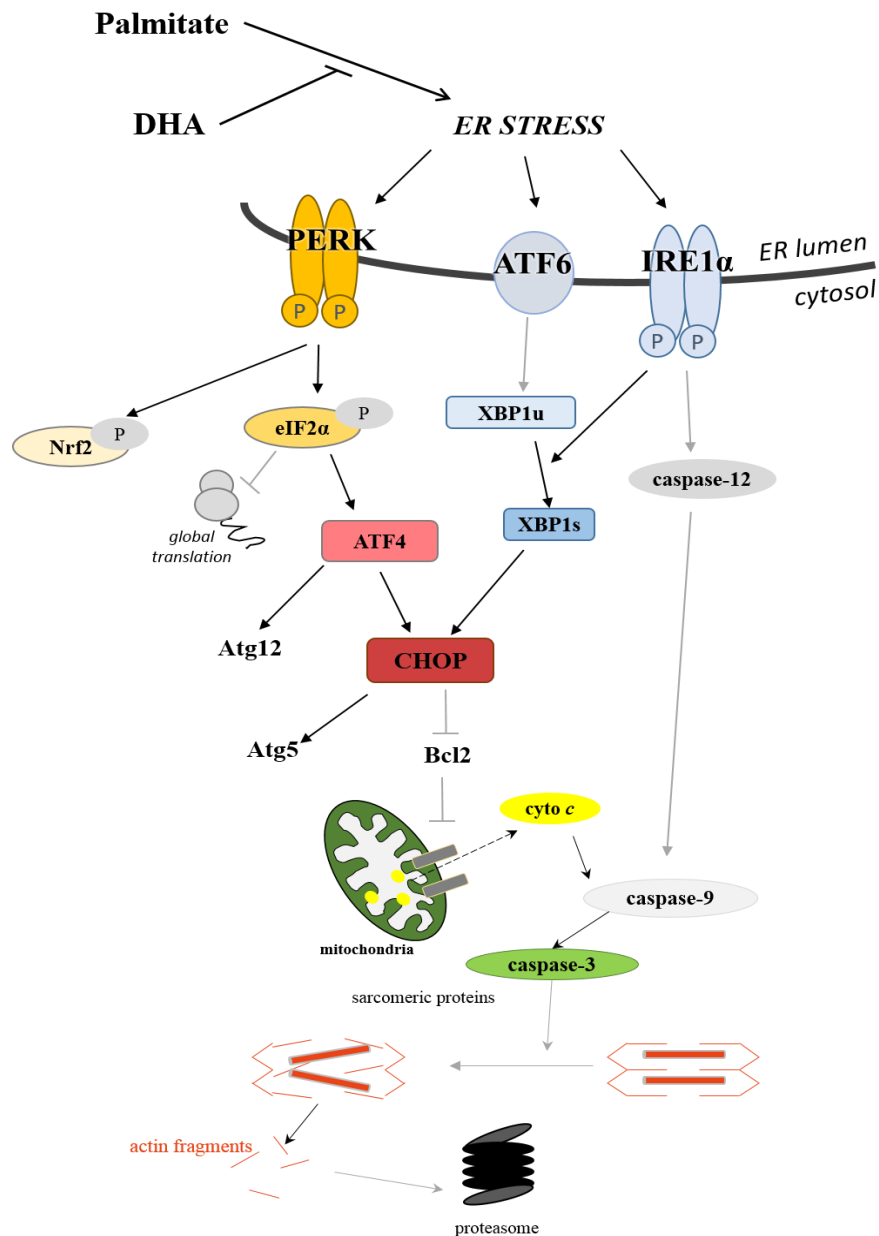

**Figure 2.5. Endoplasmic reticulum stress and the unfolded protein response.** ER stress activates three stress sensors which transduce signals that stimulate adaptive responses including suppression of global protein translation and ER associated degradation. In response to prolonged or severe ER stress, the signals become maladaptive and ultimately result in the activation of caspase-3.



### The IRE1 $\alpha$ -XBP1 pathway

Inositol requiring enzyme/endonuclease 1 (IRE1 $\alpha$ ) is a type 1 transmembrane protein that was the first identified stress transducer in yeast [117] and is conserved in all known eukaryotes [116]. ER stress causes the luminal portion of IRE1 $\alpha$  to dissociate from BiP [118], allowing for oligomerization and trans-autophosphorylation of the cytosolic domains [123, 125]. IRE1  $\alpha$  is unique because its cytosolic portion also possesses endonuclease activity, which is triggered by its kinase activity in response to ER stress [126]. IRE1 $\alpha$  carries out a unique mRNA processing step by splicing a 26 nucleotide intron from XBP1 mRNA. The resulting mRNA product encodes an active bZIP transcription factor, spliced XBP1 (XBP1s) [116, 123].

The gene targets regulated by XBP1s during the UPR encode proteins involved in ER quality control, biogenesis of ER and Golgi, redox homeostasis, and ER associated degradation, highlighting that they operate to achieve short-term adaptation to ER stress and ultimately reestablish ER function [4, 127, 128]. Yoshida and colleagues showed that activation of IRE1 $\alpha$  is not sufficient to cause an increase in the level of spliced XBP1 mRNA but that the ATF6-mediated increased mRNA expression of the unspliced XBP1 gene product is required for IRE1 $\alpha$ -mediated generation of XBP1s [123]. Considering the low expression of XBP1 mRNA in unstressed cells [129], this highlights an important integration of the ATF6 and IRE1 $\alpha$  arms of the UPR.

### The PERK-eIF2 $\alpha$ -ATF4 pathway

An initial event in the adaptive response to ER stress is a rapid and substantial suppression of protein synthesis [117, 130]. In eukaryotes, translation initiation via

binding of initiator tRNA to the 40S subunit is primarily mediated by eukaryotic initiation factor 2 (eIF2). eIF2 forms a stable ternary complex with GTP and Met-tRNA<sub>i</sub><sup>Met</sup> and provides the GTPase activity necessary to hydrolyze GTP upon binding of the mRNA and 60S subunit. At the end of each initiation cycle, eIF2 is in an inactive conformation bound to GDP and requires the guanine nucleotide exchange factor eIF2B to recycle it to the GTP-bound form. Phosphorylation of the alpha subunit of eIF2 converts it from a substrate to an inhibitor of eIF2B, thus obstructing general translation initiation by reducing the available eIF2•GTP•Met-tRNA<sub>i</sub><sup>Met</sup> complex [131].

Four eIF2 $\alpha$  kinases have been identified which phosphorylate the initiation factor on serine 51. Heme regulated inhibitor (HRI) kinase, protein kinase R (PKR), general control non-derepressible-2 (GCN2), and PERK share a conserved kinase domain but contain distinctive regulatory domains. This allows them to phosphorylate eIF2 $\alpha$  in response to different stimuli [131, 132] and activate a common set of target genes that comprise an integrated stress response [133].

PERK initiates signaling events that suppress global protein synthesis and promote cell survival, though prolonged or severe ER stress causes PERK-dependent cell death. PERK is required for the adaptive response to ER stress, as mutation of the PERK gene impairs the ability of cells to survive ER stress via inability to limit synthesis of new proteins [134]. PERK is a type I transmembrane ER-resident protein whose N-terminal luminal domain contains similar sequence identity to IRE1 $\alpha$  [130]. Regulation of PERK activation is similar to the other UPR arms. ER stress causes dissociation of PERK from BiP [118]. This allows PERK dimerization and autophosphorylation of the C-terminal cytosolic domain, resulting in activation its protein kinase activity. Active PERK induces

a rapid and substantial decrease in protein synthesis by phosphorylating eIF2 $\alpha$ , thereby suppressing global protein synthesis to reduce ER client protein load [130].

In addition to reducing general translation initiation, serine 51 phosphorylation of eIF2 $\alpha$  has a special role in enhancing the translation of a subclass of mRNAs [131], including several whose cognate proteins aid in resolving ER stress. The PERK/eIF2 $\alpha$  pathway preferentially enhances the translation of the bZIP family activating transcription factor 4 (ATF4, also known as CREB-2) [135]. Some ATF4-target gene products participate in the import and metabolism of amino acids and protection against oxidative stress. Notably, if cell stress is not resolved, ATF4 switches from a survival signal to promote cell death by inducing gene expression of CCAAT-enhancer binding protein (C/EBP) homologous protein (CHOP) [136]. ATF4 is required for this process, as CHOP expression is ablated in ATF4<sup>-/-</sup> cells [133]. CHOP is discussed in more detail in a subsequent section of this chapter.

#### The PERK-Nrf2 pathway

The Cap'n'Collar-bZIP transcription factor nuclear factor erythroid 2-related factor (Nrf2) is a direct substrate of PERK [137]. In a basal unstimulated state, Nrf2 is bound in the cytosol to Kelch-like ECH-associated protein 1 (KEAP1) [138] which promotes its ubiquitin conjugation and proteasomal degradation [139]. PERK-mediated Nrf2 phosphorylation is necessary and sufficient to promote its dissociation from KEAP1 and nuclear translocation [137]; the dissociation from KEAP1 prevents its degradation and increases the total cellular level of Nrf2 [139].

Nuclear Nrf2 binds preferentially to the cis-acting antioxidant response element in the promoter region of antioxidant and phase II enzyme genes and is a central integrator of the cellular response to oxidative stress [138, 140]. Targeted deletion increases susceptibility to ER stress-induced apoptosis, highlighting the requirement of Nrf2 for cell survival during ER stress [137]. One mechanism by which Nrf2 promotes cell survival is by supporting the maintenance of glutathione levels to buffer reactive species generated during the UPR [141]. Overexpression of CHOP results in depletion of cellular glutathione levels while restoration of glutathione in CHOP-overexpressing cells prevents ER stress-induced cell death [142]. Furthermore, polyphenol-rich compounds such as pomegranate and green tea extracts have been shown to prevent ER stress induced by a high fat diet in skeletal muscle of mice [143], indicating that preventing the accumulation of reactive species can facilitate adaptation of the cell to ER stress instead of progressing to apoptotic cell death.

#### *ER associated degradation*

In addition to reducing protein synthesis and improving protein folding capacity, the UPR activates the ER-associated degradation (ERAD) pathway which facilitates the retro-translocation of misfolded and unfolded proteins from the stressed ER into the cytosol for degradation by the 26S proteasome [144, 145]. Multiple arms of the UPR are responsible for regulation of ERAD. Nrf2 plays a key role in regulation of ERAD components, particularly increased expression of proteasome subunits [139]. Additionally, the generation and splicing of XBP1 mRNA by ATF6 and IRE1 $\alpha$  are required for the XBP1s-mediated transcriptional induction of ER degradation-enhancing

alpha-mannosidase-like protein, which is required for the degradation of misfolded glycoprotein substrates [146].

The removal of damaged ER and insoluble protein aggregates also occurs via autophagy [127, 128]. PERK-eIF2 $\alpha$  regulation of autophagy has been demonstrated in ER stress induced by a variety of stimuli, including starvation, cannabinoids, viruses, and ectopic expression of polyglutamine proteins [127]. Unlike starvation-induced macroautophagy in which the cell degrades cytoplasmic contents in bulk to provide nutrients to the cell, it has been suggested cell survival during ER stress may depend on the sequestration of damaged ER in autophagic vesicles without immediate subsequent lysosomal hydrolysis [128]. In either case markers of autophagy initiation should be increased. In C2C5 cells, ER stress induced by thapsigargin or forced expression of polyglutamine proteins increased the mRNA level of Atg12 in a PERK-eIF2 $\alpha$ -dependent manner [147]. A potential interaction of PERK-Nrf2 signaling with ER stress-induced autophagy has also been postulated, though it is unclear whether Nrf2 is upstream or downstream of, or whether it stimulates or hampers, the autophagic signal [139]. Furthermore, there is little information regarding the regulation of proteasomal and autophagic ERAD in skeletal muscle.

#### *CHOP mediates ER stress-induced cell death*

Failure to resolve prolonged or severe ER stress can result in cell death, usually by activation of intrinsic apoptosis [148] mediated in part by CHOP. CHOP is a 29-kDa protein with an N-terminal transcriptional activation domain and a C-terminal bZIP domain, the latter of which is important for CHOP-mediated apoptosis [149]. CHOP was

first identified as a dominant-negative inhibitory binding partner of C/EBP-like proteins via formation of stable dimers that eliminates the ability of C/EBP proteins to bind to DNA enhancer elements in their target genes [150]. However, it was later discovered that CHOP-C/EBP heterodimers have the ability to bind to a unique DNA control element in specific genes, conferring to CHOP the ability to both inhibit and activate particular gene targets [149]. Owing to its C/EBP family identity, CHOP is also known as C/EBP $\zeta$  [149]. It is also called DNA damage-inducible transcript 3 (DDIT3) [149] and growth arrest- and DNA damage-inducible gene 153 (Gadd153) because it was initially thought to be induced by DNA damage and cell arrest [151], though it has been shown to be most sensitive to ER stress [152].

The basal expression of CHOP is very low [150], and its transcription is highly inducible in response to severe ER dysfunction [149]. Upregulation of CHOP is primarily mediated by PERK-eIF2 $\alpha$ -ATF4 signaling, as ATF4 deletion blocks induction of CHOP [133]. However, CHOP is a downstream effector of all three arms of the ER stress pathway, as there are binding sites for ATF4, ATF6, and XBP1s present within the CHOP promoter [4], and activation by all three pathways is required for full induction of CHOP [149]. Forced expression of CHOP alone does not cause cell death but instead sensitizes cells to ER stress [153]; however, deletion of CHOP protects against ER stress-induced cell death [149, 154]. One mechanism by which CHOP induces cell death is by eliminating translational inhibition, thus promoting protein synthesis in an already stressed cell [153]. This occurs by transcriptional activation of Gadd34, whose protein product is a phosphatase that removes the inhibitory phosphate from eIF2 $\alpha$  [154]. Furthermore, numerous *in vitro* and *in vivo* studies have demonstrated that CHOP is a

“master regulator” of ER stress-induced apoptosis [5]. Importantly, in skeletal muscle this does not result in death of the entire muscle cell or fiber; instead, ER stress cell death signals converge on the mitochondria and eventually lead to activation of caspase-3 [149].

In non-muscle cell types, overexpression of CHOP downregulates Bcl2 expression and induces Bax translocation to the mitochondria [142]. ER stress may also alter Bcl2 stability via phosphorylation, which, in most situations, reduces its antiapoptotic activity and/or increases its degradation [155]. CHOP also increases gene expression of pro-apoptotic BH3 only protein Bim, which is required for ER stress-induced apoptosis induced by thapsigargin in MCF-7 cells [156], while knockdown of CHOP prevents the induction of Bim by tunicamycin [157].

There is limited evidence of the association between ER stress and caspase-3 activation in muscle. CHOP deficient mice display attenuated cardiac caspase-3 activation and TUNEL-positive nuclei compared to wild type mice in response to pressure overload [158]. One study examining ageing-related signaling leading to apoptosis in skeletal muscle found that increased cleaved caspase-3 was associated with elevated CHOP and phosphorylated Bcl2 proteins in the soleus of aged (32 month) rats [159]. However, more studies are needed to fully elucidate the signaling downstream of CHOP. It is unknown whether the transcription factor directly or indirectly regulates Bcl2 family proteins or other mediators of apoptosis [149], especially in skeletal muscle.

Endoplasmic reticulum stress and UPR is activated in disease

Obesity a strong predisposing factor for many metabolic diseases and is linked to ER stress. For example, transgenic obese mice (*ob/ob*) and those made obese by high fat diet feeding for 16 weeks exhibit increased PERK activation, serine 51 phosphorylation of eIF2 $\alpha$ , and BiP protein expression in liver and adipose tissue [160]. Furthermore, ER stress has been implicated in the pathogenesis of numerous diseases, including cardiovascular disease, neurodegenerative diseases, cancer [4], nonalcoholic fatty liver disease (NAFLD), multiple inflammatory diseases [5], and various kidney pathologies [6]. It is also not surprising that ER stress is a major contributing factor to pancreatic  $\beta$ -cell apoptosis, given the highly secretory nature of the  $\beta$ -cell [7]. ER stress has also been linked to insulin resistance in liver and adipose tissue [5]. Both  $\beta$ -cell apoptosis and insulin resistance contribute to the development of T2DM.

ER stress has been extensively studied in pancreatic, liver, and adipose tissue, highly metabolic organs integrally involved in the pathogenesis of diabetes. However, despite the fact that skeletal muscle is critical for glucose uptake and other metabolic processes intimately related to pathogenesis of obesity and diabetes, there is a paucity of information on the relationship of ER stress and disease in this tissue [8]. Until recently, examination of ER stress in skeletal muscle has been limited to myotonic dystrophy Type I [161] and sporadic inclusion body myositis [162]. However, more recent studies suggest that ER stress may be an important factor in muscle atrophy. Microarray analysis of gene expression alterations in response to different atrophy stimuli revealed that ATF4 mRNA is highly induced in muscle due to diabetes and renal failure [70, 110]. Examination of



eIF2 $\alpha$ -ATF4 signaling using overexpression and knockout models indicates that this pathway required for fasting-induced myofiber atrophy [163].

## **FATTY ACIDS**

### *Fatty acid structure and nomenclature*

Several excellent reviews have described the biological roles, structures, and nomenclature of fatty acids [164, 165]. Fatty acids (FAs) are the simplest of lipid moieties and the fundamental building blocks of more structurally complicated lipids such as phospholipids, esters, glycolipids, and triglycerides. They are an important source of fuel, components of cell membranes (as glycolipids and phospholipids), and second messengers involved in numerous cell signaling responses. Their hydrophobic structure is comprised of a carboxylic acid “head” and a hydrocarbon “tail” of variable length. The carboxy end of the molecule is also identified as the “alpha” terminus, while the end of the hydrocarbon tail contains a methyl group and is also called the “omega” terminus. In addition to the length of the hydrocarbon chain, FAs can also differ in the presence, number, location, and orientation of double bonds between carbon atoms in the tail.

The hydrocarbon tails of saturated fatty acids (SFAs) contain no double bonds, while those with double bonds are classified as unsaturated. The number and orientation of double bonds further designates subclasses of unsaturated fatty acids (UFAs). Monounsaturated fatty acids (MUFAs) contain one carbon-carbon double bond, while polyunsaturated fatty acids (PUFAs) contain more than one carbon-carbon double bond. The location of two connected carbon atoms on the same side or opposite sides of the double bond designates the atom as fatty acid as *cis* or *trans*, respectively. Most

naturally-occurring fatty acids are *cis*. *Trans* fatty acids are typically produced by hydrogenation, a manufacturing process used to protect oils from oxidation and convert the naturally fluid structure to a more solid form at room temperature.

SFAs and UFAs are classified differently based on their chain length, i.e. number of carbon atoms in the hydrocarbon tail. SFAs are short chain (3-7 carbon atoms), medium chain (8-13 carbon atoms), long chain (14-20 carbon atoms), or very long chain (>21 carbon atoms). UFAs are short chain (<17 carbon atoms), long chain (18-24 carbon atoms), or very long chain (>25 carbon atoms). The hydrocarbon chains of most naturally-occurring FAs, especially long and very long chain, contain an even-number of carbon atoms.

MUFAs and PUFAs are further categorized based on the location of the double bond(s) within the hydrocarbon tail. Long-chain PUFAs with the first double bond at the third or sixth carbon from the omega end are called *omega-3* ( $\omega$ -3) or *omega-6* ( $\omega$ -6), respectively. Similarly, the long-chain MUFA oleic acid (OA) is considered *omega-9* ( $\omega$ -9) because its single double bond is at the ninth carbon from the methyl end.

The systematic name of FAs is issued by the International Union of Pure and Applied Chemists (IUPAC). This method numbers the carbon atoms from the carboxylic acid end, with each double bond identified by the lower number of the 2 carbons it joins. For example, the systematic name for docosahexaenoic acid (DHA), an  $\omega$ -3 PUFA with 22 carbons and 6 double bonds, is *cis-cis-cis-cis-cis-cis-4,7,10,13,16,19-docosahexaenoic acid*. Examples of the IUPAC names for the FA discussed in this chapter are shown in Table 2.1. Since the IUPAC designation is rather laborious, FA are often identified by a more common nomenclature using a short-hand “C:D (n minus)” system, where C and D

represents the number of carbons and the number of double bonds, respectively. The “n minus” portion designates the location of the first double bond from the methyl/omega end of the molecule; therefore, the “n” is often replaced by the “ $\omega$ ” symbol. For example, the trivial nomenclature for DHA is 22:6n-3 or 22:6 $\omega$ -3. Examples of the C:D (n minus) names for the FA discussed in this chapter are also included in **Table 2.2**. The relative abundance of these FA in the diet and body tissues is discussed in the following three sections.

### Synthesis of saturated and omega-3 polyunsaturated fatty acids

Mammals can synthesize SFAs and MUFAs *de novo* from acetyl CoA in the liver and lactating mammary glands; therefore, they are not considered essential nutrients. The primary product of *de novo* FA synthesis is palmitic acid (16:0), or palmitate, which can be further elongated and desaturated depending on the body’s needs [14]. On the other hand, humans lack the desaturase enzymes required to insert a double bond at the  $\omega$ -3 or  $\omega$ -6 positions [42] yet these PUFAs are required for normal growth and development; therefore, fatty acids with these pre-formed bonds are essential nutrients [166].

The two classical essential fatty acids in the human diet are  $\alpha$ -linolenic acid (ALA, 18:3n-3) and linoleic acid (LA, 18:2n-6) [167]. ALA and LA can be enzymatically converted to other  $\omega$ -3 and  $\omega$ -6 moieties through a series of elongation and desaturation reactions (**Fig. 2.6**). The other major  $\omega$ -3 PUFAs eicosapentaenoic acid (EPA, 20:5n-3) and DHA and the  $\omega$ -6 arachidonic acid (AA, 20:4n-6) can be generated from conversion of ALA or LA, respectively, or consumed directly from the diet [42]. Because EPA, DHA, and AA are also required for normal development and health, they are considered conditionally essential fatty acids [164].

**Table 2.1 Fatty acid nomenclature**

<b>Abbreviation</b>	<b>Common</b>	<b>C:D (n minus)</b>	<b>IUPAC (Systematic)</b>
PA	Palmitic Acid	16:0	hexadecanoic acid
OA	Oleic Acid	18:1n-9	cis-9-octadecenoic acid
LA	Linoleic Acid	18:2n-6	cis-cis-9,12-octadecadienoic acid
AA	Arachadonic Acid	18:4n-6	cis-cis-cis-cis-5,8,11,14-icosatetraenoic acid
ALA	$\alpha$ -Linolenic Acid	18:3n-3	cis-cis-cis-9,12,15-octadecatrienoic acid
EPA	Eicosapentaenoic Acid	20:5n-3	cis-cis-cis-cis-cis-5,8,11,14,17-icosapentaenoic acid
DHA	Docosahexaenoic Acid	22:6n-3	cis-cis-cis-cis-cis-cis-4,7,10,13,16,19-docosahexaenoic acid

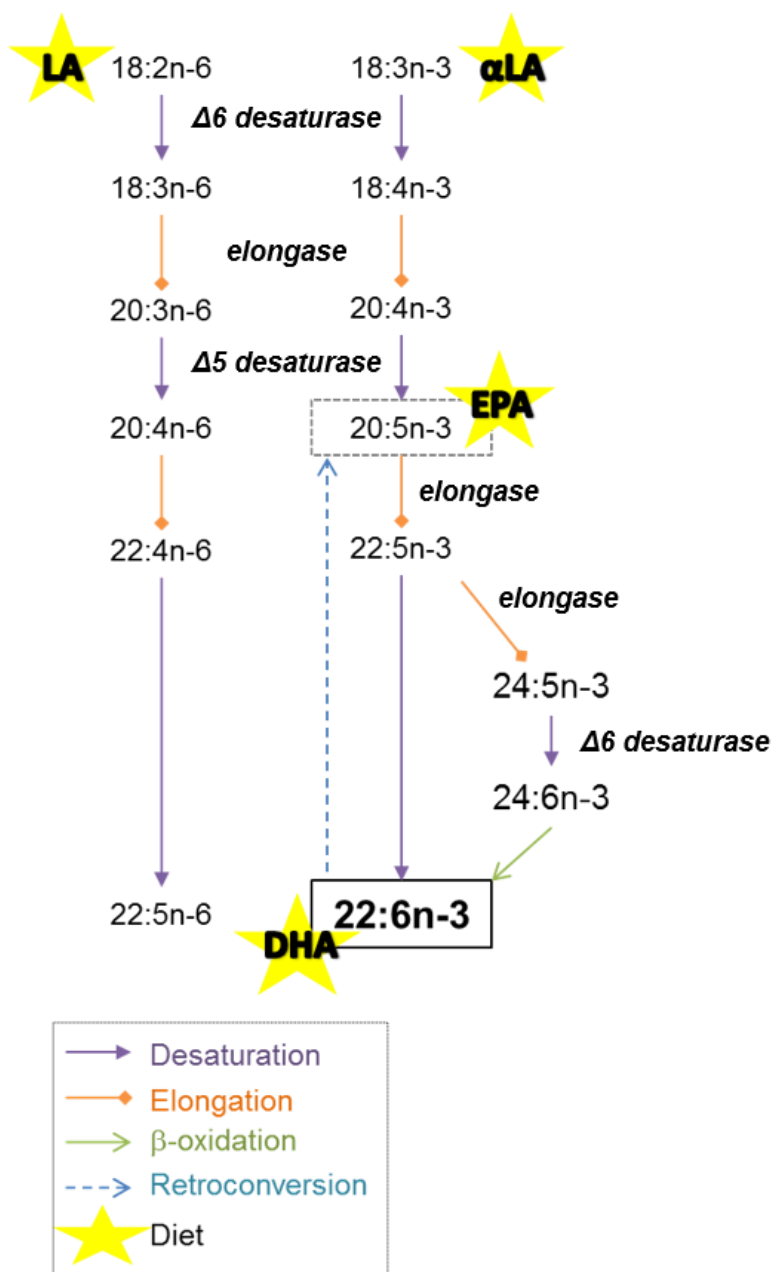

**Figure 2.6. Interconversion of omega-6 and omega-3 PUFAs.** Linoleic acid (LA) and  $\alpha$ -linolenic acid (ALA) are converted by a series of desaturation and elongation reactions to longer chain omega-6 and omega-3 PUFAs, respectively.

### Efficiency of omega-3 conversion in humans

Studies using stable isotopes demonstrate that the interconversion of ALA to EPA and DHA is very low in humans, though the measured efficiencies vary due to heterogeneity in study design and the lipid pools assessed. Overall, it is estimated that the conversion of ALA to EPA is <10% and the conversion of ALA to DHA is between 0%-4% [18]. The first and rate-limiting step in the conversion of ALA to its longer chain  $\omega$ -3 PUFAs is catalyzed by  $\Delta$ 6-desaturase, which also facilitates the first step in conversion of LA to its longer chain counterparts. While the enzyme has a higher affinity for ALA, high intakes of dietary  $\omega$ -6 PUFA have been proposed as a potential limiting factor for the conversion of ALA to EPA and DHA by competing for  $\Delta$ 6-desaturase [18].

Numerous studies demonstrate that increasing intake of ALA effectively raises EPA but not DHA in cellular membranes and lipids [18, 40-42]. In healthy adults, consumption of less than 1 g/day to over 18 g/day ALA for weeks to months results in an approximately linear increase in the EPA content of plasma, phospholipids, erythrocytes, and leukocytes, while DHA content remains unchanged and has been shown to decrease with high levels of ALA intake [18, 40]. There is evidence that supplementation with DHA can increase blood EPA levels through metabolic retroconversion, though different studies report a wide range of efficiency of the process from 1.4% [168] to 9-12% [169, 170] in humans.

As one would expect, vegans and vegetarians have lower serum and platelet DHA levels than omnivores [171]. DHA supplementation has been shown to effectively increase the proportion of DHA in the non-esterified FA and phospholipid pool in serum [42, 43] and other tissues [41, 44]. Together these studies demonstrate that the most

efficient method for increasing DHA status is by consumption of pre-formed DHA.

Lastly, palmitate is the most abundant SFA in serum non-esterified FAs and cholesterol esters [43, 172], and the molar percentage of circulating palmitate is between 3-11 times higher than that of DHA in human serum after 6 weeks of DHA supplementation [43].

#### *Dietary consumption of saturated and omega-3 fatty acids*

Rich food sources of SFAs are primarily animal-based products including whole milk, cream, butter, cheese, and fatty meats, but the plant-based palm, palm kernel, and coconut oils also contain high levels of SFAs. The National Academy of Sciences Institute of Medicine (IOM) recommends that total fat intake by adults range between 20-35% of total daily kilocalorie intake and that SFA intake be kept as low as possible and comprise no more than 10% of fat calories. The IOM has not established an estimated average requirement or recommended dietary allowance for SFA because they are not essential and have no known role in preventing chronic disease [173]. Data from NHANES III and the US Department of Agriculture indicate that the average intake of SFA in the general population is between 12-15% of total calorie intake [14].

Rich dietary sources of ALA include ground flaxseed, walnuts, perilla, and plant oils including rapeseed, soybean, and canola [18, 164, 174]. American men and women consume approximately 1.5 and 1.0 g/day ALA, respectively, which is slightly below the 2002 IOM-established adequate intake of 0.6% of total energy intake (1.6g/day for men consuming 2,400 kcal and 1.1g/day for women consuming 1,700 kcal) [15]. However, a more recent review by Wijendran et al. [15] recommends that a slightly higher ALA intake of 0.75% of total kilocalories (1.7 g/day per 2,000 kilocalories) confers the most

cardiovascular protection. This value is within the acceptable macronutrient distribution range of 0.6-1.2% of total calorie intake set by the IOM for ALA [173].

The richest dietary source of EPA and DHA is oily fish or fish oil supplements [18]. Specifically, fish/seafood with >500 mg/3-ounce serving include anchovy, mackerel, pompano, salmon, sardines, sea bass, swordfish, trout, and white (albacore) tuna. Sources with lower amounts (<500 mg/3-ounce serving) include carp, catfish, clams, conchs, cod, croaker, flounder, frogs, haddock, halibut, lobster, mullet, octopus, squid, oysters, perch, pike, pollock, porgy, scallops, shrimp, snapper, whiting, and other non-albacore species of tuna [175]. DHA, but not EPA, can also be provided by cold water algae [170], though this source likely contributes more in supplement form than as a whole food in the diet.

Most dietary DHA and EPA is consumed by Americans in the form of fish or seafood [174] which are also rich in high quality protein and micronutrients such as selenium and low in SFA. The median intake of seafood in the US is approximately 3.5 ounces per week [172] for a typical dietary intake of about 0.1-0.15 grams/day of EPA+DHA [174]. The top ten varieties of seafood consumed in the greatest quantities by Americans are shrimp, canned tuna, salmon, pollock, catfish, tilapia, crab, cod, clams, and flatfish. Upon close examination of this list, it becomes apparent that the types of seafood most often consumed by Americans are not the richest sources of EPA and DHA. The most recent report indicates that only 20% of the seafood consumed contains high levels of EPA and DHA. Interestingly, due to the large consumption of eggs and chicken, these foods may also contribute a significant amount of EPA and DHA to the American diet, though they are not particularly rich sources of these PUFAs [175].



While there is no adequate intake for EPA and DHA, Wijendran et al. [15] recommend that Americans aim to increase EPA and DHA to 0.25%-0.5% of total energy intake (0.5-1.1 g/day per 2,000 kcal) at the expense of SFA and MUFA for optimal cardiovascular protection. This level can be achieved by consuming fish 2.5-3 times per week for an average daily intake of approximately 500 mg EPA+DHA [174]. The optimal intake of  $\omega$ -3 PUFA for other physiological outcomes has not been studied.

#### *Relationship of palmitate and omega-3 fatty acids and cardiovascular health*

The majority of research on dietary fatty acids has focused primarily on their role in lipoprotein metabolism and related cardiovascular outcomes. Epidemiological and clinical studies point to large amounts of SFAs as harmful to overall health [14]. It is generally recognized that SFAs cause an unfavorable increase in blood cholesterol, though the specific mechanisms underlying these effects is still not entirely clear. Increasing SFA to 19-30% of total energy intake leads to increased total cholesterol and LDL cholesterol levels in adults [15]. Furthermore, higher serum levels of 14:0, 16:0, and 18:0 phospholipid FAs are associated with an increased incidence of coronary heart disease [16].

Conversely, numerous prospective cohort studies and randomized controlled trials support an inverse relationship between the dietary intake of EPA and DHA and risk factors for cardiovascular disease [18, 19]. The suggestion that these PUFAs appear to be the most important  $\omega$ -3 influencing cardiovascular health [18] is supported by the results from primary and secondary prevention studies which show that EPA and DHA but not ALA improve cardiovascular disease outcomes [17] and studies indicating that long-term

consumption of 2-3 servings of fatty fish per week is associated with reduced rates of primary and secondary myocardial infarction and cardiovascular disease death [174]. Furthermore, a recent study reviewing meta-analyses of prospective cohort studies and randomized controlled trials indicated that omega-3 PUFA supplementation reduces the risk of fatal coronary heart disease by 10% as well as reduces markers of ventricular fibrillation, inflammation, endothelial dysfunction, and platelet aggregation [176]. Other studies indicate that 400-1000 mg/d EPA+DHA reduces the risk of CHD, and EPA and DHA have also been shown to help lower blood pressure, platelet sensitivity, and serum triglyceride levels [15].

*Potential cellular mechanisms underlying the differential effects of saturated and unsaturated fatty acids*

Numerous studies report that SFA and UFA exert differential physiologic and metabolic effects. High doses of SFA generally promote unfavorable consequences in muscle tissue, while high levels UFA are typically benign or result in positive alterations in cellular processes. Given the important roles of fatty acids in myriad cellular functions, multiple mechanisms likely contribute to this discrepancy. These may include but are not limited to differential incorporation of SFA and UFA into membrane and/or intracellular lipid pools, contrasting effects on mitochondrial function, and varying rates of oxidation of UFA and SFA species.

The incorporation of UFA and SFA moieties into membrane phospholipids varies and differentially alters the properties of the membrane. An *in vitro* study examining the phase behavior of hydrated phospholipid bilayer demonstrated that the incorporation of

PA and other SFA into the bilayer decreases the phase transition temperature and increases the gel phase bilayer rigidity (i.e. reduces the fluidity of the membrane), while incorporation of OA does not appreciably alter membrane fluidity [177]. Interestingly, DHA has been shown to rapidly and preferentially incorporate into plasma and mitochondrial membrane phospholipids and alter their properties, resulting in changes to the local structure and function of cell membranes including an increase in membrane fluidity [178, 179]. A PUFA-mediated improvement in cell membrane fluidity and microdomain organization may facilitate membrane-associated cell signaling processes. Indeed, in rodents, dietary supplementation with fish oil promotes incorporation of long-chain  $\omega$ -3 PUFA in skeletal muscle phospholipids, an effect that is highly positively correlated with insulin action [20]. There is a similarly strong correlation between insulin sensitivity and the total PUFA content and unsaturation of skeletal muscle phospholipids in human adults [12]. Indirect evidence suggests that increasing the PUFA content of skeletal muscle phospholipids improves protein metabolism. Supplementing the formula of weaning piglets with long-chain  $\omega$ -3 PUFA promotes their incorporation in muscle phospholipids and retards the developmental decline in insulin sensitivity, resulting in a reduction in the whole-body oxidative loss of amino acids and an increase in muscle protein accretion [180]. Additionally, transgenic *fat-1* mice with high endogenous omega-3 PUFA in muscle phospholipids better maintain their muscle mass after sciatic nerve injury compared to wild type mice [38].

The UFA- and SFA-mediated alterations in membrane structure may also have important effects on mitochondrial function and associated cell signaling events. Mitochondria are involved in a variety of cellular processes, and mitochondrial

dysfunction or damage, particularly the chronic production of mitochondrial-generated reactive oxygen species, has been linked to the pathogenesis of numerous muscle, neurodegenerative, and chronic diseases [181]. In human skeletal muscle primary myotubes, treatment with SFA reduces mitochondrial activity while UFA increases it [182]. Similarly, incubation of C2C12 myotubes for 24h with SFA (PA and stearate) but not UFA (OA, LA, EPA, and DHA) causes mitochondrial dysfunction characterized by decreased mitochondrial hyperpolarization and ATP generation [183]. Moreover, treatment with PA, but not OA, increases the generation of mitochondrial reactive oxygen species and mitochondrial DNA damage which is linked to reduced insulin signaling; co-treatment of OA and PA abolishes the effects of SFA on mitochondria [184].

Importantly, dietary FA can directly alter mitochondrial phospholipid composition and dynamics [185]. In a recent review article, Monteiro et al. [186] argue that modulation of mitochondrial membrane lipid composition plays an important role in both normal and pathophysiological processes. Furthermore, they propose that manipulation of dietary FA is a plausible strategy for altering mitochondrial membrane phospholipid content and function by 1) providing precursors for lipid synthesis (i.e. direct regulation), 2) altering the activity of enzymes involved in lipid synthesis and the membrane lipid environment (i.e. indirect regulation), and 3) changing the expression or regulation of mitochondrial proteins (i.e. genetic regulation). Future studies in the emerging field of mitochondrial lipidomics will offer insight into the role of dietary lipids, and particularly the differential effects of SFA and UFA, on skeletal muscle mitochondrial function and protein balance.

Lastly, studies suggest that differential accumulation and oxidation of UFA and SFA in muscle cells results in disparate cellular outcomes. The preponderance of evidence

indicates that SFA tend to generate and accumulate as bioactive lipid molecules (e.g. diacylglycerol, ceramides) [35, 187-190] which, among other consequences, can activate pathways that impair insulin signaling or promote apoptosis [36, 187, 189]. Interestingly, pre- or co-incubation of UFA with SFA has been shown to divert the accumulation of SFA toward neutral lipid pools (i.e. triacylglycerols) [35, 36, 187] and prevent the detrimental effects of SFA [36, 187-189]. In addition to accumulating neutral lipids, UFA may reduce the pool of bioactive lipids by increasing the rate of lipid oxidation. The oxidation rate of SFA decreases as the chain length increases and is generally slower than the oxidation of UFA [191]. Pre- or co-incubation of SFA with UFA increases the oxidation rate of PA [187], a response that is at least partially due to an UFA-induced increase in transcriptional regulation of enzymes involved in lipid oxidation [188]. In healthy adults, a large dose of fish oil (6g/d) increases basal lipid oxidation and the basal metabolic rate [192], suggesting that the  $\omega$ -3 are either effectively oxidized or promote the oxidation of stored lipids [193].

## **LIPIDS AND SKELETAL MUSCLE**

### *Dietary lipids affect skeletal muscle lipids*

Consumption of a high fat diet for as little as 24 hours and up to 7 weeks increases the intramyocellular triglyceride content of human skeletal muscle by 36%-90% [24]. Similar to the alterations in serum phospholipids and circulating NEFA, skeletal muscle lipids also reflect dietary lipid intake [22-24]. In one study, healthy adults consumed isocaloric diets containing either 18% SFA or 19% MUFA for 3 months, with or without a fish oil supplement that provided 2.4 g/d of EPA+DHA. The SFA diet increased the percentage

of palmitate in muscle triacylglycerols compared to the MUFA diet, and fish oil supplementation increased the percentage of DHA in muscle phospholipids and triacylglycerols, regardless of diet type. However, the effects of the dietary FA on total IMTG content was not assessed [22]. In rodents, the fatty acid profile of muscle triacylglycerols and diacylglycerols also reflected dietary FA intake, and, interestingly, the total myocellular lipid content of animals fed a high PUFA was similar to that of those fed a low-fat diet indicating that the PUFAs prevented muscle lipid accumulation [24].

#### *Lipids and skeletal muscle insulin resistance*

Skeletal muscle insulin resistance is associated with systemic perturbations in lipid metabolism. Adipose tissue lipolysis is very sensitive to the antilipolytic effects of insulin. The concentration of insulin that produces 50% of the maximal inhibitory effect (i.e. EC<sub>50</sub>) is increased 2-3-fold in obese subjects and those with T2DM [10]. Resistance to the antilipolytic effect of insulin contributes to high levels of circulating NEFA observed in these conditions [10, 59, 194, 195].

High NEFA have been shown to directly affect skeletal muscle insulin sensitivity. In healthy individuals and subjects with T2DM, insulin-stimulated glucose uptake (ISGU) is inhibited in a dose-dependent manner by increasing circulating NEFA throughout a physiological range [194]. Lowering of NEFA levels reduces insulin resistance and improves glucose tolerance in obese individuals with and without T2DM [195]. NEFA transport into skeletal muscle is increased by high fat feeding in healthy rats [196] as well as in obese Zucker rats [197] and obese and diabetic humans [198]. This increase in lipid

flux contributes to the accumulation of intramuscular lipids [198-202]. Mean muscle triglyceride accumulation is inversely correlated with skeletal muscle insulin sensitivity in rats [20] and in humans with and without obesity and T2DM [51-53].

*Saturated fatty acids are associated with decreased insulin sensitivity*

A recent study using 2-dimensional localized correlated spectroscopy demonstrated that the soleus muscle of adults with well-controlled T2DM contains more intramyocellular and extramyocellular lipids that are comprised of a lower relative amount of MUFA and PUFA (i.e. a higher level of SFA) than the same muscle of healthy controls [203]. This suggests that SFA may have more of a detrimental effect on muscle than UFAs. Treating muscle cells with palmitate, but not the UFAs oleate or LA, suppresses ISGU in muscle cells. This effect is associated with the incorporation of the SFA into and accumulation of diacylglycerols in the cells, which is not observed with the UFAs [35, 36]. Furthermore, skeletal muscle of obese patients contains a greater percentage of SFA than that of lean controls, and insulin resistance directly correlates with the SFA content in skeletal muscle lipids [53].

*Omega-3 PUFA are associated with improved insulin sensitivity*

The first evidence that  $\omega$ -3 fatty acids may protect cells from defects in insulin signaling was reported by Storlien and colleagues in 1987 [21]. They demonstrated that replacing 6% of  $\omega$ -6 PUFA with  $\omega$ -3 PUFA from fish oil prevented high fat-induced insulin resistance in rats. A few years later, they showed that insulin action correlated highly with the percentage of long-chain  $\omega$ -3 fatty acid in muscle phospholipids [20].

Subsequent studies over the following 25 years further demonstrated that supplementation of a small amount of long chain  $\omega$ -3 PUFA for other FA attenuates reductions in insulin sensitivity caused by oversupply of lipids in muscle cells [32, 204] and in metabolically healthy [26, 27] and obese and insulin resistant animals [28-30]. The cell studies used either EPA or DHA alone, while all of the animal studies used fish oil, which is highly enriched in both EPA and DHA. Furthermore, one study demonstrated that fasting glucose and HOMA index are substantially reduced by dietary supplementation with EPA and/or DHA as compared to ALA in healthy rats [31]. Together these studies indicate that the longer chain omega-3 PUFAs EPA and DHA offer beneficial effects for insulin sensitivity in animals.

It has been suggested that the positive metabolic effects of  $\omega$ -3 PUFAs are linked to their ability to prevent weight gain [193]. However, in the initial study by Storlien et al. [21], the high fat-fed rats whose diets contained replacement of some  $\omega$ -6 with  $\omega$ -3 did not have decreased body weights compared to the rats on the high  $\omega$ -6 PUFA diet, and both high fat diets led to increased body weight compared to mice fed standard chow. Another study in which rats were fed a diet high in  $\omega$ -6 or  $\omega$ -3 PUFAs found that rats on both high fat diets had a similar and significant increase in body weight compared to rats fed a chow diet, though the  $\omega$ -3 diet prevented the defect in insulin receptor signaling in muscle that was observed in the  $\omega$ -6-fed animals [23]. To determine whether the  $\omega$ -3 PUFAs or a lack of weight gain is responsible for protecting mice from high fat diet-induced insulin resistance, one group used a transgenic mouse model expressing the *fat-1*  $\omega$ -3 fatty acid desaturase from *C. elegans*, which efficiently converts endogenous  $\omega$ -6 to  $\omega$ -3 PUFAs. While both groups of animals had similar weight gain in response to the



high fat diet, the wild type animals displayed a reduced ratio of EPA and DHA to LA in skeletal muscle membranes and became insulin resistant while the *fat-1* mice did not [205]. Moreover, another study using the same transgenic animals also demonstrated that the  $\omega$ -6: $\omega$ -3 ratio in muscle phospholipids was reduced by around 20-fold and whole-body glucose tolerance was significantly improved in *fat-1* compared to wild type mice. This was independent of weight gain and diet, as body weight was not different between groups and all animals were fed a more standard chow containing 15.8% fat (high omega-6), 63.9% carbohydrate, and 20.3% protein [206]. These results indicate that the effects of  $\omega$ -3 PUFAs on insulin sensitivity are not dependent on prevention of body weight gain.

Studies of the effects of  $\omega$ -3 PUFAs on insulin sensitivity and glucose control in humans have mixed results. One study found a positive association between the degree of unsaturation of muscle phospholipids and insulin sensitivity in both healthy men and those undergoing coronary artery surgery [12], and another study showed that plasma phospholipid EPA and DHA is negatively associated with HOMA-IR index in adults with T2DM [11]. Furthermore, a small study of  $\omega$ -3 supplementation in patients with T2DM (n=6) indicates that 3 g/d EPA+DHA for 8 weeks improved *in vivo* ISGU [13].

On the other hand, another randomized-controlled study in patients with T2DM and hypertriglyceridemia reported no alterations in insulin sensitivity after supplementation with EPA+DHA for 6 months (2.7 g/d EPA+DHA for 2 months followed by 1.7 g/d EPA+DHA for 4 more months) [207]. Furthermore, a meta-analysis of intervention studies in patients with type 1 and type 2 DM found that fish oil supplementation significantly decreased fasting blood glucose in patients with type 1 diabetes but tended

to increase fasting blood glucose in patients with T2DM [208]. Other earlier studies that also showed negative effects of fish oil on glycemic control, but these studies used very large doses of fish oil (5.5-8 g/day omega-3 PUFA) and lacked appropriate control groups [209]. Overall, there is no clear adverse effect and possible beneficial effects of EPA and DHA on insulin sensitivity in humans.

### *Lipids and ER stress*

#### *High-fat diet and palmitate induce ER stress in non-muscle tissues*

Both high fat diet and the SFA palmitate have been shown to elicit ER stress in different cell types/tissues. The particularly detrimental effects of SFAs in the development and progression of non-alcoholic liver disease and pancreatic  $\beta$ -cell apoptosis appear to be related at least in part to their strong induction of ER stress. In cultured human liver cells, palmitate increased the protein level of PERK, ATF4, and CHOP and induced apoptosis, while knockdown of PERK antagonized the response [210]. In rats, hepatic steatosis induced by a diet containing high levels of SFAs is accompanied by increased markers of ER stress (XBP1s mRNA, BiP and CHOP protein), activation of caspase-3, and liver injury. However, the upregulation of ER stress markers and caspase-3 activity was not observed in rats fed a diet high in PUFAs [211]. Furthermore, palmitate, but not the MUFA oleate, increases ATF4 and CHOP mRNA expression and apoptosis in insulin-secreting cultured MIN4 cells [7].

*High-fat diet and palmitate induce ER stress in skeletal muscle*

Recently, Deldicque and colleagues [34] examined the effects of high fat diet on ER stress in mouse skeletal muscle using two separate feeding protocols. Specifically, mice fed 70% fat and <1% carbohydrate for 6 weeks had increased ER stress markers (IRE1 $\alpha$  and BiP proteins and ATF4 mRNA) in the tibialis anterior and soleus muscles. A more physiologically-relevant diet of 46% fat and 36% carbohydrate for 20 weeks also increased phospho-PERK protein and ATF4, CHOP, and XBP1s mRNA in the plantar flexors compared to mice fed standard chow. The authors did not state the relative percentages of the saturated and mono/unsaturated fatty acids provided by the combination of lard and either soybean oil or corn oil in the two high fat diets, making it difficult to assess whether the saturated fat content of the high fat diets may be to blame for the unfavorable effects in the muscle tissue.

However, the authors did replicate the UPR results by treating cultured C2C12 myotubes with palmitate for 17 hours, and in this *in vitro* study they additionally showed that palmitate suppressed protein synthesis by 20% [34]. In a subsequent study, the same group examined whether the defect in protein synthesis may be due to ER stress and found that thapsigargin and tunicamycin induced anabolic resistance in muscle cells, characterized by impaired basal and leucine-stimulated phosphorylation of Akt and S6K1 [212]. Although phosphorylation of these proteins in response to insulin was not impaired by the ER stress inducers, the basal suppression of the Akt pathway by the ER stressors is suggestive of a potential relationship between ER stress and insulin resistance that may promote loss of skeletal muscle mass. While this particular study did not examine the

effects of palmitate-induced ER stress on insulin resistance, other reports have suggested that palmitate-induced ER stress may contribute to the development of insulin resistance.

In a series of studies, Yuzefovych and colleagues [184, 213, 214] present evidence suggesting that palmitate induces mitochondrial DNA damage, causing over-production of reactive oxygen species which leads to ER stress, autophagy, and apoptosis in L6 myotubes. Importantly, the MUFA oleate did not have similar effects. Additionally use of the ROS scavenger *N*-acetylcysteine and mitochondrial targeting of the DNA repair enzyme human 8-oxoguanine DNA glycosylase/(apurinic/aprimidinic) lyase each prevented the detrimental effects of palmitate, signifying that the prevention of oxidative damage to mitochondrial DNA is paramount to inhibiting the detrimental effects of palmitate in muscle cells.

Palmitate has been linked to mitochondrial instability in other studies. Treatment of C2C12 myotubes with 0.75mM palmitate for 16 hours increases Bax and decreases Bcl2 protein and increases the binding of Bax to Bcl2. This results in mitochondrial cytochrome *c* release and subsequent activation of caspase-3. The changes in mitochondrial mediators are associated with a reduction in Akt activation [215]; however, the authors did not assess ER stress markers or whether the reduction in Akt activation preceded the mitochondrial alterations. In a different study, cultured neonatal mouse cardiomyocytes treated for 24 hours with 0.1mM palmitate exhibited an increase in oxidative stress, activation of caspase-3 and apoptosis which was associated with a decrease in Bcl2 protein, while overexpression of Bcl2 prevented the induction of apoptosis by palmitate [216].

Considering that CHOP downregulates Bcl2 expression and that repletion of Bcl2 in CHOP-overexpressing cells protects against the depletion of cellular glutathione and prevents cell death [142], coupled with the fact that the Bcl2 family members can also be regulated by insulin signaling [89], it is feasible that the effects of palmitate on the mitochondria are mediated by both ER stress and insulin signaling pathways. It is also likely that palmitate induces oxidative stress, either as a proximal event, as suggested by Yuzefovych and colleagues, or as a result of the depletion of glutathione due to downregulation of Bcl2. Since a temporal relationship of these pathways has not been established, more studies are needed to clarify the nature of the association in skeletal muscle. Nevertheless, these data demonstrate that high levels of saturated fatty acids induce ER stress in skeletal muscle and suggest that unsaturated fatty acids may not have similar adverse effects.

#### *Omega-3 PUFA and ER stress*

There are little data regarding the effects of omega-3 fatty acids on ER stress, though the few available studies suggest that these fatty acids may offer protection in the brain. Begum and colleagues [217-219] demonstrated that DHA effectively prevents the PERK-eIF2 $\alpha$ -mediated upregulation of ATF4 and CHOP mRNA due to ischemia reperfusion injury in cultured astrocytes. A follow-up study revealed that intraperitoneal injection of DHA for 3-21 days following traumatic brain injury in rats attenuated expression of all ER stress marker proteins and promoted earlier recovery of sensorimotor function. Another group showed that dietary supplementation of EPA and DHA prior to and during a global ischemia reperfusion protocol in rats maintained hippocampal neuron survival

via increased Bcl2 and decreased Bax proteins [220]. To date, it remains unclear whether DHA could have similar effects on the ER in other tissues. There is a positive association between the DHA content and SR/mitochondrial volume density in skeletal muscle [44], and supplementation with DHA, but not EPA, effectively increases the DHA-containing phospholipid content of mitochondrial membranes and promotes mitochondrial stability in both normal and hypertrophied myocardium [221]. Therefore, DHA may confer a protective effect against stress-induced apoptosis in muscle cells.

### *Lipids and muscle atrophy*

Despite the plethora of research examining the effects of lipids on insulin signaling and ER stress pathways, few studies have assessed the effects of high lipid levels on protein metabolism in skeletal muscle. Given the integral roles for insulin-PI3K-Akt and ER stress signaling pathways in regulating both protein synthesis and protein degradation and the differential effects of SFAs and UFAs on these pathways, it is plausible that FAs can influence protein metabolism and may promote or prevent muscle atrophy.

Several studies suggest a relationship between dietary or skeletal muscle lipids and muscle mass. A recent analysis of a subset of participants from the Twins-UK study reported that fat-free mass is positively associated with the ratio of dietary PUFA:SFA and is negatively associated with percentage of dietary fat, SFA, MUFA, and *trans* FA intake [222]. These studies suggest that diets high in total fat and SFAs may cause alterations in protein metabolism in muscle that result in decreasing muscle mass. Furthermore, skeletal muscle lipid content is increased in disuse atrophy caused by stroke [223] and spinal cord injury [224]; however, the relationship of lipids to muscle atrophy

in these studies is masked by the known atrophy-inducing effect of muscle disuse. There is evidence that a high fat diet prevents muscle hypertrophy in response to functional overload, which is associated with decreased protein translation and suppressed Akt activation [225]. While this suggests that high levels of lipids are detrimental to a growth response, it does not address whether the lipids also cause a basal increase in protein degradation which would further impair muscle protein balance. The suppression of Akt activation and decrease in protein translation would suggest that proteolytic and ER stress pathways, respectively, may also be increased.

#### *Saturated fatty acids and muscle atrophy*

*In vitro* studies using cultured muscle cells suggest that oversupply of SFAs stimulates proteolytic pathways that may result in muscle atrophy. Numerous studies report that treatment of cultured myotubes with 100  $\mu$ M to 1 mM palmitate for 16-96 hours results in suppression of basal and/or insulin-stimulated Akt phosphorylation [183, 184, 204, 215, 226, 227]. This relieves the inhibition of FoxO3 [214], resulting in an increase in the mRNA expression of several atrophy-inducing genes, including MuRF1 and atrogin-1 [228, 229] and the protein level of Bnip3 and lipidated LC3 [214]. Other studies have shown that palmitate induces caspase-3 cleavage [184, 215], at least in part through alteration of mitochondrial stability. Palmitate increases the level of proapoptotic protein Bax and decreases the level of antiapoptotic Bcl-2, increases binding of Bax to Bcl-2, and induces mitochondrial release of cytochrome *c* and activation of caspases-9 and -3 in C2C12 myotubes [215]. Treating L6 myotubes with palmitate also results in release of cytochrome *c* and cleavage of caspase-3, which the authors attribute to the mitochondrial

DNA damage induced by the SFA [230]. Both Akt and ER stress pathways are known to regulate members of the Bcl2 superfamily that influence mitochondrial function and contribute to caspase-3-mediated myofiber cleavage [89, 159, 231]. Lastly, a high dose of palmitate has been shown to induce the conversion of LC3-I to LC3-II in myoblasts [232], and palmitate induces lipidation of LC3 and increases Bnip3 protein in myotubes [214]. Together these studies indicate that palmitate may induce proteolytic signaling through multiple pathways in cultured myotubes.

Three studies have examined the effects of high fat or high energy diets on skeletal muscle mass in animals. A high fat diet (43% of energy, 1.2:1 molar ratio of SFA:MUFA) for 24 months increased body weight and quadriceps lipid content and decreased cross-sectional area of the quadriceps muscle compared to rats fed a lower fat (25% of energy) isocaloric diet [233]. In another study, skeletal muscle mass was negatively correlated with body mass index in mice fed a high fat diet (35.8% of energy) for 5 months. The high fat diet increased the rate of protein degradation in muscle tissue, which was associated with a decrease in Akt phosphorylation and an increase in FoxO-mediated MuRF1 and atrogin-1 gene expression [228]. Lastly, a “Western-style” diet containing 65% carbohydrate, 19% protein, and 16% fat was compared to a control diet of 60% carbohydrates, 30% protein, and 10% fat for 16 weeks [234]. While the experimental diet was not a typical high fat model, it was designed to induce hyperphagia and weight gain [235]. The rats on the Western-style diet consumed approximately 50% more calories per day, which resulted in significantly higher body weight gain and development of hyperinsulinemia and dyslipidemia (high triglycerides and NEFA). The diet caused a reduction in quadriceps muscle fiber cross-sectional area by approximately



23%, which was associated with reduced PI3K-Akt inhibition of FoxO, increased MuRF1 protein and a trend toward increasing atrogin-1 protein, and activation of caspase-3 [234]. These studies support the observations that a diet high in total and saturated fat and increased muscle lipids are associated with decreased muscle mass in humans and further identify that regulation of protein degradation through Akt signaling is important for the lipid-induced alterations in muscle mass.

#### *Omega-3 PUFA and muscle atrophy*

Considering the generally positive relationship between omega-3 PUFAs and insulin sensitivity and the important role of the insulin signaling pathway in regulation of protein metabolism, omega-3 PUFAs may also influence protein balance in skeletal muscle. Inclusion of a fish oil-enriched nutritional supplement containing 2.4 g/d EPA + 0.96 g/d DHA in the diets of patients with pancreatic cancer resulted in gain of body weight and lean body mass after 3 and 7 weeks [39]. While this is suggestive of a protective effect of omega-3 PUFAs on muscle mass, the study did not include an energy- and protein-matched non-omega-3-containing supplement to determine if the alterations in body and lean mass were due the significant increase in daily total energy and protein intake. The observation that *fat-1* mice have increased muscle wet weight and fiber cross-sectional area after sciatic nerve injury than wild-type mice [38] also suggests that increasing the  $\omega$ -3 PUFA content of muscle lipids may attenuate muscle loss during atrophy-inducing conditions. To this end, the loss of soleus mass and myosin heavy chain protein was attenuated in rats who consumed a diet rich in fish oil prior to and during hindlimb immobilization (a model of disuse atrophy) compared to those who consumed corn oil.

The protection in muscle mass was associated with improved activation of Akt and p70S6K and attenuated expression of MuRF1 and atrogin-1 mRNAs [37]. MuRF1 and atrogin-1 mRNAs and plasma urea nitrogen were also reduced by fish oil supplementation in response to endotoxemia (a model of inflammation-induced atrophy) in weaning piglets, suggesting that the  $\omega$ -3 supplement induced cellular alterations that resulted in an inhibition of protein degradation [25].

Most studies of the metabolic effects of  $\omega$ -3 PUFAs have used fish oil, which is highly enriched in both EPA and DHA. Several studies have examined the effects of isolated EPA in various animal models of muscle wasting, and in general, they suggest that EPA effectively prevents atrophy induced by inflammatory and cancer-related conditions, such as sepsis, arthritis, tumors, and chemotherapy. In patients with nonsmall cell lung carcinoma, loss of skeletal muscle mass is inversely related to the plasma concentration of EPA and DHA [236], and supplementation with EPA prevents loss of skeletal muscle mass due to chemotherapy in these patients [237]. To date, investigation of the mechanism(s) by which EPA prevents muscle loss during atrophy-inducing conditions has been limited to atrophy models in cultured cells and animals. In cultured C2C12 myotubes, protein degradation was attenuated in cells treated with EPA compared to control, with no provision of an atrophy stimulus [238]. Supplementation with EPA attenuated the loss of gastrocnemius weight and the increase in MuRF1 and atrogin-1 mRNAs in arthritic rats [239], suggesting an inhibitory effect on proteasomal proteolysis. EPA supplementation also abolished the increase in protein degradation in skeletal muscle of septic mice [240] and cachectic tumor-bearing mice [241, 242] by counteracting the increase in expression of 20S proteasome subunits and reducing

functional proteasome activity [240, 241]. Notably, the protective effect of EPA in tumor-bearing mice was limited to inhibition of protein degradation, as no alterations in protein synthesis were observed with the  $\omega$ -3 PUFA [243]. Proteasome- and caspase-mediated proteolysis are also at least partially responsible for the initiation of protein catabolism in skeletal muscle by tumor-derived proteolysis-inducing factor (PIF).

Treating myotubes with EPA attenuates the PIF-induced increase in Bax protein, release of cytochrome *c*, and activation of caspase-3 [244]. The inhibition of proteasomal proteolysis by EPA has also been noted in a non-inflammatory atrophy model. Pre-treatment with EPA inhibited the starvation-induced increase in protein degradation by preventing upregulation of proteasome activity and subunit expression in skeletal muscle of mice [245]. Together these data demonstrate that EPA exerts an inhibitory effect on proteasomal proteolysis and attenuates muscle atrophy due to various stimuli.

It is difficult to draw generalized conclusions about the anti-atrophy potential of DHA because few studies have directly evaluated the effects of isolated DHA on pathways that regulate protein metabolism in skeletal muscle. One study in C2C12 myotubes found that treatment with 50  $\mu$ M DHA does not reduce protein degradation compared to control treatment [238]. Since no atrophy stimulus was administered to the cells, the study did not determine whether DHA can confer protection in the face of a cellular stressor. Finlin et al. [229] co-cultured human myotubes with either macrophages or fibroblasts and treated the cells for 24 hours with 200  $\mu$ M DHA, OA, or palmitate. Palmitate increased the protein level of Fn14, the TNF-like weak inducer of apoptosis receptor, in myotubes co-cultured with macrophages, whereas DHA reduced Fn14 protein. As Fn14 regulates MuRF1 in denervation-induced atrophy [246], an increase in Fn14 protein would be

expected to increase MuRF1 mRNA; however, no alteration in MuRF1 was observed due to macrophage co-culture or FA treatment. As expected, palmitate increased the level of atrogin-1 mRNA. Both palmitate and DHA reduced the phospho:total Akt ratio in myotube-fibroblast co-cultures [229], a surprising result given that palmitate and DHA have disparate effects on insulin sensitivity in muscle tissue, and omega-3 PUFAs tend to exert either a beneficial effect or no effect on muscle metabolism. While it is unclear why DHA had a negative effect on Akt activation, it was able to reduce the macrophage-stimulated increase in other atrophy markers.

Since palmitate is the most abundant circulating SFA, and myocellular accumulation of SFAs is inversely related to insulin sensitivity and muscle atrophy, an interesting question is whether DHA can prevent the negative effects of palmitate in muscle cells. In this regard, my master's graduate work demonstrated that co-treatment with DHA prevents the reduction in myotube diameter after 48 and 96 hours of palmitate treatment in C2C12 myotubes. The palmitate-induced myotube atrophy was associated with an increase in intramyocellular lipid accumulation and diminished growth signaling through Akt, and DHA prevented these responses [204]. The most striking findings in the study were the effects of the FAs on myotube morphology. Palmitate treatment led to a progressive decrease in myotube diameter and number and eventually caused death of all cells, whereas co-treatment with DHA not only protected myotubes from the effects of palmitate but actually improved the diameter and overall healthy appearance of the cells. Notably, most of the measurements were performed 48 or 96 hours after FA treatment when the morphology of the palmitate-treated cells had noticeably declined. Thus, the study revealed a promising protective effect of DHA that appears to counteract the

detrimental effects of SFAs in myotubes. Since alterations in signaling pathways precede the measurable responses, examination of potential pathways at earlier timepoints may reveal the underlying mechanisms responsible for the disparate effects of the FAs on myotube diameter. Therefore, the experiments in later chapters of this dissertation examine the more proximal signaling events that occur in myotubes in response to palmitate and/or DHA, prior to the development of overt morphological changes in the myotubes.

### **SUMMARY AND SIGNIFICANCE**

Loss of skeletal muscle mass in chronic illnesses like heart or renal failure, cancer, and diabetes significantly contributes to morbidity and mortality [247]. Currently there is a paucity of effective treatments for muscle atrophy [248]. While exercise training favors maintenance of muscle mass, for critically ill patients it is very difficult and often not a feasible option to counteract muscle loss. Additionally, targeted treatments such as proteasome inhibitors have been largely ineffective at maintaining muscle mass suggesting that ideal therapies would affect multiple proteolytic systems. A safe nutritional therapy is an ideal option, and several studies have demonstrated a beneficial effect of fish oil on muscle protein metabolism in animal models of atrophy [25, 37, 38] and human cancer patients [39]. However, these studies are somewhat difficult to interpret because fish oil is highly concentrated in both EPA and DHA. Several studies in animals [239-245] and one study in human cancer patients [237] have also shown that supplementation with EPA is beneficial for muscle mass, although with exception to one study of acute starvation in rats [245], these studies have all been focused on conditions

of severe inflammation and cancer-related illness and have not addressed other common conditions associated with muscle atrophy such as obesity, diabetes, and kidney disease.

Two of the three studies testing the effects of isolated DHA on muscle protein metabolism have utilized either myotube-macrophage co-cultures or high lipid levels to investigate its anti-atrophy potential in obesity and diabetes. Results from both of these studies show promise for DHA to counteract cellular signaling pathways that contribute to protein loss. However, the presence of two cell type is a confounding issue that prevents drawing a meaningful conclusion about the beneficial effects of PUFA on muscle cells. The experiments presented in this dissertation are the first to directly examine the effects of DHA on protein catabolism in muscle cells only.

Insulin-Akt signaling is a key regulator of protein balance in skeletal muscle, and there is evidence that DHA can maintain Akt signaling during atrophy-inducing conditions. ER stress and mitochondrial-mediated pathways are also critical mediators of the atrophy response; since DHA is the most highly enriched PUFA in the sarcoplasmic reticulum and mitochondrial membranes in skeletal muscle [44], it is plausible that DHA supplementation may improve functioning of these organelles in the face of cellular stress. There is evidence that DHA can attenuate the upregulation of these pathways in other cell types [217-219, 249-252]. Since the overarching objective of this project is to better understand how DHA prevents the atrophy-inducing responses to palmitate, we conducted experiments to elucidate how palmitate and DHA affect Akt signaling (Chapter 3) and ER stress pathways (Chapter 4). This information could provide a rationale for the use of DHA supplementation as a treatment for chronic illness-related muscle atrophy. Such an approach would be attractive because it is a nutritional therapy

that has numerous other positive effects on cardiovascular parameters that are also typically dysregulated in conditions associated with muscle atrophy (i.e. dyslipidemia) [253] and it poses a low chance for eliciting other undesired side effects. The results of this work indicate that DHA has the potential to alter numerous signaling pathways that control protein metabolism in skeletal muscle and warrant further research into the use of DHA as a treatment to counteract skeletal muscle atrophy.

**CHAPTER 3**

**DOCOSAHEXAENOIC ACID PREVENTS PALMITATE-INDUCED  
ACTIVATION OF PROTEOLYTIC SYSTEMS IN C2C12 MYOTUBES**

Myra E. Woodworth-Hobbs<sup>1,2</sup>, Matthew B. Hudson<sup>2</sup>, Jill A. Rahnert<sup>2</sup>, Bin Zheng<sup>2</sup>,  
Harold A. Franch<sup>2</sup>, S. Russ Price<sup>2,3</sup>

<sup>1</sup>Nutrition and Health Sciences Program, Graduate Division of Biological and Biomedical Sciences, Emory University, Atlanta, GA

<sup>2</sup>Department of Medicine, Renal Division, Emory University, Atlanta, GA

<sup>3</sup>Atlanta VA Medical Center, Decatur, GA

This chapter is published in *J Nutr Biochem* 2014 Aug;25(8):868-874



## INTRODUCTION

Skeletal muscle atrophy contributes to a debilitating loss of functional independence and increases the rate of mortality in individuals with numerous chronic illnesses, including diabetes, renal and heart failure, and cancer [247]. Currently there are few effective treatments that counteract muscle atrophy [248]. Lipotoxicity contributes to muscle atrophy in a number of conditions [59]. In obesity and type 2 diabetes, there is an increase in lipid flux and accumulation in skeletal muscle [198]. Recent evidence indicates that both the quantity and saturation of intramyocellular and extramyocellular lipid depots are elevated in skeletal muscle from diabetic patients compared to healthy controls [203]. Rodents that are fed a high-fat diet develop obesity and insulin resistance which have been linked to muscle atrophy [234]. Direct lipotoxicity is among the proposed mechanisms for obesity-related insulin resistance. In support of this hypothesis, treatment of cultured myotubes with the saturated fatty acid palmitate causes similar defects in insulin signaling and reduces myotube diameter [204].

Reduced insulin signaling through the protein kinase Akt can result in the loss of muscle protein through up-regulation of multiple proteolytic systems, including the ubiquitin-proteasome (UbP) and autophagy-lysosome pathways [102, 104]. Akt inactivates the Forkhead box (FoxO3) transcription factors, including FoxO3, which induce the expression of several key atrophy-inducing genes, termed “atrogenes,” including the muscle-specific E3 ubiquitin ligases MuRF1 and atrogin-1/MAFbx [103, 109] and the autophagy mediator Bnip3 [107]. Enhanced expression of MuRF-1 and atrogin-1/MAFbx is linked to muscle atrophy in a variety of disease models and targeted inactivation of either of them reduces muscle loss [48, 70, 74]. Bnip3 is important for

macroautophagic remodeling of the mitochondrial network [90]. Increasing expression of Bnip3 by constitutively active FoxO3 enhances macroautophagy and decreases muscle mass, while knockdown of Bnip3 reduces autophagosome formation induced by either constitutively active FoxO3 or fasting conditions [107]. LC3 is a small ubiquitin-like molecule required for membrane commitment and growth into autophagosomes [90]. It is enzymatically cleaved to form LC3-II, which allows the protein to localize to autophagosomes and bind phosphatidylethanolamine (i.e. undergo lipidation) [94]. Lipidated LC3-II binds to the cargo adaptor protein p62 which tags cellular targets for macroautophagy [95]. Thus, LC3-II is indicative of autophagosome formation [107].

Unlike saturated fatty acids, plasma levels of the polyunsaturated omega-3 fatty acids ( $\omega$ -3 FA) are positively correlated with insulin sensitivity in individuals with type 2 diabetes [11], and they prevent insulin resistance induced by saturated fatty acids in myotubes [188] and by high-fat feeding in rodents [23]. Apart from the effects on insulin sensitivity, there is other inferential evidence that  $\omega$ -3 FA may affect muscle mass. Transgenic *fat-1* mice have elevated endogenous  $\omega$ -3 FA levels, and their muscle fibers retain their cross-sectional areas following sciatic nerve injury compared to wild-type mice [206]. Supplementing the diets of rodents with fish oil, but not corn oil, prevents the increase in MuRF1 and atrogen-1 mRNA levels induced by hindlimb mobilization [37]. Fish oil supplementation also has beneficial effects on muscle mass in cancer patients undergoing chemotherapy [237]. Interpretation of the biological effects of  $\omega$ -3 FA on muscle mass in these studies is complicated because commercial fish oil is a highly enriched mixture of  $\omega$ -3 FA, including eicosapentaenoic acid (EPA) and docosahexaenoic acid (DHA) which are reported to exert different physiologic and

cellular effects [221, 254]. DHA is the terminal fatty acid in the omega-3 conversion pathway. Studies show that consumption of pre-formed DHA is the best way to increase its level in the blood while EPA is more readily formed from alpha-linolenic acid which is highly enriched in plant-based foods [254]. It was previously reported that co-treating C2C12 myotubes with DHA and palmitate protects them from atrophy induced by the saturated fatty acid [204]; however, the cellular processes underlying the fatty acid-induced alterations in protein metabolism remain unclear. Since it is well-established that FoxO3 mediates the loss of muscle protein in chronic illness by increasing protein degradation [90, 255], the purpose of this study was two-fold: to investigate whether palmitate increases protein degradation in muscle cells and whether DHA counters the atrophy-inducing effects of palmitate by restoring Akt/FoxO signaling. By using the C2C12 myotube model, we ensure that the observed responses to palmitate and DHA are due to their direct effects on muscle cells.

## **METHODS AND MATERIALS**

### ***Cultured myotube model***

Mouse C2C12 myoblasts (American Type Culture Collection, Manassas, VA, USA) were grown in Dulbecco's Modified Eagle Medium (DMEM) containing 4.5 g/L glucose and supplemented with 10% fetal bovine serum (FBS; Atlanta Biologicals, Lawrenceville, GA, USA) plus antibiotics (100 U/mL penicillin, 100 µg/mL streptomycin; Invitrogen, Carlsbad, CA, USA). At 90-95% confluence, cells were induced to differentiate into myotubes in DMEM containing 4.5 g/L glucose plus 2% horse serum (Invitrogen) and antibiotics for 3-4 days before treatment with fatty acids.

### Experimental treatments

Palmitic acid and cis-4, 7, 10, 13, 16, 19-docosahexaenoic acid (DHA) (Sigma Aldrich, St. Louis, MO, USA) were dissolved in ethanol and diluted to 500  $\mu\text{mol/L}$  and 100  $\mu\text{mol/L}$ , respectively, in DMEM containing 2% Fraction V protease-free bovine serum albumin (BSA; Product number 03117332001, Roche, Indianapolis, IN, USA), 2% FBS (Atlanta Biologicals, Inc., Flowery Branch, GA), 2 mmol/L L-carnitine (Sigma Aldrich), and 1% antibiotics (“treatment media”). Control cells were incubated in treatment media with an equal amount of ethanol substituted for palmitate and DHA. It is reported that 2% BSA and 500  $\mu\text{mol/L}$  free fatty acids result in a final molar ratio that closely resembles that of human plasma [184] and that fasting plasma nonesterified fatty acids are around 600  $\mu\text{mol/L}$  in obese adults with normal or impaired glucose tolerance or diabetes [195]. Additionally, the circulating level of palmitate is between 3-11 times higher than that of DHA in humans after 6 weeks of DHA supplementation [43]. Lastly, previous dose-response experiments in C2C12 myotubes showed that 100  $\mu\text{mol/L}$  was the lowest tested concentration of DHA that could prevent palmitate-induced defects in energy-sensing pathways [204]. Myotubes were incubated in treatment media for 2-24 h, as indicated in the figure legends. In some experiments to measure converted LC3-II, some myotubes were treated with 10 mmol/L methylamine (Tokyo Chemical Industry Co, Ltd, Tokyo, Japan) to inhibit lysosomal activity for 3 h prior to harvest.

### Protein degradation assay

Protein degradation was measured in differentiated myotubes as previously described [256]. Briefly, cellular proteins were radiolabeled with  $^{14}\text{C}$ -phenylalanine (Phe) for 48 h.

After a 2 h chase period to remove labeled Phe released from short-lived proteins, treatment media was applied and the amount of  $^{14}\text{C}$ -Phe released into the media was measured in serial aliquots at intervals up to 28 h. The rate of protein degradation was calculated as described by Gulve and Dice [257].

#### RNA isolation and qPCR analysis

RNA was isolated using TRIzol (Invitrogen) and reverse transcribed using the Superscript III First-Strand Synthesis kit (Invitrogen) according to the manufacturer's instructions. mRNA was measured using quantitative real time PCR with the BioRad iCycler and the iQ SYBR Green reagent (BioRad Laboratories, Hercules, CA, USA). Previously published primer sets for MuRF1, atrogin-1, and Bnip3 were used to perform PCR reactions [105, 107];  $\beta$ -actin was used as the normalization control. The data were analyzed for fold change ( $\Delta\Delta\text{Ct}$ ) using the iCycler software, as previously described [103]. Melting curve analyses were performed to analyze and verify the specificity of the reaction.

#### Isolation of cytosolic and nuclear cell fractions

Cells were rinsed 3 times and scraped from culture dishes in ice-cold phosphate-buffered saline (PBS), followed by centrifugation at  $1500 \times g$  for 5 min at  $4^\circ\text{C}$ . The pellet was re-suspended in a solution containing 0.01 mol/L HEPES (pH 7.6-7.8), 1.5 mmol/L  $\text{MgCl}_2$ , 2 mmol/L KCl, 0.5 mmol/L DTT, 0.5 mmol/L PMSF, 10  $\mu\text{g}/\text{mL}$  aprotinin, 5  $\mu\text{g}/\text{mL}$  leupeptin, 5  $\mu\text{g}/\text{mL}$  pepstatin A, and 1 mmol/L sodium orthovanadate and incubated on ice for 15 min. After addition of Nonidet P-40 (final concentration

0.5%), samples were mixed vigorously for 10 seconds and centrifuged at  $1500 \times g$  for 30-60 seconds at  $4^{\circ}\text{C}$ . The supernatant (cytosolic fraction) was transferred to a new tube and stored at  $-80^{\circ}\text{C}$  until further analysis. The pellet was re-suspended in a solution containing 0.02 mmol/L HEPES (pH 7.6-7.8), 1.5 mmol/L  $\text{MgCl}_2$ , 2 mmol/L KCl, 0.4 mol/L NaCl, 0.2 mmol/L EDTA, 0.5 mmol/L DTT, 0.5 mmol/L PMSF, 10  $\mu\text{g}/\text{mL}$  aprotinin, 5  $\mu\text{g}/\text{mL}$  leupeptin, 5  $\mu\text{g}/\text{mL}$  pepstatin A, 1 mmol/L sodium orthovanadate, and 25% glycerol, and samples were incubated on a shaking platform for 15-60 min at  $4^{\circ}\text{C}$ . Samples were centrifuged at  $21000 \times g$  for 20 min at  $4^{\circ}\text{C}$ , and the supernatant (nuclear fraction) was transferred to a new tube and stored at  $-80^{\circ}\text{C}$  until further analysis.

#### Western blot analysis

Whole cell lysates were prepared using the buffers specified by the antibody vendors. Protein concentrations of cleared lysates, including the cytosolic and nuclear fractions described above, were measured using a BioRad DC protein assay kit (BioRad Laboratories). Western analyses were performed as described [89] using commercial antibodies to phospho-Akt (S473), total Akt, FoxO3a, LC3B,  $\beta$ -actin (Cell Signaling Technology, Beverly, MA, USA), and p62 (Sigma Aldrich) [103]. Antibodies to GAPDH, Histone H1 (Santa Cruz Biotechnology, Santa Cruz, CA, USA), and  $\text{Na}^+/\text{K}^+$  ATPase (Cell Signaling Technology) were used to assess the purity of the nuclear and cytosolic samples. Equal loading of total protein in the sample lanes was verified by Ponceau S Red staining [103].

### Statistical analyses

Data are presented as mean percentage of control  $\pm$  SE. Differences between 2 treatment groups are compared by two-tailed Student's *t* test. Differences between  $\geq 3$  treatments are compared by one-way ANOVA with post-hoc analysis by Tukey's test for multiple comparisons. Results are considered statistically significant at  $P < 0.05$ .

## **RESULTS**

### DHA attenuates the effects of palmitate on protein degradation.

Previous experiments in C2C12 myotubes indicated that addition of DHA reverses the reduction in myotube size induced by palmitate [204]. To determine if changes in protein degradation contribute to these responses, we measured the rate of protein degradation in myotubes treated with each lipid alone and in combination. Palmitate alone increased proteolysis by 31% whereas DHA alone had no effect on the rate of proteolysis (**Figure 3.1**). Co-treatment of DHA with palmitate prevented the proteolytic response to the saturated fatty acid.

### DHA attenuates palmitate-induced inhibition of Akt-FoxO3 signaling.

Akt is a key regulator of protein degradation in muscle because it phosphorylates FoxO3, thereby inhibiting its function. We therefore tested whether palmitate and DHA alter the Akt/FoxO3 pathway. Treating myotubes with palmitate consistently suppressed the phospho:total Akt ratio over treatment times between 2-24 h (**Figure 3.2A**). DHA alone had no effect on Akt phosphorylation whereas co-treatment of myotubes with DHA and palmitate for 4 h (**Figure 3.2B**) and 24 h (**Figure 3.2C**) restored Akt phosphorylation

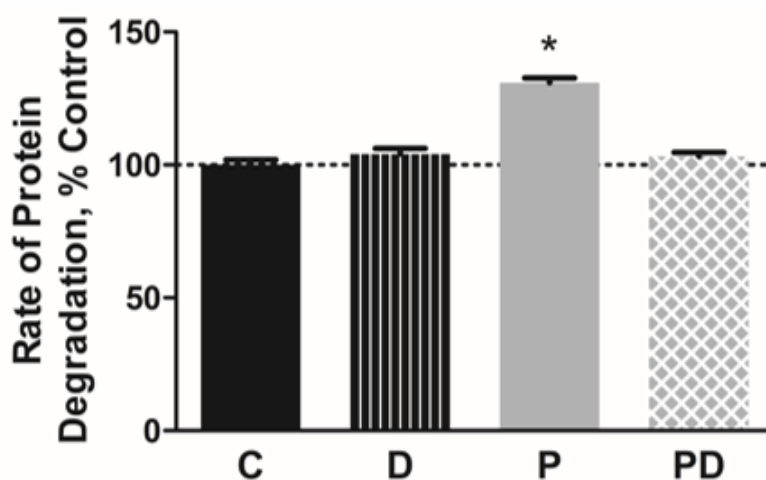

*Figure 3.1. Docosahexaenoic acid prevents palmitate-induced protein degradation.* C2C12 myotubes were pre-labeled with  $^{14}\text{C}$ -phenylalanine then treated with 500  $\mu\text{mol/L}$  palmitate (PA) and/or 100  $\mu\text{mol/L}$  docosahexaenoic acid (DHA) for 28 h. The rate of protein degradation was calculated by measuring the release of  $^{14}\text{C}$ -phenylalanine into the culture media. PA increased the rate of protein degradation, while co-treatment with DHA prevented the response. Representative results from 1 of 3 independent experiments are shown (\* $p < 0.01$  versus other groups,  $n = 6$  per group per experiment).



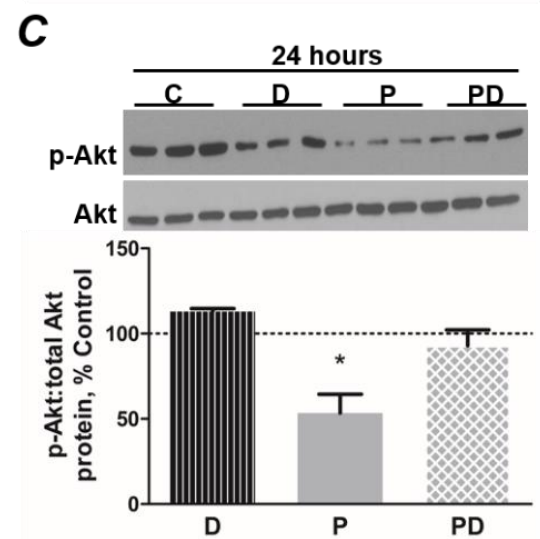
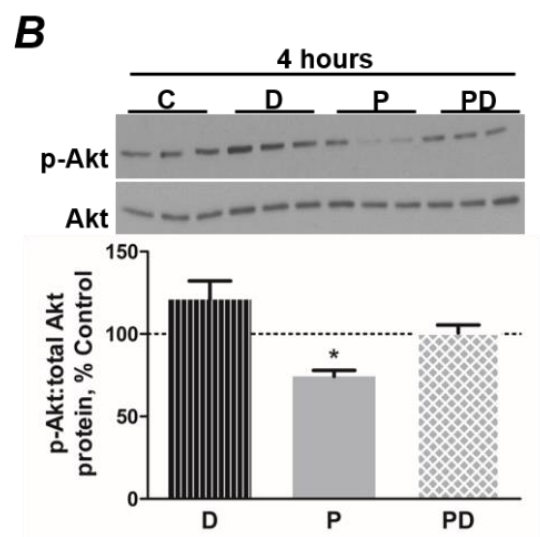
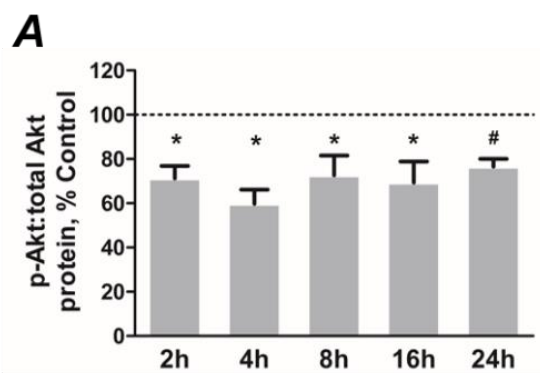

**Figure 3.2. DHA prevents palmitate-induced suppression of Akt activation.** C2C12 myotubes were treated with 500  $\mu\text{mol/L}$  PA (P) for 2-24 h and the protein levels of phospho(S473)-Akt and total Akt were evaluated by western blot analysis. **A)** PA reduced the ratio of phospho(S473):total Akt at all timepoints, indicating a continuous suppression of Akt activation by the saturated fatty acid (\* $p < 0.05$  versus control,  $n = 3-5$ /timepoints; # $p < 0.01$  versus control,  $n = 5$ /timepoint). **B/C)** Co-treatment with 100  $\mu\text{mol/L}$  DHA (PD) attenuates the effects of PA on the Akt ratio after **B)** 4 h (\* $p < 0.01$  versus all other groups,  $n = 3-4$ /group) and **C)** 24 h (\* $p < 0.001$  versus all other groups,  $n = 5-6$ /group).

to near control levels. The lack of reduction in Akt activation by DHA was not simply due to a lower molarity of fatty acid compared to palmitate because we tested 500  $\mu\text{mol/L}$  DHA and it improved Akt phosphorylation compared to control samples (data not shown). This indicates that the type of fatty acid, rather than concentration, is primarily responsible for their disparate effects on Akt signaling in this model.

The level of FoxO3 protein in total cell lysates was unchanged by the fatty acid treatments (**Figure 3.3A**). Examination of cytosolic and nuclear cell fractions revealed that palmitate decreased FoxO3 protein in the cytosol (**Figure 3.3B**) while simultaneously increasing its level in the nucleus (**Figure 3.3C**). Co-treatment with DHA restored the levels of FoxO3 in the cytosol and nucleus to control levels (**Figures 3.3B and 3.3C**). The purity of the cytosolic and nuclear fractions was evaluated by testing for the presence of glyceraldehyde-3-phosphate dehydrogenase (GAPDH, cytosolic),  $\text{Na}^+\text{-K}^+$  ATPase (cell membrane) and histone H1 (nuclear) proteins in each of the samples. No obvious contamination between fractions was detected (**Figure 3.3D**).

*DHA attenuates the effects of palmitate on proteolytic systems.*

FoxO3 promotes protein degradation by enhancing expression of key components of multiple proteolytic systems. Therefore, we evaluated whether the fatty acid treatments altered markers of the UbP and autophagy pathways. Palmitate increased the level of E3 ubiquitin ligase atrogin-1/MAFbx mRNA after 4 h compared to control cells, while co-treatment with DHA prevented the response (**Figure 3.4A**). Surprisingly, the level of MuRF1 mRNA was unchanged by treatment with the fatty acids (**Figure 3.4B**).

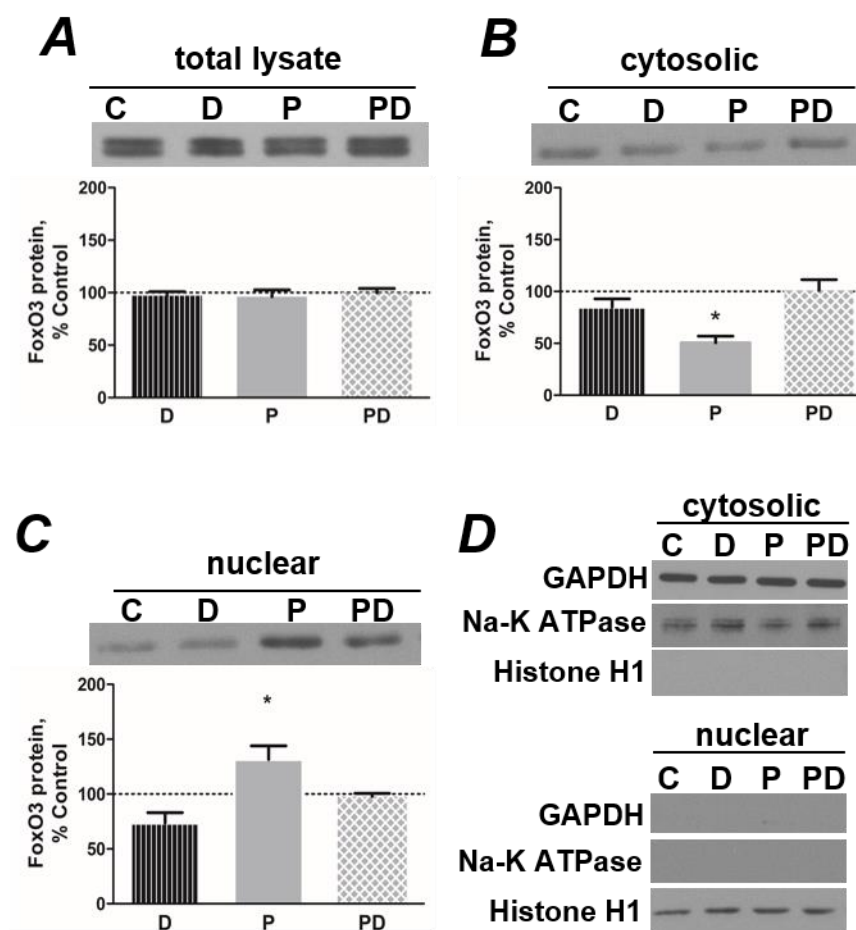

**Figure 3.3. Co-treatment with DHA prevents palmitate-induced alterations in FoxO3 localization.** A) Treatment (4 h) with 500  $\mu\text{mol/L}$  PA (P) and/or 100  $\mu\text{mol/L}$  DHA (D) does not alter FoxO3 protein in total cell lysates ( $n=3/\text{group}$ ). PA decreases cytosolic (B) and increases nuclear FoxO3 protein (C), while co-treatment with DHA (PD) prevents the responses ( $*p<0.01$  versus all other groups,  $n=4/\text{group}$ ). D) Representative western blots show markers of cytosolic (GAPDH), nuclear (histone H1), and cell membrane ( $\text{Na}^+/\text{K}^+$  ATPase) proteins to confirm the purity of cell fractions.

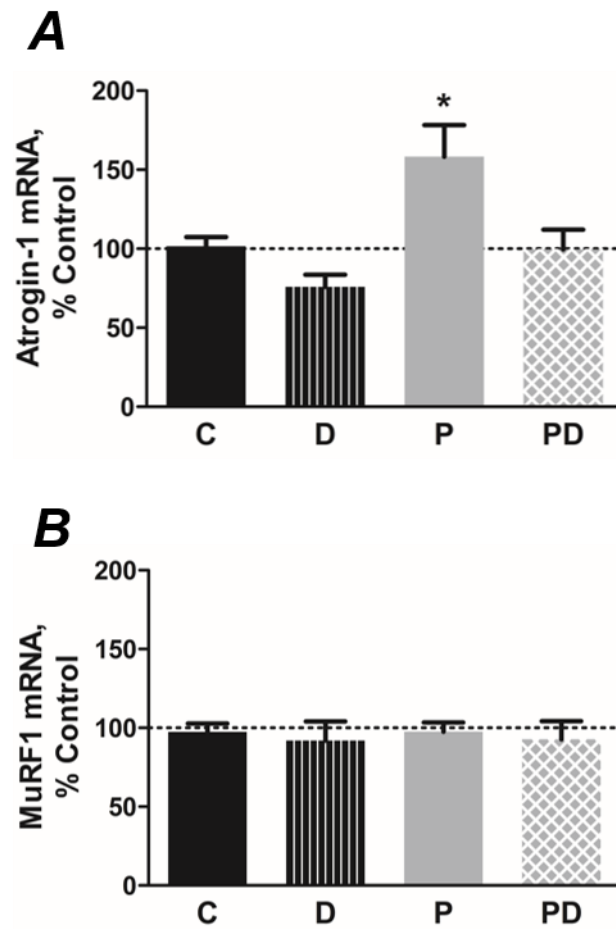
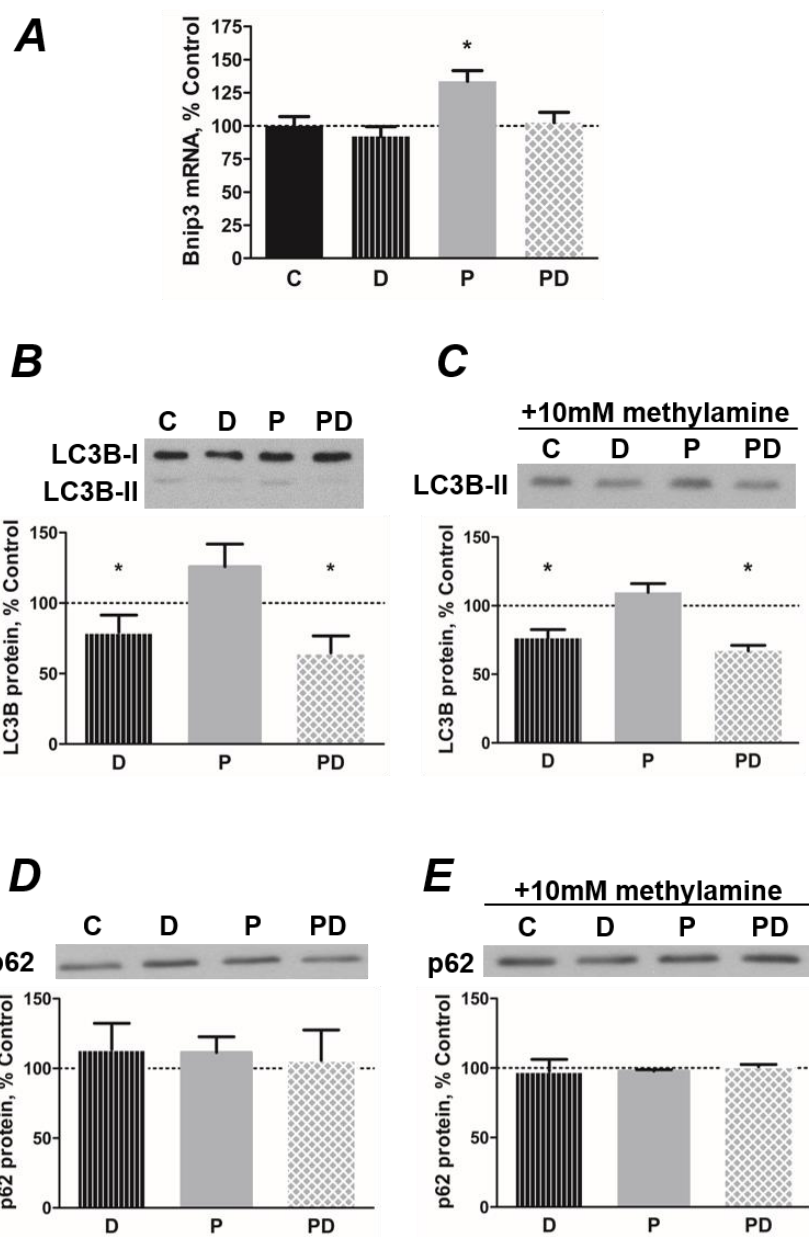

**Figure 3.4. Co-treatment with DHA prevents the PA-induced increase in atrogin-1 mRNA levels.** **A)** PA (P; 500  $\mu\text{mol/L}$ , 4 h) increases mRNA encoding the muscle-specific E3 ubiquitin ligase atrogin-1 (\* $p < 0.01$  versus all other groups,  $n = 8-12/\text{group}$ ), while co-treatment with 100  $\mu\text{mol/L}$  DHA (PD) prevents these responses. **B)** mRNA encoding the MuRF-1 E3 ligase is unchanged by fatty acids (4 h,  $n = 7/\text{group}$ ).

Regarding macroautophagy, palmitate increased the level of Bnip3 mRNA whereas co-treatment with DHA reduced the level to that in control cells (**Figure 3.5A**). LC3-II protein was unchanged by palmitate but was reduced by DHA, regardless of whether palmitate was present (**Figure 3.5B**). To test whether DHA regulates the rate of autophagosome formation, degradation of LC3-II-containing autophagosomes was inhibited by adding methylamine to the media. The level of LC3-II was still reduced in DHA-treated cells after inhibition of lysosomal activity, indicating that DHA significantly reduces autophagic flux while palmitate has no effect (**Figure 3.5C**). The levels of p62 were not altered by either fatty acid, regardless of whether lysosomes were active or not (**Figures 3.5D and 3.5E**).

## DISCUSSION

The objective of this study was to determine whether palmitate enhances protein degradation in myotubes and to investigate how DHA protects against palmitate-induced muscle atrophy. We hypothesized that DHA antagonizes the effects of palmitate on the Akt/FoxO3 axis because it is a key determinant of the activity of various proteolytic pathways in muscle cells. Our findings indicate that DHA counteracts the palmitate-induced increase in protein degradation by preventing the upregulation of the UbP and autophagy systems. DHA's effects are mediated, at least in part, through restoration of Akt activation and FoxO3 inhibition (**Figure 3.6**). Although several *in vivo* studies have documented that  $\omega$ -3 fatty acids, primarily in the form of fish oil, exert beneficial effects on protein metabolism in muscle [37, 206, 237], it remained unclear whether these fatty acids directly target muscle signaling pathways that control protein balance or exert



**Figure 3.5. Co-treatment with DHA prevents the PA-induced increase in macroautophagy.**

A) PA (P; 500  $\mu\text{mol/L}$ , 24 h) increases mRNA levels of the macroautophagy mediator Bnip3, while co-treatment with 100  $\mu\text{mol/L}$  DHA (PD) prevents the response (\* $p < 0.01$  versus all other groups,  $n = 5-6$ ). B/C) DHA inhibits autophagosome formation. B) DHA decreases the ratio of LC3B-II:LC3B-I protein in the absence (D) or presence (PD) of PA (24 h, \* $p < 0.05$  versus PA,  $n = 4$ ). C) Myotubes were treated with 10  $\text{mmol/L}$  methylamine to inhibit lysosomal degradation of autophagosome contents for 3 h before lysis. The level of LC3B-II protein remained decreased, indicating an independent effect of the omega-3 fatty acid to inhibit macroautophagy (24 h, \* $p < 0.001$  versus control and PA,  $n = 3/\text{group}$ ). D/E) p62 protein levels remain unchanged by treatment with PA or DHA for 24 h in the D) absence ( $n = 4/\text{group}$ ) or E) presence ( $n = 3/\text{group}$ ) of 10  $\text{mmol/L}$  methylamine.



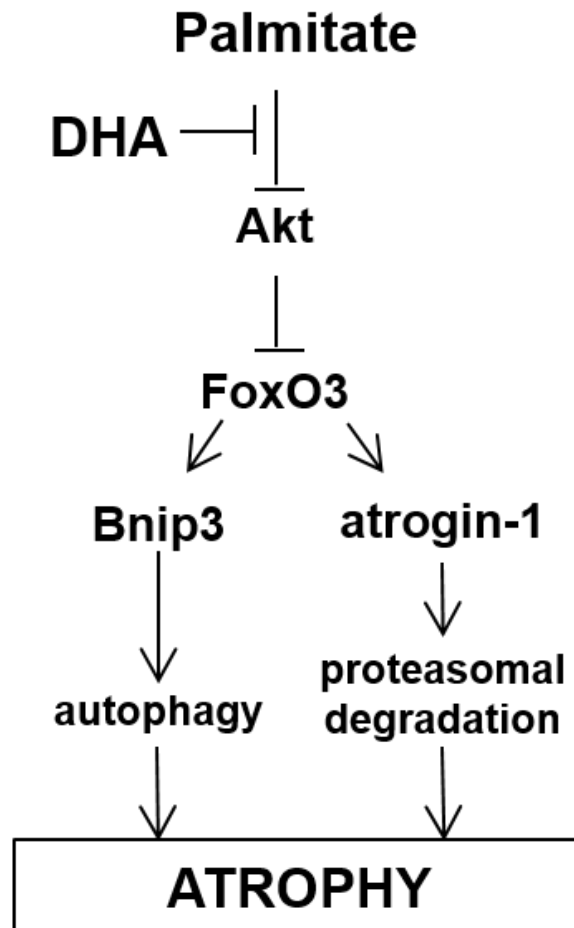

**Figure 3.6.** The Akt/FoxO3 axis is a key regulator of the activity of various proteolytic pathways in muscle cells, including the ubiquitin-proteasome and macroautophagy systems. Palmitate induces the activity of multiple proteolytic systems, resulting in myotube atrophy. DHA counteracts the effects of palmitate by restoring Akt activation and FoxO3 inhibition, thus preventing the upregulation of protein degradation.

indirect effects on muscle via systemic metabolic alterations. The current experiments establish that  $\omega$ -3 fatty acids, specifically DHA, act directly on myotubes to regulate proteolytic pathways in a high fat environment.

Previous experiments demonstrated that co-treatment with DHA prevents the palmitate-induced decrease in the diameter of C2C12 myotubes [204]. To elucidate the mechanisms underlying the anti-atrophy effect of DHA, we first determined whether the fatty acids altered the rate of protein degradation in myotubes. As hypothesized, palmitate increased proteolysis while co-treatment with DHA inhibited the effect of palmitate. Consistent with an earlier study [238], DHA alone did not alter the rate of protein degradation. Although the present work does not address the possibility that DHA alters protein synthesis, the earlier report indicated that 50  $\mu$ mol/L DHA had no effect on the process in C2C12 myotubes [238]. This finding, however, does not preclude the possibility that DHA prevents a negative effect of palmitate on protein synthesis. Regardless, our results indicate that the beneficial effects of DHA are more apparent in the presence of an atrophy-inducing signal such as palmitate.

Akt is a key regulator of protein degradation in skeletal muscle. Under normal healthy conditions, it inactivates FoxO3 through phosphorylation, thereby inhibiting its nuclear localization and suppressing the expression of key components of the muscle cell's proteolytic systems [99]. Reduced signaling through Akt is a common feature of most cell and animal models of atrophy [104]. In agreement with other studies [183, 215, 228], palmitate caused a prolonged suppression of Akt activation, as indicated by decreased phospho:total Akt ratio compared to control cells. Coincident with the change in Akt phosphorylation, the level of nuclear Foxo3 also increased. Importantly, co-treatment

with DHA preserved Akt activation as well as restored cytosolic and nuclear FoxO3 protein to control levels. This suggests that the protective effect of DHA against palmitate-induced protein degradation is mediated, at least in part, by reestablishing a normal Akt/FoxO3 axis.

Activation of FoxO3 stimulates multiple proteolytic systems, including the UbP and autophagy pathways. The muscle-specific E3 ubiquitin ligases MuRF1 and atrogin-1/MAFbx are key components of the atrophy program that selectively target specific muscle proteins for ubiquitination and degradation by the 26S proteasome [70, 74]. Their mRNAs are typically elevated in models of atrophy [48, 70]. Overexpression of MAFbx is sufficient to induce atrophy in myotubes, while MAFbx/atrogin-1 or MuRF1 deficiency attenuates muscle loss due to denervation in mice [74]. We hypothesized that the palmitate-induced enhancement in nuclear localization of FoxO3 would result in increased expression of atrophy-related FoxO3 targets. Consistent with this prediction, increased atrogin-1 mRNA expression indicates that the UbP plays a role in palmitate-induced protein degradation. The effects of DHA on atrogene expression have not been investigated previously in a high fat model. Our finding that co-treatment with DHA prevented the palmitate-induced increase in atrogin-1 mRNA further supports the assertion that DHA plays a protective role against the atrophy-inducing effects of palmitate by restoring inhibition of FoxO3 and reducing proteolysis.

Unexpectedly, palmitate increased the level of mRNA encoding atrogin-1 but not MuRF1. Although this is an unusual result, it is not without precedent and may be attributable to the atrophy stimulus in our high fat model. Finlin and colleagues [229] reported that incubating C2C12 myotubes with 200  $\mu\text{mol/L}$  palmitate increased the

mRNA for atrogin-1, but not MuRF1; in these experiments, myotubes were co-cultured with either fibroblasts or macrophages. They also noted that 200  $\mu\text{mol/L}$  DHA did not alter the expression of either atrogene (in the absence of palmitate) [229]. Again, this is consistent with our data and further suggests that the disparate effects of palmitate and DHA on atrogene expression are not due to differences in molarity of the fatty acids. We also examined this possibility by incubating myotubes with 500  $\mu\text{mol/L}$  DHA and/or 500  $\mu\text{mol/L}$  palmitate and found no reduction in the phospho-Akt:total Akt ratio due to the higher concentration of DHA (data not shown), confirming that a higher concentration of DHA does not have detrimental effects akin to those of palmitate.

Until recently, the importance of the autophagy pathway in skeletal muscle atrophy has been underappreciated. Several studies have identified autophagy-related atrogene mRNAs, including Bnip3 and LC3, which are increased in some models of atrophy [90, 258]. Mammucari et al. [107] demonstrated that a FoxO3-mediated increase in Bnip3, but not LC3, is necessary and sufficient to induce autophagy and muscle atrophy. In the current study, co-treatment with DHA counteracted the induction of Bnip3 mRNA by palmitate. Surprisingly, palmitate did not significantly increase LC3-II or alter p62 protein; however, DHA did decrease autophagosome formation regardless of whether palmitate was present or not. Therefore, it appears that DHA has an independent effect to inhibit autophagy in muscle cells. This effect alone is not sufficient to significantly reduce the overall rate of protein degradation (Fig. 1), likely because macroautophagy quantitatively represents only a small fraction of total cellular proteolysis in skeletal muscle [66]. Others have suggested that mitochondria may be a critical target for macroautophagy in muscle wasting [90]. This is an interesting corollary to the present

work and could be the basis of future experiments to delineate the effects of DHA and palmitate on mitochondrial number and function.

In summary, our data demonstrate that a palmitate-induced increase in protein degradation via suppression of Akt/FoxO3 signaling and induction of the UbP and autophagy pathways contributes to the muscle cell atrophy seen with lipotoxicity. DHA, a major  $\omega$ -3 fatty acid constituent of fish oil, protects against the detrimental effects of palmitate. It acts by reestablishing the Akt-mediated inhibition of FoxO3, thereby suppressing atrogenic expression and limiting induction of autophagy. These results underscore the potential for future therapeutic application of the omega-3 fatty acids in counteracting muscle loss due to chronic illness.

#### **ACKNOWLEDGEMENTS**

The authors would like to thank Sara Zoromsky for her assistance with the protein degradation assay.

**CHAPTER 4**

**DOCOSAHEXAENOIC ACID COUNTERACTS PALMITATE-INDUCED ER  
STRESS IN C2C12 MYOTUBES: INSIGHTS INTO FATTY ACID-INDUCED  
MUSCLE ATROPHY**

Myra E. Woodworth-Hobbs<sup>1,2</sup> and S. Russ Price<sup>2,3</sup>

<sup>1</sup>Nutrition and Health Sciences Program, Graduate Division of Biological and Biomedical Sciences, Emory University, Atlanta, GA

<sup>2</sup>Department of Medicine, Renal Division, Emory University, Atlanta, GA

<sup>3</sup>Atlanta VA Medical Center, Decatur, GA

## BACKGROUND

Accumulation of fatty acids in skeletal muscle can cause lipotoxic effects such as cell stress, suppression of insulin signaling and dysregulation of protein metabolism, all of which directly or indirectly lead to atrophy. Long-term treatment of cultured myotubes with the saturated fatty acid palmitate results in a significant loss of myotube diameter [204]. We recently demonstrated that palmitate increases the rate of protein degradation in myotubes, at least in part by reducing the Akt-mediated inhibition of the ubiquitin-proteasome and autophagy pathways [259]. Palmitate and high fat diet have also been shown to induce endoplasmic reticulum (ER) stress in cultured myotubes and rodent skeletal muscle, respectively [34, 214]. Activation of these pathways can result in perturbations in protein metabolism and also lead to loss of mitochondrial stability which leads to activation of caspase-mediated proteolysis. Since these responses can contribute to the atrophy phenotype, it is possible that fatty acid-induced ER stress is a component of the proteolytic response.

Three distinct ER stress transducers – protein kinase R-like ER protein kinase (PERK), inositol requiring enzyme 1 alpha (IRE1 $\alpha$ ), and activating transcription factor 6 (ATF6) – orchestrate a series of cellular events, collectively termed the unfolded protein response (UPR), that enable cells to adapt to ER stress. Initial UPR events include suppression of global protein synthesis, improved folding capacity of nascent proteins in the ER through selective transcription of a subset of genes, and removal of misfolded or unfolded proteins from the ER via ER-associated degradation pathways (ERAD) [117]. PERK activation is an early event in the UPR that initiates signaling pathways to resolve ER stress through these mechanisms [8]. Activated PERK phosphorylates eukaryotic

initiation factor 2 $\alpha$  (eIF2 $\alpha$ ), a response that reduces the available eIF2•GTP•Met-tRNA<sub>i</sub> complex and suppresses global protein synthesis to reduce ER client protein load [130]. Mutation of the PERK gene impairs the ability of cells to survive ER stress via an inability to limit synthesis of new proteins, a finding which suggests that PERK is required for the adaptive response to ER stress [134]. The UPR activation of ER-associated degradation (ERAD) pathways also facilitates the retro-translocation of misfolded and unfolded proteins into the cytosol for degradation by the 26S proteasome [144] as well as the removal of damaged ER and insoluble protein aggregates via autophagy [128]. In some cell types, PERK signaling activates autophagy by increasing the mRNA expression of autophagy-related 12 (Atg12) and Atg5, which are required for autophagosome formation [139]. It remains unclear which downstream target of PERK is responsible for this transcriptional activation and whether this pathway regulates autophagy in myotubes.

Failure to resolve prolonged or severe ER stress can result in cell death. The PERK/eIF2 $\alpha$  pathway preferentially enhances the translation of ATF4 (activating transcription factor 4) [135], which under continued ER stress promotes cell death by inducing gene expression of CCAAT-enhancer binding protein homologous protein (CHOP) [136]. Deletion of CHOP protects against ER stress-induced cell death [154]. While CHOP is a downstream effector of all three arms of the UPR, ATF4 is required for CHOP transcription [133]. ATF4 gene expression is highly induced in muscle during diabetes and renal failure [70] and is required for fasting-induced myofiber atrophy [163]. ER stress cell death signals converge on the mitochondria and eventually lead to activation (i.e. cleavage) of caspase-3 [149]. Caspase-3 activation is an important step in



the progressive loss of muscle protein due to chronic illness because inhibition of caspase-3 attenuates disuse atrophy in the diaphragm [84] and the diabetes-associated enhanced proteolytic cleavage of actin [83].

The palmitate-induced decrease in myotube diameter is prevented by co-addition of the omega-3 polyunsaturated fatty acid docosahexaenoic acid (DHA) [33]. DHA protects against ER stress in neurons [215]. It also prevents activation of caspase-3 in retinal cells [218]. In light of our recent findings that DHA normalizes the rate of protein degradation by reducing activation of proteolytic systems [259], we hypothesized that DHA counters the palmitate-induced activation of ER stress responses and caspase-3 in myotubes.

## **METHODS AND MATERIALS**

### ***Cultured myotube model***

Mouse C2C12 myoblasts (American Type Culture Collection, Manassas, VA, USA) were grown in Dulbecco's Modified Eagle Medium (DMEM) containing 4.5 g/L glucose and supplemented with 10% fetal bovine serum (FBS; Atlanta Biologicals, Lawrenceville, GA, USA) plus antibiotics (100 U/mL penicillin, 100 µg/mL streptomycin; Invitrogen, Carlsbad, CA, USA). When cells were 90-95% confluent, the media was switched to DMEM containing 4.5 g/L glucose plus 2% horse serum (Invitrogen) and antibiotics cells to induce differentiation into myotubes for 3-4 days before treatment with fatty acids.

### Experimental treatments

Palmitic acid (PA) and cis-4, 7, 10, 13, 16, 19-docosahexaenoic acid (DHA) (Sigma Aldrich, St. Louis, MO, USA) were dissolved in ethanol and diluted to 500  $\mu\text{mol/L}$  and 100  $\mu\text{mol/L}$ , respectively, in DMEM containing 2% bovine serum albumin (BSA; Roche, Indianapolis, IN, USA), 2% FBS, 2 mmol/L L-carnitine (Sigma Aldrich), and 1% antibiotics (treatment media). Control cells were incubated in treatment media with an equal amount of ethanol substituted for PA and DHA. Myotubes were incubated in treatment media for 24 h. In some experiments, thapsigargin (1  $\mu\text{mol/L}$ ) was added to some cells to induce ER stress as described [212].

### RNA isolation and qPCR analysis

RNA was isolated using TRIzol (Invitrogen) and reverse transcribed using the Superscript III First-Strand Synthesis kit (Invitrogen) according to the manufacturer's instructions. Specific mRNAs were measured by quantitative real time PCR in a BioRad iCycler with iQ SYBR Green reagent (BioRad Laboratories, Hercules, CA, USA) and previously published primer sets for ATF4 [163], CHOP, XBP1s [212], Atg5 [260], and Atg12 [261];  $\beta$ -actin was used as the normalization control. The data were analyzed for fold change ( $\Delta\Delta\text{Ct}$ ) using the iCycler software, as described [103]. Melting curve analyses were performed to verify the specificity of the reactions.

### Western blot analysis

Whole cell lysates were prepared using the buffers specified by the antibody vendors. Protein concentrations of cleared lysates were measured using a BioRad DC protein assay

(BioRad Laboratories). Western blot analyses were performed as described [89] using commercial antibodies to phospho-PERK (T980), PERK, phospho-eIF2 $\alpha$ (S51), eIF2 $\alpha$ , CHOP, cleaved caspase-3 (Cell Signaling Technology, Beverly, MA, USA), and Nrf2 (Enzo Life Sciences, Farmingdale, NY, USA). Equal loading of total protein in the sample lanes was verified after protein transfer by Ponceau S Red staining [103].

### Statistical analyses

Data are presented as mean percentage of control  $\pm$  SE. Differences between treatments are compared by one-way ANOVA with post-hoc analysis by Tukey's test for multiple comparisons. For some western blots (i.e. cleaved caspase-3 and CHOP), bands were undetectable in some lanes even after extensive exposures. In these cases, the data were analyzed using the Freeman-Halton extension of the Fisher's exact probability test. Results are considered statistically significant at  $P < 0.05$ .

## **RESULTS**

### DHA attenuates the induction of ER stress by palmitate

An essential early response to ER stress is the PERK-mediated decrease in global protein synthesis to reduce ER client protein load. ER stress causes dissociation of PERK from the protein chaperone BiP [118]; subsequent dimerization and trans-autophosphorylation of PERK's cytosolic domain activates its protein kinase activity which can be measured by phosphorylation of threonine-980 (T980). Palmitate increased the amount of phospho-PERK(T980) by over 5-fold (**Fig. 4.1A**) and total PERK protein was reduced by 44% (**Fig. 4.1B**). This resulted in a 9.8-fold increase in the phospho:total

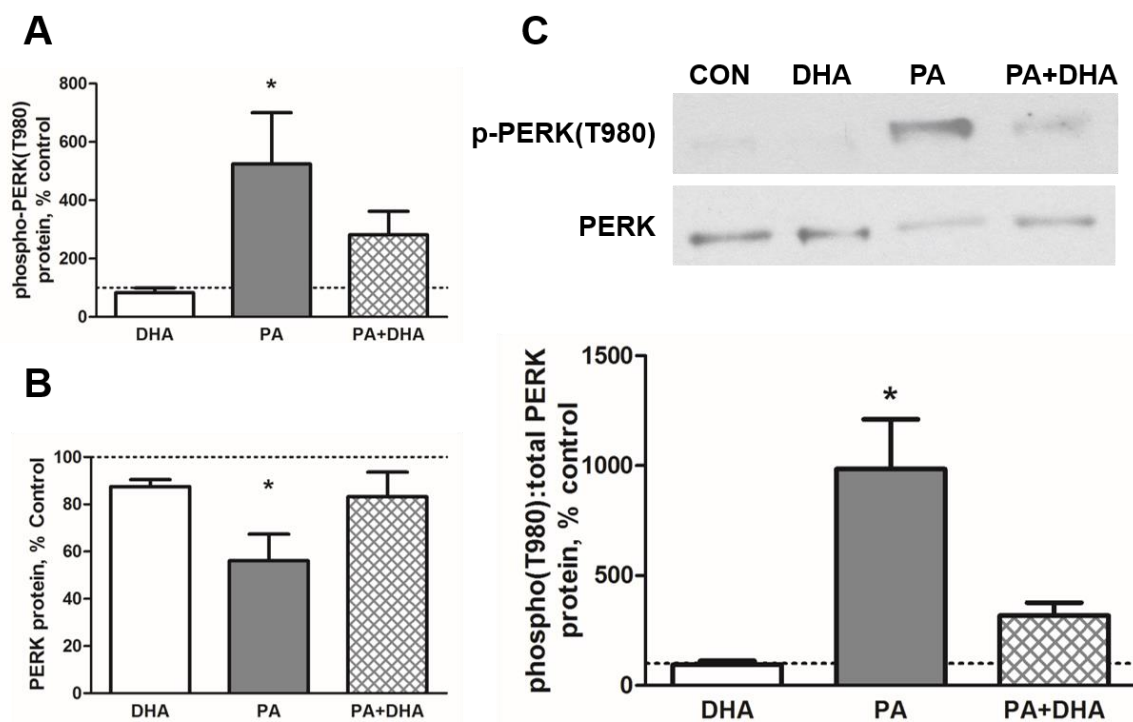
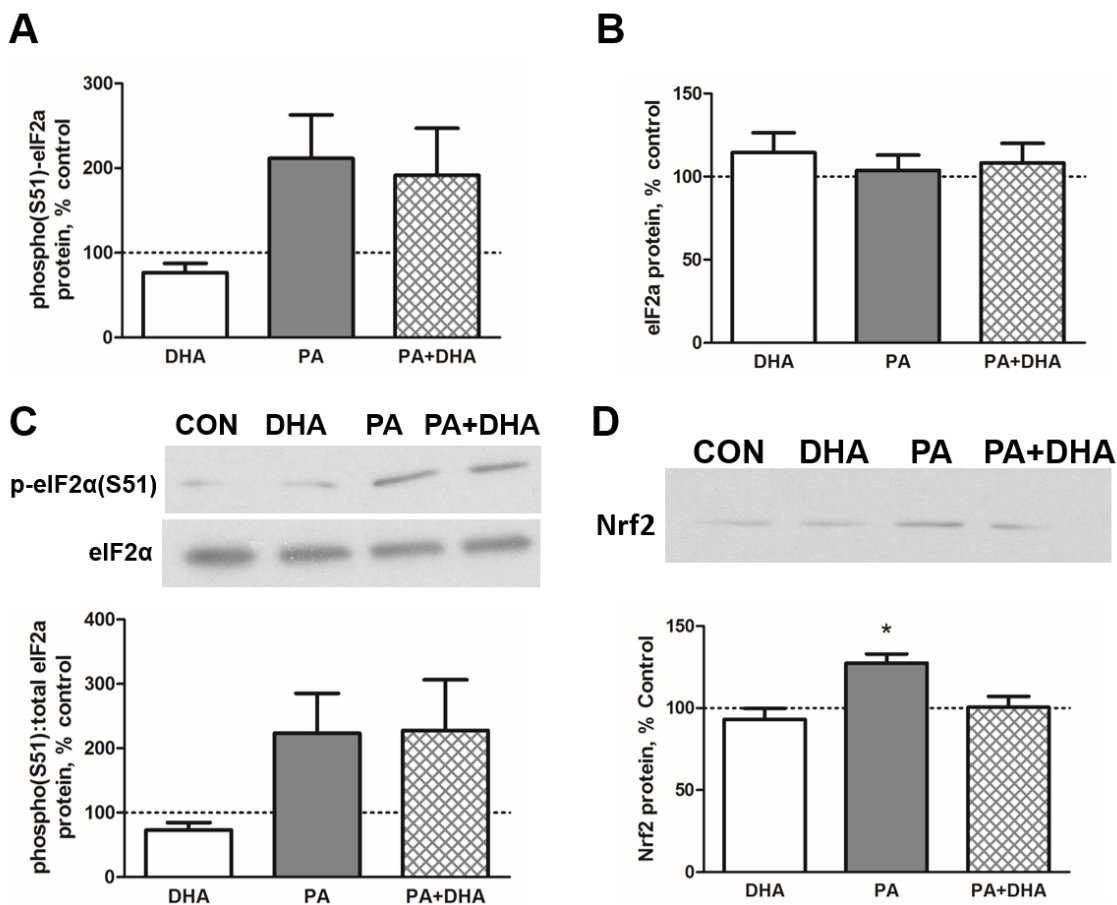

**Figure 4.1. Co-treatment with DHA attenuates the palmitate (PA)-induced increase in PERK activation.** A) PA increases phosphorylation of PERK (\* $p < 0.05$  versus control and DHA,  $n = 5$ ) and B) decreases total PERK protein (\* $p < 0.01$  versus control). C) Co-treatment with DHA attenuates the PA-induced increase in the p-PERK(T980):total PERK ratio (\* $p < 0.001$  versus all other groups). Representative western blots show phospho-PERK and total PERK proteins.

PERK ratio (**Fig. 4.1C**). The suppression of global protein synthesis by PERK depends on its deactivating phosphorylation of eIF2 $\alpha$  on serine 51. Accordingly, palmitate increased phospho-eIF2 $\alpha$  by approximately 2-fold (**Fig. 4.2A**). Analysis by one-way ANOVA indicated an overall significant difference between group means, subsequent pairwise comparisons did not detect a significant difference in phospho-eIF2 $\alpha$  between palmitate and any other group. Total eIF2 $\alpha$  protein did not change with any fatty acid treatment (**Fig. 4.2B**). Although the phospho:total eIF2 $\alpha$  ratio was increased by over 2-fold in palmitate-treated myotubes, the overall ANOVA was  $p < 0.07$  and was not statistically significant (**Fig. 4.2C**). To determine if DHA could prevent PERK activation and relieve its inhibition of eIF2 $\alpha$ , we co-treated myotubes with palmitate and DHA. While DHA attenuated the palmitate-induced increase in PERK activation (**Fig. 4.1**), it did not relieve the inhibition of eIF2 $\alpha$  (**Fig. 4.2A, C**). To confirm the effects of palmitate and DHA on PERK activation, we also measured another direct PERK target, nuclear factor erythroid 2-related factor (Nrf2). The phosphorylation of Nrf2 by PERK is stabilizing and results in an increased total level of Nrf2 protein [139]. Palmitate increased the level of Nrf2 protein, and notably, co-treatment with DHA prevented this response (**Fig. 4.2D**).

*DHA prevents palmitate-induced activation of ER stress-associated proteolytic pathways*

In most cell types, when ER stress remains unresolved, the UPR transitions from mediating an adaptive, survival response to promoting cell death. In contrast, prolonged or severe ER stress results in mitochondrial instability and caspase-mediated proteolysis



**Figure 4.2. Co-treatment with DHA does not reduce PA-induced phosphorylation of eIF2 $\alpha$ .**

A) PA and DHA tend to increase the phosphorylation of eIF2 $\alpha$  (overall ANOVA  $p=0.048$ ,  $n=7$ ), while B) total eIF2 $\alpha$  protein does not change due to treatment with the fatty acids ( $n=7$ ). C) PA tends to increase the ratio of p-eIF2 $\alpha$ (S51):total eIF2 $\alpha$  protein, and co-treatment with DHA does not prevent the response ( $p=0.077$ ,  $n=7$ ). D) Co-treatment with DHA antagonizes the palmitate-induced increase in Nrf2 protein (\* $p<0.01$  versus all other groups,  $n=3$ ). Representative western blots show phospho-eIF2 $\alpha$ , total eIF2 $\alpha$ , and Nrf2 proteins.

rather than death of multinucleated myotubes. An important part of the UPR transition is the enhancement of ATF4 mRNA and preferential increase in the translation of ATF4 by phosphorylated eIF2 $\alpha$  [135]. As predicted, palmitate increased ATF4 mRNA by over 2-fold and DHA prevented the response (**Fig. 4.3A**). The transcription factor CHOP is a downstream target of ATF4 as well as the other two arms of the UPR, and its transcription indicates severe and/or prolonged ER stress [149]. Palmitate robustly and significantly increased the levels of CHOP mRNA (**Fig. 4.3B**) and protein (**Fig. 4.3C**), while co-treatment with DHA completely prevented the responses (**Fig. 4.3B, C**). Since the basal expression level of CHOP is very low under non-stress conditions [150], it was not unexpected that CHOP protein was undetectable in the control or DHA-treated cells, even after overexposing the films for an extended period of time (**Fig. 4.3C**).

To test whether other arms of the UPR upstream of CHOP were also activated by palmitate, we measured the level of the spliced mRNA that encodes the transcription factor X-box binding protein 1 (XBP1). The amount of spliced XBP1 mRNA (XBP1s) represents an integrated readout of the ATF6 and IRE1 $\alpha$  pathways because XBP1 expression is induced by ATF6 and the spliced form is generated by the endonuclease activity of IRE1 $\alpha$  [123, 124]. PA significantly increased XBP1s mRNA by almost 3-fold, and importantly, co-treatment with DHA prevented the increase (**Fig. 4.4**).

Induction of CHOP signaling can result in several outcomes including activation of caspase-3. Like CHOP, cleaved (i.e. activated) caspase-3 is normally expressed at a low level in the absence of cell stress. As predicted, cleaved caspase-3 was undetectable in the control and DHA-treated samples, whereas palmitate-induced a significant increase in caspase-3 cleavage and DHA attenuated the response (**Fig. 4.5**). Increased ATF4/CHOP

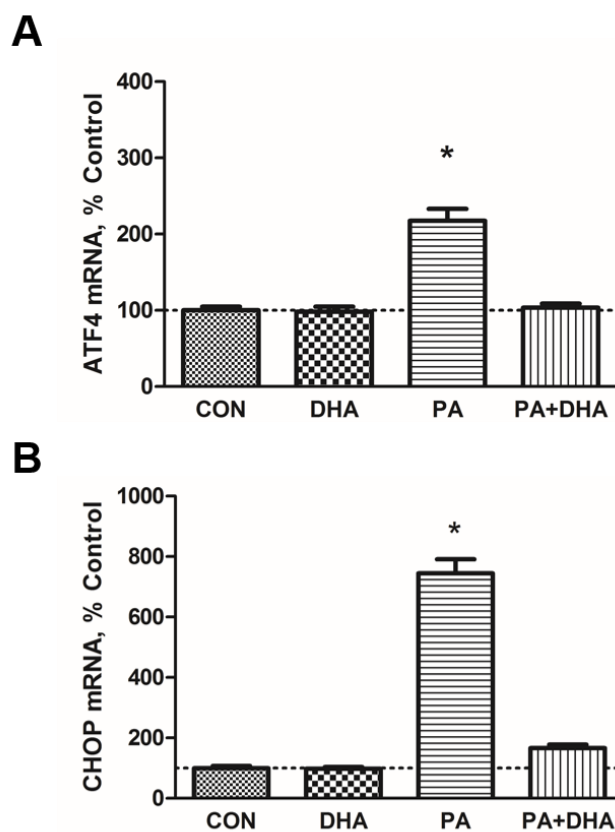

**Figure 4.3. Co-treatment with DHA antagonizes the palmitate-induced increase in ATF4/CHOP signaling.** A) Palmitate (PA) increases ATF4 mRNA (\* $p < 0.0001$  versus all other groups,  $n = 4$ ) and B) CHOP mRNA (\* $p < 0.0001$  versus all other groups,  $n = 4$ ), while co-treatment with DHA prevents the responses. C) Co-treatment with DHA (P+D) antagonizes the PA-induced increase in CHOP protein ( $p < 0.05$ ). The western blot is representative of results from 4 independent experiments. Some cells were treated with 1  $\mu\text{mol/L}$  thapsigargin (Thap) as a positive control.



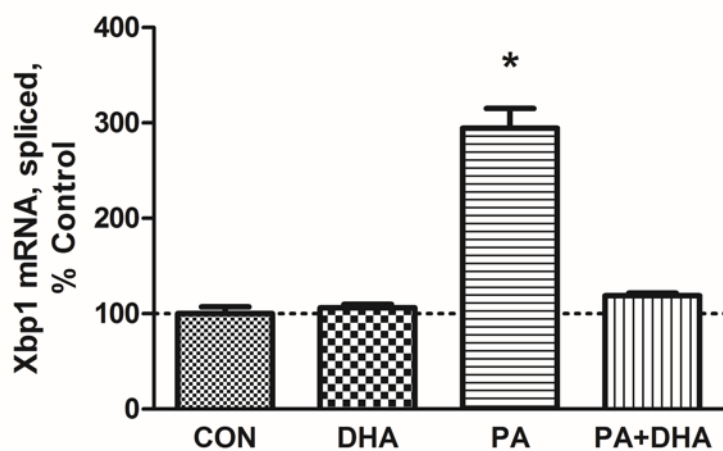

*Figure 4.4. DHA prevents palmitate-induced activation of other UPR arms.*

Palmitate increases mRNA encoding Xbp1s, while co-treatment with DHA (PA+DHA) prevents the response (\* $p < 0.01$  versus all other groups,  $n=4$ ).

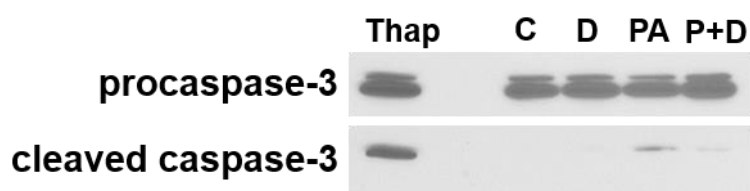
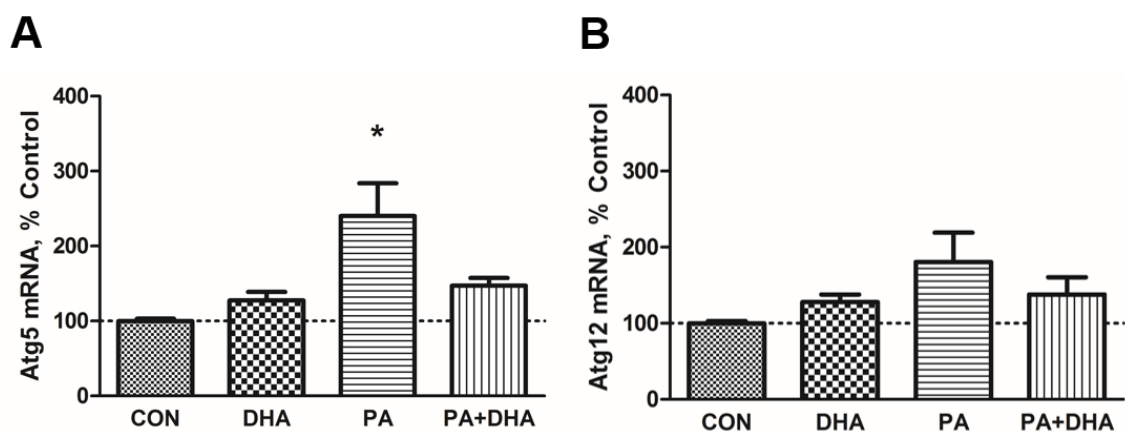

**Figure 4.5.** *Co-treatment with DHA prevents ER stress-related caspase-3 activation induced by palmitate.* PA increases the level of cleaved caspase-3 protein, while co-treatment with DHA (P+D) prevents the response ( $p < 0.05$ ). The western blot is representative of results from 4 independent experiments; the bottom panel showing cleaved caspase-3 was exposed for a longer period of time than the top panel showing procaspase-3. Some cells were treated with 1  $\mu\text{mol/L}$  thapsigargin (Thap) as a positive control.

signaling also has been linked to increases in the transcription of the autophagy genes Atg5 and Atg12 in some cell types [127]. Therefore, we measured Atg5 and Atg12 mRNAs to determine if palmitate-induced ER stress increases transcription of these gene targets in myotubes. Atg5 mRNA was increased 1.7-fold by palmitate and was normalized by co-treatment with DHA (**Fig. 4.6**). The expression pattern of Atg12 was similar to Atg5 in that there was a trend for palmitate to increase Atg12 mRNA and DHA plus palmitate was lower than palmitate alone; however, these changes did not reach statistical significance (**Fig. 4.7**).

## **DISCUSSION**

The ER is responsible for folding, processing, trafficking, and quality control of proteins. In response to stress, it can both suppress the synthesis of nascent proteins and activate the ubiquitin-proteasome and autophagy-lysosome systems to remove damaged proteins and organelles. UPR signals can also result in mitochondrial instability and activation of caspase-mediated proteolysis [115, 117]. These three proteolytic systems are well-documented to be largely responsible for the loss of muscle mass during chronic illness. We recently reported that palmitate reduces the diameter of C2C12 myotubes and increases their rate of protein degradation, at least in part, by reducing Akt activity and consequently, the upregulation of the ubiquitin-proteasome and autophagy-lysosome systems [259]. Importantly, DHA in those studies fully restored Akt signaling and the overall rate of protein degradation. We have now extended our previous findings by confirming that palmitate induces ER stress and caspase-3-mediated proteolysis. We also present evidence that DHA prevents the detrimental effects of palmitate on ER and



**Figure 4.6. ER stress enhances autophagy-related signaling in myotubes.** A) Palmitate increases Atg5 mRNA, while co-treatment with DHA prevents the response (\* $p < 0.01$  versus all other groups,  $n=6$ ). B) The pattern of changes in Atg12 mRNA are similar to Atg5 but do not reach statistical significance ( $n=6$ ).

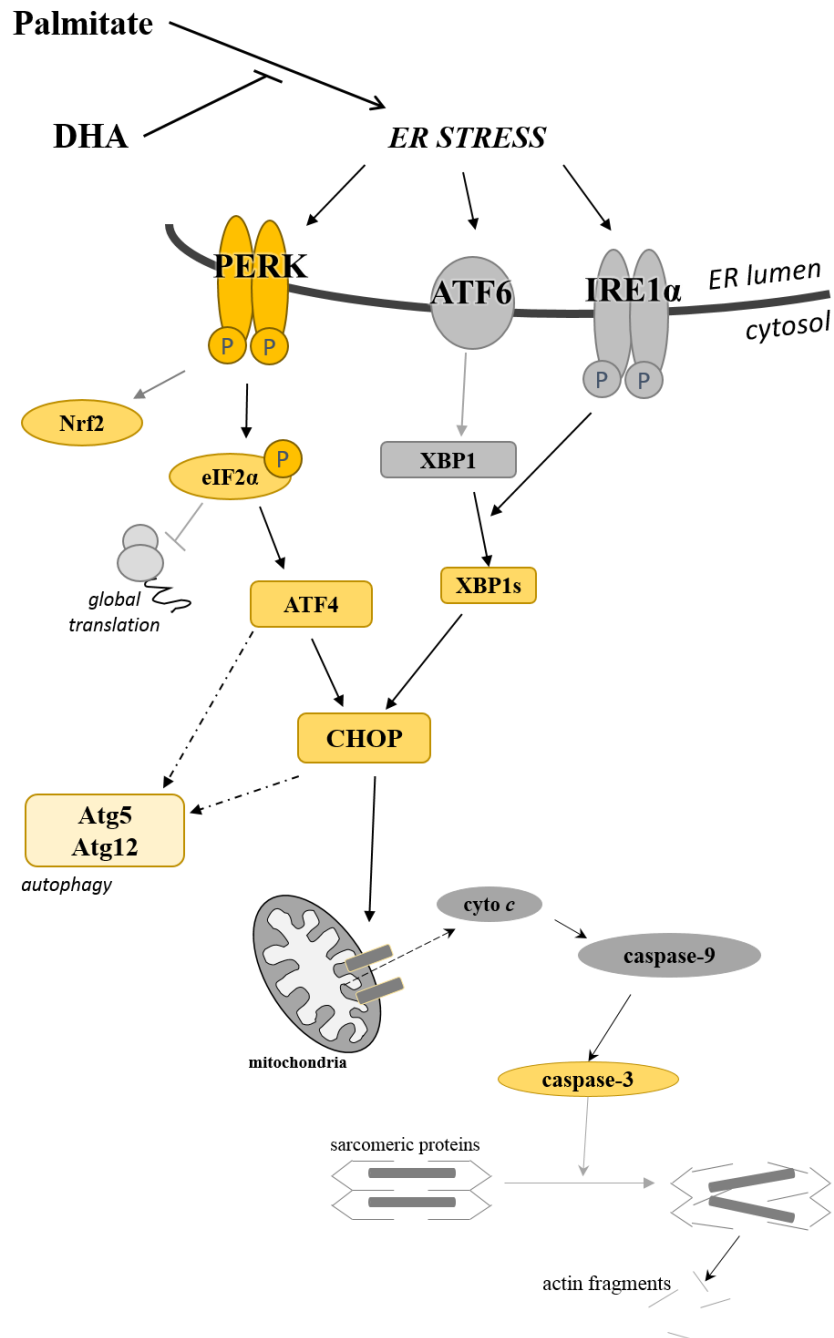

**Figure 4.7. ER stress pathways participate in the regulation of muscle protein homeostasis by palmitate and DHA.** Palmitate induces ER stress and activates the unfolded protein response, resulting in activation of caspase-3. DHA counteracts the effects of palmitate by reducing ER stress, thus antagonizing the increase in UPR mRNAs and proteins and preventing caspase-3 cleavage.

caspase-mediated cell stress pathways in cultured myotubes (**Fig. 4.7**). To our knowledge, this is the first study to demonstrate this protective role of DHA on these pathways in skeletal muscle.

Consistent with a previous report [34], palmitate potently activates the PERK-eIF2 $\alpha$  pathway in our C2C12 myotube model. Phosphorylation of eIF2 $\alpha$  inhibits its activity and decreases the global rate of protein synthesis while preferentially inducing translation of a subset of proteins involved in the stress response. While co-treatment with DHA attenuated the activation of PERK by palmitate, it did not reverse the inhibition of eIF2 $\alpha$ . This could be because the phospho:total PERK ratio in co-treated cells remained at a functionally elevated level despite being unchanged from control cells. Another possible explanation is that palmitate also activates one or more of the three other kinases that phosphorylate eIF2 $\alpha$  on serine 51 and that DHA does not prevent the response. Consistent with this alternative mechanism, the co-addition of DHA and palmitate restores Nrf2 protein to control levels, suggesting that the small remaining increase in PERK activity is not sufficient to drive downstream signaling events.

The eIF2 $\alpha$ -ATF4 axis is referred to as the integrated stress response because it integrates signaling from multiple upstream kinases [133]. Phospho-eIF2 $\alpha$  preferentially increases both ATF4 mRNA and protein [135, 262], and an increase in ATF4 translation is dependent upon the increase in its transcript level [263]. Expression of a non-phosphorylatable mutant of eIF2 $\alpha$  prevents the increase in ATF4 mRNA and the loss of myofiber size in response to fasting in muscle, suggesting that the integrated stress response is required for muscle atrophy under these conditions [163]. We found that palmitate increased ATF4 mRNA by over 200% and that DHA prevented the response.

The ATF4 gene encodes a bZIP transcription factor that targets multiple gene targets; notably, in response to severe or prolonged ER stress, ATF4 is essential for the increase in the mRNA encoding CHOP [133, 136]. The CHOP promoter also contains binding sites for ATF6 and XBP1s, and all three ER stress sensing pathways are required for full CHOP activation [149]. It has been reported that the ATF6-mediated increase in XBP1 mRNA expression is required for IRE1 $\alpha$ -mediated generation of XBP1s [123]. Considering the low expression of XBP1 mRNA in unstressed cells [129], this highlights an important integration of the ATF6 and IRE1 $\alpha$  arms of the UPR. Palmitate robustly increases XBP1s mRNA, suggesting that both the IRE1 $\alpha$  and ATF6 pathways are also activated by the saturated fatty acid. Notably, DHA restored the level of XBP1s mRNA indicating that DHA affects all three arms of the UPR. This is also reflected by the finding that co-treatment with DHA prevents the over 700% increase in CHOP mRNA induced by palmitate alone.

It is interesting that DHA does not prevent the palmitate-induced inactivation of eIF2 $\alpha$  but does abrogate the effects on the other UPR markers. Importantly, Dey and colleagues [263] showed that the integrated stress response through phospho-eIF2 $\alpha$  may or may not increase ATF4, depending on the stress stimulus. They hypothesize that the phosphorylation of eIF2 $\alpha$  is a survival mechanism, and under certain conditions ATF4 can either mediate adaptive or maladaptive responses depending on whether it induces the expression of survival-related genes or CHOP, respectively [263]. This is supported by the finding that reactivation (i.e. dephosphorylation) of eIF2 $\alpha$  and increased global protein synthesis, when it occurs prior to the resolution of ER stress, causes cell death [154]. Our results suggest that palmitate induces ER and other stress that stimulates the

integrated stress response and the phosphorylation of eIF2 $\alpha$ , perhaps through multiple kinases, while co-treatment with DHA prevents ER stress signaling through multiple UPR arms. As such, continual ER stress and phosphorylation of eIF2 $\alpha$  results in a maladaptive response in the palmitate-treated cells, while abrogation of ER stress results in a survival response in the cells co-treated with palmitate and DHA.

ER-associated protein degradation (ERAD) also appears to be involved in the stress response to palmitate. Nrf2 serves as an important mediator of ERAD by increasing the expression of several proteasome subunits [139], thus the palmitate-induced increase in Nrf2 protein is consistent with stimulation of the ubiquitin-proteasome system. In addition, we also found evidence that palmitate induces autophagy. In the present work, palmitate increases Atg5 (and perhaps Atg12) which are involved in the lipidation of microtubule-associated protein light chain 3 (LC3), a critical step in autophagosome formation [91]. These changes were prevented by co-addition of DHA, thus these results extend our earlier finding that DHA decreases the overall level of lipidated LC3. Furthermore, palmitate increased Bnip3 mRNA in our previous study and DHA also restored the mRNA to its control level. Together these data support and build upon our previous study by showing that ER stress is involved in the regulation of the ubiquitin-proteasome and autophagy proteolytic systems in response to fatty acids in myotubes.

An important role of the ER is to sense and transmit signals to the mitochondria [112, 113], and ER dysfunction can result in activation of caspase-3. ER stress-induced CHOP expression can reduce mitochondrial membrane stability by decreasing expression of anti-apoptotic Bcl2 and increasing translocation of pro-apoptotic Bax to the mitochondria in some nonmuscle cell types [142]. CHOP deficient mice have attenuated cardiac



caspase-3 activation and TUNEL-positive nuclei compared to wild type mice in response to pressure overload [158]. Presently, we found that palmitate induces caspase-3 cleavage in myotubes and that co-treatment with DHA prevents the response. Our results suggest that CHOP plays a role in the activation of caspase-3. These results are correlative and we cannot rule out the contribution of other pathways. Akt can regulate caspase-3 by inhibiting the activation of pro-apoptotic proteins Bad [89] and Bax [104]. Our prior results indicated that treating myotubes with palmitate results in a continual suppression of Akt activation over 2-24 hours, while co-treatment with DHA prevented these responses [259]. Therefore, it is possible that the Akt and ER stress signals act cooperatively to regulate mitochondrial function and activation of caspase-mediated proteolysis.

In summary, these data demonstrate that ER stress contributes to the palmitate-induced myotube atrophy. ER stress pathways promote a decrease in muscle protein in response to palmitate by increasing caspase-associated protein degradation and perhaps ER-associated proteasome-mediated proteolysis as well. Importantly, these data indicate that co-treatment with DHA prevents the deleterious effects of palmitate on the ER and resulting activation of caspase-3, suggesting that this omega-3 polyunsaturated fatty acid prevents myotube atrophy by restoring normal signaling through multiple pathways. Since chronic illness-associated muscle atrophy results from activation of multiple proteolytic systems, these results, together with our previous findings, establish a rationale for future studies testing the hypothesis that DHA prevents loss of muscle protein in other models of atrophy.

**CHAPTER 5**  
**DISCUSSION AND CONCLUSIONS**

Skeletal muscle atrophy contributes to a debilitating loss of functional independence and increases the risk of mortality in individuals with numerous chronic illnesses, including T2DM, renal and heart failure, and cancer [247]. Currently there are few effective treatments that counteract the loss of muscle protein in these conditions [248]. Daily protein turnover is highly dynamic such that even small persistent changes in the balance between protein synthesis and protein degradation pathways can significantly impact muscle mass [48]. The loss of muscle protein during chronic illness is primarily due to an accelerated rate of protein degradation mediated by the ubiquitin-proteasome, autophagy-lysosome, and caspase proteolytic systems. Therefore, treatments targeting pathways that regulate all three systems may reduce the loss of muscle protein during chronic illness.

#### **FATTY ACIDS AFFECT MUSCLE PROTEIN BALANCE**

The concentration and composition of circulating, membrane, and intramyocellular lipids influence metabolic pathways and impact protein homeostasis in muscle. In obesity and T2DM, there is an increase in fatty acid transport and accumulation of saturated lipids in skeletal muscle that causes changes in signaling pathways linked to muscle atrophy [59, 198, 203]. This scenario can be recapitulated *in vitro* by treating cultured myotubes with the saturated fatty acid palmitate, which induces a significant decrease in myotube diameter after 48 hours of treatment [33]. Using this cultured myotube model, we show that the palmitate-induced decrease in cell size is due at least in part to an increase in the rate of protein degradation that begins well before the measurable decrease in myotube diameter. Since a few studies suggest that omega-3 PUFAs may

improve protein metabolism in skeletal muscle [25, 27, 37, 38, 229], their supplementation may confer a protective effect during atrophy-inducing conditions. Notably, in cultured myotubes treated with palmitate for 48 hours, co-addition of the  $\omega$ -3 DHA abrogated the palmitate-induced decrease in myotube diameter [33]. Current results demonstrate that the protective effect of DHA is at least in part mediated by restoration of protein degradation to a rate similar to control cells. Since the ubiquitin-proteasome, autophagy-lysosome, and caspase proteolytic systems all contribute to the accelerated rate of overall protein degradation in chronic illness, we hypothesized that their activation underlies the wasting response to palmitate and that co-treatment with DHA counters the response by limiting the induction of proteolytic pathways by palmitate (**Fig. 5.1**). These are the first studies to establish this protective role of DHA in skeletal muscle.

#### **AKT/FOXO SIGNALING AND ER STRESS COLLABORATIVELY REGULATE PROTEOLYSIS IN MYOTUBES**

The Akt/FoxO axis represents a central mechanism for the coordinated regulation of proteasomal, autophagic, and caspase-mediated proteolysis in atrophying skeletal muscle. Data described in this dissertation show that derepression of FoxO through inhibition of Akt by palmitate results in activation of proteasomal proteolysis via FoxO-mediated upregulation of the E3 ligase atrogin-1 and of autophagy via the FoxO-mediated increase in Bnip3. Importantly, co-administration of DHA prevents the increase in palmitate-induced proteolytic activity in part by restoring Akt activity and inhibiting FoxO3. Palmitate also tended to increase LC3 lipidation, which is consistent with an increase in

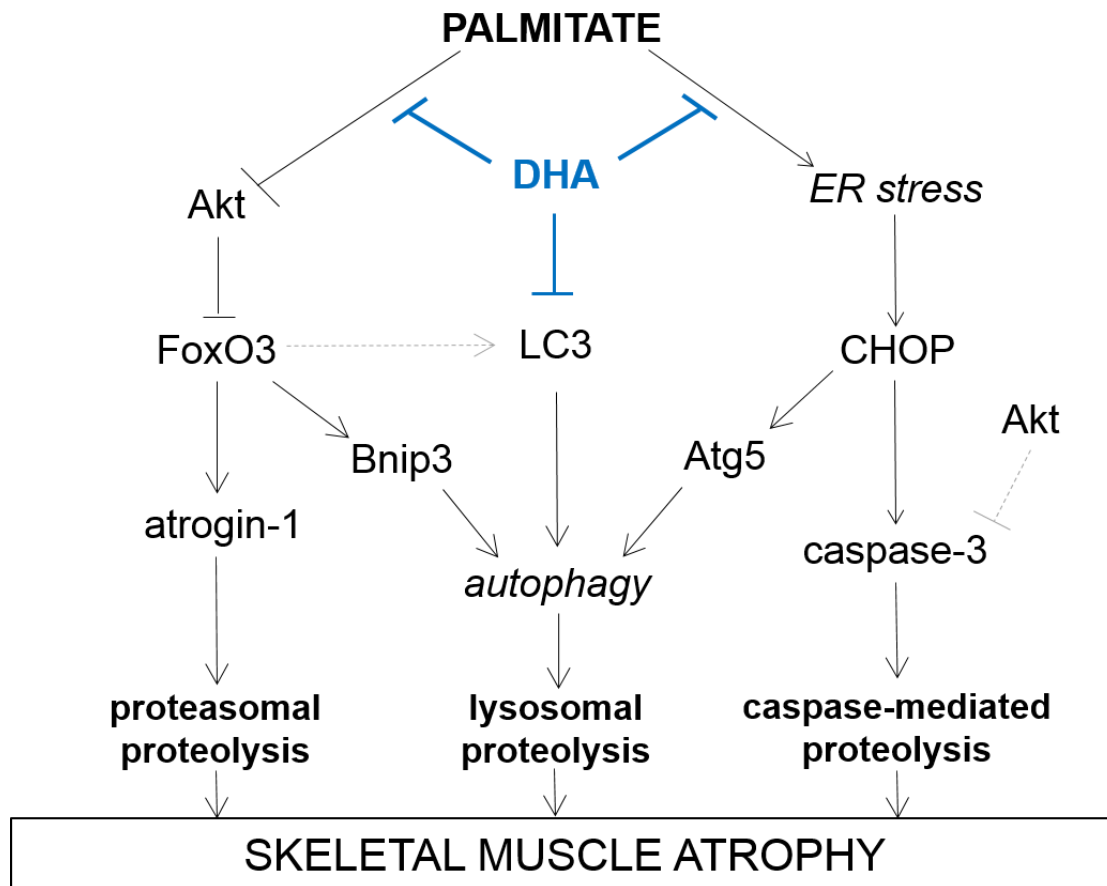

*Figure 5.1. DHA limits the induction of multiple proteolytic pathways by palmitate.* DHA prevents the palmitate-induced suppression of Akt and upregulation of FoxO-mediated expression of atrogenes involved in the ubiquitin-proteasome and autophagy-lysosome systems. DHA also prevents palmitate-induced ER stress and the resulting increase in autophagy-lysosome and caspase-mediated proteolysis.

autophagosome formation as suggested by enhanced Atg5 expression. Interestingly, DHA exerted an independent inhibitory effect on LC3 lipidation. No other measured outcomes were altered in myotubes treated with DHA alone; therefore further examination of this response is needed to identify the mechanism by which DHA alters this step of autophagy. In cardiomyocytes, the upregulation of Atg5 is required for the removal of damaged mitochondria via mitophagy [264]; this suggests that ER stress may have a role in mediating the atrophy response since Atg5 is reported to be a gene target of the UPR [139]. Accordingly, augmented Atg5 expression is consistent with palmitate increasing markers involved in the early step of autophagosome formation and that DHA prevents all of these responses. Notably, this finding is the first demonstration that palmitate increases Atg5 expression in skeletal muscle cells and we provide evidence that supports an association between increased ATF4/CHOP and Atg5 gene expression in response to palmitate. While additional experiments are required to elucidate whether ATF4 and/or CHOP, or potentially other upstream signals, directly regulate Atg5 gene expression in skeletal muscle, these data indicate that an increase in components of the autophagic machinery are involved in the atrophy response to palmitate and that ER stress contributes to this process.

In addition to its role in mitophagy, Bnip3 has also been shown to induce mitochondrial fragmentation and stimulate the release of cytochrome *c* and other apoptotic factors from the mitochondria in cardiomyocytes [264]. Together with the direct modification of proapoptotic Bcl2 family proteins by Akt [89, 104], this suggests that the Akt/FoxO axis regulates mitochondrial stability by several mechanisms, thus providing multiple points of regulation of caspase-3 activation. The observed increase in

Bnip3 expression is supportive of the role of Akt/FoxO in the regulation of caspase-3 activation in response to palmitate. Since CHOP is considered to be a “master regulator” of ER stress-induced caspase-3 activation [5] via modulation of mitochondrial regulators (e.g. Bcl2, Bad, Bax), the findings that CHOP mRNA and protein are robustly increased by palmitate is compatible with a role for ER stress in palmitate-induced caspase-3 activation. In concordance with the increase in Bnip3 expression, these data suggest that palmitate induces mitochondrial dysfunction, stimulating caspase-mediated proteolysis and removal of the damaged mitochondria via mitophagy. Together with the increase in proteasomal proteolysis and removal of cytoplasmic components via autophagy, these responses would mediate the reduction in myofiber size through degradation of myofibrillar and nonmyofibrillar proteins and organelles. Importantly, these data demonstrate that DHA confers protection from palmitate-induced myotube atrophy by restoring Akt activity and preventing ER stress, thereby suppressing atrogene expression, maintaining mitochondrial stability, and preventing activation of all three proteolytic systems.

## **FUTURE DIRECTIONS**

### *The potential role of protein synthesis in palmitate-induced myotube atrophy*

An accelerated rate of protein degradation is the primary cause of chronic illness-induced muscle atrophy; however, a decreased rate of protein synthesis would also contribute to the net loss of muscle protein. The alterations in cell signaling induced by palmitate could suppress protein synthesis in multiple ways. First, since the

insulin/PI3K/Akt pathway is a critical mediator of protein synthesis in skeletal muscle, suppression of Akt would reduce signaling through mTOR and downstream mediators of the protein synthesis pathway. In this regard, the previous study examining long-term (48-96 hours) treatment of myotubes with palmitate and DHA showed that DHA prevents the palmitate-induced suppression of S6 kinase and ribosomal protein S6, which is suggestive of a restoration of protein synthesis by the omega-3 PUFA [33]. Second, since eIF2 $\alpha$  is the primary regulator of translation initiation, the inhibition of eIF2 $\alpha$  by palmitate is suggestive of a decrease in global protein translation. Direct measurement of the rate of protein synthesis would clarify whether its suppression contributes to the early changes in muscle metabolism induced by palmitate that ultimately lead to a decrease in cell size and whether co-treatment with DHA prevents the response.

*The potential role of oxidative stress in myotube atrophy: differential effects of palmitate and DHA*

One mechanism by which DHA could alleviate palmitate-induced muscle atrophy is by prevention of oxidative stress. While the studies presented in this dissertation did not measure oxidative stress in response to these fatty acids, studies in myotubes and other cell types suggest that palmitate and DHA exert differing effects on the formation of oxidative species and related signaling pathways. Palmitate has been shown to induce the over-production of mitochondrial reactive oxygen species in L6 myotubes [184, 213, 214]. In retinal cells, DHA prevents oxidative stress and the resulting activation of caspase-3 and apoptosis [249, 251], but the effect of DHA on oxidative stress has not been studied in muscle. Nrf2 is a central integrator of the cellular response to oxidative



stress [138, 140] and is required for cell survival during ER stress [137]. Our finding that co-treatment with DHA prevents the palmitate-induced increase in Nrf2 protein is suggestive of a reduction in PERK-mediated Nrf2 activation since phosphorylation of Nrf2 prevents its degradation and increases its total cellular level. Thus the protective effect of DHA in this model may be due to prevention of palmitate-induced oxidative stress. One way that Nrf2 mediates cell survival is by supporting the maintenance of glutathione levels to buffer reactive species generated during the UPR [141]. It has been shown that overexpression of CHOP depletes cellular glutathione levels, while restoration of glutathione in CHOP-overexpressing cells prevents ER stress-induced cell death [142]. In the studies by Yuzefovych et al. [213], preventing the palmitate-induced generation of mitochondrial reactive oxygen species also prevented palmitate-induced cell death. Furthermore, polyphenol-rich compounds such as pomegranate and green tea extracts have been shown to prevent the induction of ER stress, oxidative stress, and protein degradation induced by a high fat diet in skeletal muscle of mice [143]. Together these data suggest that preventing the accumulation of reactive species in multinucleated muscle cells can facilitate adaptation of the cell to ER stress rather than progression to activation of caspase-mediated proteolytic systems and other apoptotic-like responses. The palmitate-induced increase in Bnip3 and Atg5 likely reflects the elimination of damaged mitochondria by mitophagy, perhaps as a consequence of mitochondrial dysfunction and ROS production. While DHA may not be acting as an antioxidant *per se*, it may have the ability to reduce the generation of oxidative species and thus indirectly protect the mitochondria from oxidative damage. The ability of DHA to counteract

myotube atrophy by preventing palmitate-induced oxidative stress is an interesting hypothesis to test in future studies.

*DHA may prevent disruption of ER calcium homeostasis*

Calcium release from the ER is an important modulator of apoptotic pathways initiated by various stimuli, including ER stress, oxidative stress, and lipid second messengers [155]. Leakage of calcium from the ER through the inositol-1,4,5-triphosphate (IP<sub>3</sub>) receptors can lead to overproduction of mitochondrial reactive oxygen species through several mechanisms, resulting in opening of the mitochondrial permeability transition pore and the release of cytochrome *c* into the cytosol and activation of other apoptosis-inducing factors. Prolonged generation of mitochondrial reactive oxygen species can sustain this cycle by causing additional receptor-mediated ER calcium release and further damages to the mitochondria [5].

A potential mechanism by which DHA may prevent ER and oxidative stress is through the maintenance of ER calcium homeostasis. Intraperitoneal injection of DHA for 3-21 days following traumatic brain injury in rats attenuated expression of phospho-eIF2 $\alpha$  and ATF4 and promoted earlier recovery of sensorimotor function. These responses were achieved by inhibition of IP<sub>3</sub>-mediated calcium release from the ER [219]. SR/ER calcium-ATPase (SERCA) pumps are responsible for moving calcium against its concentration gradient from the cytosol into the ER and thus oppose the action of IP<sub>3</sub> receptor-mediated calcium release [218]. One study shows a positive association between DHA content and SR/mitochondrial volume density in skeletal muscle, and the authors hypothesized that the enrichment of SR and mitochondrial phospholipids with

DHA is needed for proper SERCA and mitochondrial oxidative function, respectively [44]. This hypothesis is supported by the observations that SERCA comprises approximately 90% of total SR protein in fully-differentiated skeletal muscle [265] and that the most abundant phospholipid species in rat skeletal muscle SR and mitochondria contain DHA [266]. Additionally, supplementation with DHA, but not EPA, effectively increases the DHA-containing phospholipid content of mitochondrial membranes and delays opening of the calcium-induced mitochondrial permeability transition pore in both normal and hypertrophied myocardium [221]. Therefore, it is tempting to hypothesize that enrichment of muscle DHA may confer a protective effect against stress-induced caspase-3 activation via maintenance of ER calcium homeostasis and prevention of mitochondrial oxidative stress, potentially via regulation of calcium release from and/or calcium uptake into the SR or preservation of mitochondrial membrane stability.

*Palmitate and DHA may differentially alter microRNA expression*

Lastly, another mechanism by which DHA may protect myotubes from the detrimental effects of palmitate is through alterations in microRNA (miR) expression. In enteric neurons, palmitate increases miR-375 and causes ER stress and mitochondrial dysfunction, resulting in activation of caspase-3 [267]. The targeted inhibition of miR-375 prevents palmitate-induced caspase-3 cleavage, and this response may be due to maintenance of survival signaling via PDK1-mediated Akt phosphorylation, since overexpression of miR-375 reduces the level PDK1 protein [267]. Our finding that DHA prevents the palmitate-induced suppression of Akt activation and cleavage of caspase-3 is consistent with this hypothesis. Additionally, palmitate induces apoptosis in

cardiomyocytes by upregulating miR-195 which targets Bcl2 and Sirtuin 1 (SIRT1) [216]. In response to oxidative stress, SIRT1 has been shown to bind to and deacetylate FoxO3, which increases its resistance to oxidative stress and decreases its death-inducing capability [268]. SIRT1 also deacetylates and activates PPAR  $\gamma$  coactivator 1  $\alpha$  (PGC1 $\alpha$ ), an important regulator of mitochondrial biogenesis and fatty acid oxidation in myotubes [269], and chemical activation of SIRT1 prevents insulin resistance caused by diet-induced-obesity [270]. It is currently unknown if palmitate increases miR-195 in skeletal muscle cells, but it has been shown that DHA increases SIRT1 in macrophages [271] and vascular endothelial cells [272]. Therefore, it is plausible that DHA could prevent palmitate-induced alterations in miR-195, which may maintain the level of Bcl2 protein and promote SIRT1 and PGC1 $\alpha$  activity. Our finding that the increase in FoxO3 atrogenic targets is ameliorated by co-administration of DHA is consistent with these prospective mechanisms. Therefore, the differential modification of these or other microRNAs by palmitate and DHA may contribute to their opposing effects on myotube atrophy. The regulation of microRNA levels in skeletal muscle by fatty acids is an interesting emerging area of research.

## CONCLUSIONS

Skeletal muscle atrophy affects a broad range of individuals and has a substantial negative impact on overall health. Despite this, there are currently few effective treatments to counteract the loss of muscle mass in chronic illnesses and other conditions. Targeted treatments such as proteasome inhibitors have been largely ineffective at maintaining muscle mass suggesting that ideal therapies would affect multiple proteolytic

systems. In our *in vitro* model system, DHA exerts beneficial effects on pathways that are commonly dysregulated in conditions associated with muscle atrophy, including insulin-Akt and ER-mediated signaling; these pathways regulate multiple proteolytic systems that act in concert to accelerate the degradation of muscle proteins during chronic illness. The studies described in this dissertation are the first to directly investigate the effects of a single  $\omega$ -3 PUFA on pathways regulating protein catabolism in muscle cells. The data demonstrate that DHA effectively prevents the enhancement in all three proteolytic systems. An interesting next step will be to test whether DHA exerts similar protective effects in animals subjected to atrophy-inducing stimuli, such as high fat feeding. The results also warrant further investigation into the potential therapeutic application of this  $\omega$ -3 fatty acid in counteracting muscle loss due to chronic illness.

## REFERENCES

1. Srikanthan, P. and A.S. Karlamangla, *Muscle mass index as a predictor of longevity in older adults*. Am J Med, 2014. **127**(6): p. 547-53.
2. Wolfe, R.R., *The underappreciated role of muscle in health and disease*. Am J Clin Nutr, 2006. **84**(3): p. 475-82.
3. Taylor, S.I., D. Accili, and Y. Imai, *Insulin resistance or insulin deficiency. Which is the primary cause of NIDDM?* Diabetes, 1994. **43**(6): p. 735-40.
4. Logue, S.E., et al., *New directions in ER stress-induced cell death*. Apoptosis, 2013. **18**(5): p. 537-46.
5. Cao, S.S. and R.J. Kaufman, *Endoplasmic reticulum stress and oxidative stress in cell fate decision and human disease*. Antioxid Redox Signal, 2014. **21**(3): p. 396-413.
6. Inagi, R., Y. Ishimoto, and M. Nangaku, *Proteostasis in endoplasmic reticulum-new mechanisms in kidney disease*. Nat Rev Nephrol, 2014.
7. Laybutt, D.R., et al., *Endoplasmic reticulum stress contributes to beta cell apoptosis in type 2 diabetes*. Diabetologia, 2007. **50**(4): p. 752-63.
8. Deldicque, L., *Endoplasmic reticulum stress in human skeletal muscle: any contribution to sarcopenia?* Front Physiol, 2013. **4**: p. 236.
9. Schrauwen, P., *High-fat diet, muscular lipotoxicity and insulin resistance*. Proc Nutr Soc, 2007. **66**(1): p. 33-41.
10. Kovacs, P. and M. Stumvoll, *Fatty acids and insulin resistance in muscle and liver*. Best Pract Res Clin Endocrinol Metab, 2005. **19**(4): p. 625-35.
11. Huang, T., et al., *Increased plasma n-3 polyunsaturated fatty acid is associated with improved insulin sensitivity in type 2 diabetes in China*. Mol Nutr Food Res, 2010. **54 Suppl 1**: p. S112-9.
12. Borkman, M., et al., *The relation between insulin sensitivity and the fatty-acid composition of skeletal-muscle phospholipids*. N Engl J Med, 1993. **328**(4): p. 238-44.
13. Popp-Snijders, C., et al., *Dietary supplementation of omega-3 polyunsaturated fatty acids improves insulin sensitivity in non-insulin-dependent diabetes*. Diabetes Res, 1987. **4**(3): p. 141-7.
14. German, J.B. and C.J. Dillard, *Saturated fats: what dietary intake?* Am J Clin Nutr, 2004. **80**(3): p. 550-9.
15. Wijendran V, H.K.C., *Dietary n-6 and n-3 fatty acid balance and cardiovascular health*. Annu Rev Nutr, 2004. **24**:**597-615**;0(0): p. 0.
16. Khaw, K.T., et al., *Plasma phospholipid fatty acid concentration and incident coronary heart disease in men and women: the EPIC-Norfolk prospective study*. PLoS Med, 2012. **9**(7): p. e1001255.
17. Wang, C., et al., *n-3 Fatty acids from fish or fish-oil supplements, but not alpha-linolenic acid, benefit cardiovascular disease outcomes in primary- and secondary-prevention studies: a systematic review*. Am J Clin Nutr, 2006. **84**(1): p. 5-17.

18. Williams, C.M. and G. Burdge, *Long-chain n-3 PUFA: plant v. marine sources*. Proc Nutr Soc, 2006. **65**(1): p. 42-50.
19. Steffen, B.T., et al., *n-3 and n-6 Fatty acids are independently associated with lipoprotein-associated phospholipase A2 in the Multi-Ethnic Study of Atherosclerosis*. Br J Nutr, 2013. **110**(9): p. 1664-71.
20. Storlien, L.H., et al., *Influence of dietary fat composition on development of insulin resistance in rats. Relationship to muscle triglyceride and omega-3 fatty acids in muscle phospholipid*. Diabetes, 1991. **40**(2): p. 280-9.
21. Storlien, L.H., et al., *Fish oil prevents insulin resistance induced by high-fat feeding in rats*. Science, 1987. **237**(4817): p. 885-8.
22. Andersson, A., et al., *Fatty acid composition of skeletal muscle reflects dietary fat composition in humans*. Am J Clin Nutr, 2002. **76**(6): p. 1222-9.
23. Taouis, M., et al., *N-3 polyunsaturated fatty acids prevent the defect of insulin receptor signaling in muscle*. Am J Physiol Endocrinol Metab, 2002. **282**(3): p. E664-71.
24. Timmers, S., et al., *Differential effects of saturated versus unsaturated dietary fatty acids on weight gain and myocellular lipid profiles in mice*. Nutr Diabetes, 2011. **1**: p. e11.
25. Liu, Y., et al., *Fish oil increases muscle protein mass and modulates Akt/FOXO, TLR4, and NOD signaling in weanling piglets after lipopolysaccharide challenge*. J Nutr, 2013. **143**(8): p. 1331-9.
26. D'Alessandro, M.E., Y.B. Lombardo, and A. Chicco, *Effect of dietary fish oil on insulin sensitivity and metabolic fate of glucose in the skeletal muscle of normal rats*. Ann Nutr Metab, 2002. **46**(3-4): p. 114-20.
27. Gingras, A.A., et al., *Long-chain omega-3 fatty acids regulate bovine whole-body protein metabolism by promoting muscle insulin signalling to the Akt-mTOR-S6K1 pathway and insulin sensitivity*. J Physiol, 2007. **579**(Pt 1): p. 269-84.
28. Rossi, A.S., et al., *Dietary fish oil positively regulates plasma leptin and adiponectin levels in sucrose-fed, insulin-resistant rats*. Am J Physiol Regul Integr Comp Physiol, 2005. **289**(2): p. R486-R494.
29. Mustad, V.A., et al., *Differential effects of n-3 polyunsaturated fatty acids on metabolic control and vascular reactivity in the type 2 diabetic ob/ob mouse*. Metabolism, 2006. **55**(10): p. 1365-74.
30. Lombardo, Y.B., G. Hein, and A. Chicco, *Metabolic syndrome: effects of n-3 PUFAs on a model of dyslipidemia, insulin resistance and adiposity*. Lipids, 2007. **42**(5): p. 427-37.
31. Andersen, G., et al., *Dietary eicosapentaenoic acid and docosahexaenoic acid are more effective than alpha-linolenic acid in improving insulin sensitivity in rats*. Ann Nutr Metab, 2008. **52**(3): p. 250-6.
32. Aas, V., et al., *Eicosapentaenoic acid (20:5 n-3) increases fatty acid and glucose uptake in cultured human skeletal muscle cells*. J Lipid Res, 2006. **47**(2): p. 366-74.
33. Bryner, R.W., et al., *Docosahexaenoic Acid protects muscle cells from palmitate-induced atrophy*. ISRN Obes, 2012. **2012**: p. 647348.

34. Deldicque, L., et al., *The unfolded protein response is activated in skeletal muscle by high-fat feeding: potential role in the downregulation of protein synthesis*. Am J Physiol Endocrinol Metab, 2010. **299**(5): p. E695-705.
35. Lee, J.S., et al., *Saturated, but not n-6 polyunsaturated, fatty acids induce insulin resistance: role of intramuscular accumulation of lipid metabolites*. J Appl Physiol (1985), 2006. **100**(5): p. 1467-74.
36. Montell, E., et al., *DAG accumulation from saturated fatty acids desensitizes insulin stimulation of glucose uptake in muscle cells*. Am J Physiol Endocrinol Metab, 2001. **280**(2): p. E229-37.
37. You, J.S., et al., *Dietary fish oil alleviates soleus atrophy during immobilization in association with Akt signaling to p70s6k and E3 ubiquitin ligases in rats*. Appl Physiol Nutr Metab, 2010. **35**(3): p. 310-8.
38. Gladman, S.J., et al., *Improved outcome after peripheral nerve injury in mice with increased levels of endogenous omega-3 polyunsaturated fatty acids*. J Neurosci, 2012. **32**(2): p. 563-71.
39. Barber, M.D., et al., *The effect of an oral nutritional supplement enriched with fish oil on weight-loss in patients with pancreatic cancer*. Br J Cancer, 1999. **81**(1): p. 80-6.
40. Burdge, G.C. and P.C. Calder, *Conversion of alpha-linolenic acid to longer-chain polyunsaturated fatty acids in human adults*. Reprod Nutr Dev, 2005. **45**(5): p. 581-97.
41. Brenna, J.T., et al., *alpha-Linolenic acid supplementation and conversion to n-3 long-chain polyunsaturated fatty acids in humans*. Prostaglandins Leukot Essent Fatty Acids, 2009. **80**(2-3): p. 85-91.
42. Innis, S.M., *Essential fatty acid requirements in human nutrition*. Can J Physiol Pharmacol, 1993. **71**(9): p. 699-706.
43. Conquer, J.A. and B.J. Holub, *Effect of supplementation with different doses of DHA on the levels of circulating DHA as non-esterified fatty acid in subjects of Asian Indian background*. J Lipid Res, 1998. **39**(2): p. 286-92.
44. Infante, J.P., R.C. Kirwan, and J.T. Brenna, *High levels of docosahexaenoic acid (22:6n-3)-containing phospholipids in high-frequency contraction muscles of hummingbirds and rattlesnakes*. Comp Biochem Physiol B Biochem Mol Biol, 2001. **130**(3): p. 291-8.
45. Mitch, W.E. and A.L. Goldberg, *Mechanisms of muscle wasting. The role of the ubiquitin-proteasome pathway*. N Engl J Med, 1996. **335**(25): p. 1897-905.
46. Brooks, S.V., *Current topics for teaching skeletal muscle physiology*. Adv Physiol Educ, 2003. **27**(1-4): p. 171-82.
47. Goll, D.E., et al., *Myofibrillar protein turnover: the proteasome and the calpains*. J Anim Sci, 2008. **86**(14 Suppl): p. E19-35.
48. Franch, H.A. and S.R. Price, *Molecular signaling pathways regulating muscle proteolysis during atrophy*. Curr Opin Clin Nutr Metab Care, 2005. **8**(3): p. 271-5.
49. Brooks, N.E. and K.H. Myburgh, *Skeletal muscle wasting with disuse atrophy is multi-dimensional: the response and interaction of myonuclei, satellite cells and signaling pathways*. Front Physiol, 2014. **5**: p. 99.



50. Drenick, E.J., et al., *Prolonged Starvation as Treatment for Severe Obesity*. JAMA, 1964. **187**: p. 100-5.
51. Phillips, D.I., et al., *Intramuscular triglyceride and muscle insulin sensitivity: evidence for a relationship in nondiabetic subjects*. Metabolism, 1996. **45**(8): p. 947-50.
52. Goodpaster, B.H., F.L. Thaete, and D.E. Kelley, *Thigh adipose tissue distribution is associated with insulin resistance in obesity and in type 2 diabetes mellitus*. Am J Clin Nutr, 2000. **71**(4): p. 885-92.
53. Manco, M., et al., *Insulin resistance directly correlates with increased saturated fatty acids in skeletal muscle triglycerides*. Metabolism, 2000. **49**(2): p. 220-4.
54. Siew, E.D., et al., *Insulin resistance is associated with skeletal muscle protein breakdown in non-diabetic chronic hemodialysis patients*. Kidney Int, 2007. **71**(2): p. 146-52.
55. Pupim, L.B., et al., *Increased muscle protein breakdown in chronic hemodialysis patients with type 2 diabetes mellitus*. Kidney Int, 2005. **68**(4): p. 1857-65.
56. *National Diabetes Statistics Report: Estimates of Diabetes and Its Burden in the United States, 2014*. Atlanta, GA: U.S. Department of Health and Human Services; 2014.
57. Pyram, R., et al., *Chronic kidney disease and diabetes*. Maturitas, 2011.
58. Fox, C.S., et al., *Trends in cardiovascular complications of diabetes*. JAMA, 2004. **292**(20): p. 2495-9.
59. Sun, Z., et al., *Muscular response and adaptation to diabetes mellitus*. Front Biosci, 2008. **13**: p. 4765-94.
60. Srikanthan, P. and A.S. Karlamangla, *Relative muscle mass is inversely associated with insulin resistance and prediabetes. Findings from the third National Health and Nutrition Examination Survey*. J Clin Endocrinol Metab, 2011. **96**(9): p. 2898-903.
61. Leenders, M., et al., *Patients with type 2 diabetes show a greater decline in muscle mass, muscle strength, and functional capacity with aging*. J Am Med Dir Assoc, 2013. **14**(8): p. 585-92.
62. Tajiri, Y., et al., *Reduction of skeletal muscle, especially in lower limbs, in Japanese type 2 diabetic patients with insulin resistance and cardiovascular risk factors*. Metab Syndr Relat Disord, 2010. **8**(2): p. 137-42.
63. Park, S.W., et al., *Accelerated loss of skeletal muscle strength in older adults with type 2 diabetes: the health, aging, and body composition study*. Diabetes Care, 2007. **30**(6): p. 1507-12.
64. Cameron, N.E., M.A. Cotter, and S. Robertson, *Changes in skeletal muscle contractile properties in streptozocin-induced diabetic rats and role of polyol pathway and hypoinsulinemia*. Diabetes, 1990. **39**(4): p. 460-5.
65. Aughstee, A.A., A.M. Khair, and A.A. Suleiman, *Quantitative morphometric study of the skeletal muscles of normal and streptozotocin-diabetic rats*. JOP, 2006. **7**(4): p. 382-9.
66. Price, S.R., et al., *Muscle wasting in insulinopenic rats results from activation of the ATP-dependent, ubiquitin-proteasome proteolytic pathway by a mechanism including gene transcription*. J Clin Invest, 1996. **98**(8): p. 1703-8.

67. Lowell, B.B., N.B. Ruderman, and M.N. Goodman, *Evidence that lysosomes are not involved in the degradation of myofibrillar proteins in rat skeletal muscle*. *Biochem J*, 1986. **234**(1): p. 237-40.
68. Rock, K.L., et al., *Inhibitors of the proteasome block the degradation of most cell proteins and the generation of peptides presented on MHC class I molecules*. *Cell*, 1994. **78**(5): p. 761-71.
69. Lecker, S.H., et al., *Muscle protein breakdown and the critical role of the ubiquitin-proteasome pathway in normal and disease states*. *J Nutr*, 1999. **129**(1S Suppl): p. 227S-237S.
70. Lecker, S.H., et al., *Multiple types of skeletal muscle atrophy involve a common program of changes in gene expression*. *The FASEB Journal*, 2004. **18**(1): p. 39-51.
71. Cao, P.R., H.J. Kim, and S.H. Lecker, *Ubiquitin-protein ligases in muscle wasting*. *Int J Biochem Cell Biol*, 2005. **37**(10): p. 2088-97.
72. Deshaies, R.J., *SCF and Cullin/Ring H2-based ubiquitin ligases*. *Annu Rev Cell Dev Biol*, 1999. **15**: p. 435-67.
73. Cardozo, T. and M. Pagano, *The SCF ubiquitin ligase: insights into a molecular machine*. *Nat Rev Mol Cell Biol*, 2004. **5**(9): p. 739-51.
74. Bodine, S.C., et al., *Identification of ubiquitin ligases required for skeletal muscle atrophy*. *Science*, 2001. **294**(5547): p. 1704-8.
75. Gomes, M.D., et al., *Atrogin-1, a muscle-specific F-box protein highly expressed during muscle atrophy*. *Proc Natl Acad Sci U S A*, 2001. **98**(25): p. 14440-5.
76. Jones, S.W., et al., *Disuse atrophy and exercise rehabilitation in humans profoundly affects the expression of genes associated with the regulation of skeletal muscle mass*. *FASEB J*, 2004. **18**(9): p. 1025-7.
77. Csibi, A., et al., *MAFbx/Atrogin-1 controls the activity of the initiation factor eIF3-f in skeletal muscle atrophy by targeting multiple C-terminal lysines*. *J Biol Chem*, 2009. **284**(7): p. 4413-21.
78. Lagirand-Cantaloube, J., et al., *The initiation factor eIF3-f is a major target for atrogin1/MAFbx function in skeletal muscle atrophy*. *EMBO J*, 2008. **27**(8): p. 1266-76.
79. Lagirand-Cantaloube, J., et al., *Inhibition of atrogin-1/MAFbx mediated MyoD proteolysis prevents skeletal muscle atrophy in vivo*. *PLoS One*, 2009. **4**(3): p. e4973.
80. Centner, T., et al., *Identification of muscle specific ring finger proteins as potential regulators of the titin kinase domain*. *J Mol Biol*, 2001. **306**(4): p. 717-26.
81. Cohen, S., et al., *During muscle atrophy, thick, but not thin, filament components are degraded by MuRF1-dependent ubiquitylation*. *J Cell Biol*, 2009. **185**(6): p. 1083-95.
82. Dupont-Versteegden, E.E., *Apoptosis in skeletal muscle and its relevance to atrophy*. *World J Gastroenterol*, 2006. **12**(46): p. 7463-6.
83. Du, J., et al., *Activation of caspase-3 is an initial step triggering accelerated muscle proteolysis in catabolic conditions*. *J Clin Invest*, 2004. **113**(1): p. 115-23.

84. McClung, J.M., et al., *Caspase-3 regulation of diaphragm myonuclear domain during mechanical ventilation-induced atrophy*. Am J Respir Crit Care Med, 2007. **175**(2): p. 150-9.
85. Hao, Y., et al., *beta-Hydroxy-beta-methylbutyrate reduces myonuclear apoptosis during recovery from hind limb suspension-induced muscle fiber atrophy in aged rats*. Am J Physiol Regul Integr Comp Physiol, 2011. **301**(3): p. R701-15.
86. Hu, J., et al., *XIAP reduces muscle proteolysis induced by CKD*. J Am Soc Nephrol, 2010. **21**(7): p. 1174-83.
87. Primeau, A.J., P.J. Adhihetty, and D.A. Hood, *Apoptosis in heart and skeletal muscle*. Can J Appl Physiol, 2002. **27**(4): p. 349-95.
88. Sharpe, J.C., D. Arnoult, and R.J. Youle, *Control of mitochondrial permeability by Bcl-2 family members*. Biochimica et Biophysica Acta, 2004. **1644**(2-3): p. 107-13.
89. Gao, Y., et al., *Regulation of caspase-3 activity by insulin in skeletal muscle cells involves both PI3-kinase and MEK-1/2*. J Appl Physiol (1985), 2008. **105**(6): p. 1772-8.
90. Sandri, M., *New findings of lysosomal proteolysis in skeletal muscle*. Curr Opin Clin Nutr Metab Care, 2011. **14**(3): p. 223-9.
91. Wing, S.S., S.H. Lecker, and R.T. Jagoe, *Proteolysis in illness-associated skeletal muscle atrophy: from pathways to networks*. Crit Rev Clin Lab Sci, 2011. **48**(2): p. 49-70.
92. Bechet, D., et al., *Lysosomal proteolysis in skeletal muscle*. Int J Biochem Cell Biol, 2005. **37**(10): p. 2098-114.
93. Kang, R., et al., *The Beclin 1 network regulates autophagy and apoptosis*. Cell Death Differ, 2011. **18**(4): p. 571-80.
94. Tanida, I., T. Ueno, and E. Kominami, *Human light chain 3/MAP1LC3B is cleaved at its carboxyl-terminal Met121 to expose Gly120 for lipidation and targeting to autophagosomal membranes*. J Biol Chem, 2004. **279**(46): p. 47704-10.
95. Ichimura, Y. and M. Komatsu, *Pathophysiological role of autophagy: lesson from autophagy-deficient mouse models*. Exp Anim, 2011. **60**(4): p. 329-45.
96. Lum, J.J., et al., *Growth factor regulation of autophagy and cell survival in the absence of apoptosis*. Cell, 2005. **120**(2): p. 237-48.
97. Romanello, V., et al., *Mitochondrial fission and remodelling contributes to muscle atrophy*. EMBO J, 2010. **29**(10): p. 1774-85.
98. Zhang, J. and P.A. Ney, *Role of BNIP3 and NIX in cell death, autophagy, and mitophagy*. Cell Death Differ, 2009. **16**(7): p. 939-46.
99. Stitt, T.N., et al., *The IGF-1/PI3K/Akt pathway prevents expression of muscle atrophy-induced ubiquitin ligases by inhibiting FOXO transcription factors*. Mol Cell, 2004. **14**(3): p. 395-403.
100. Rommel, C., et al., *Mediation of IGF-1-induced skeletal myotube hypertrophy by PI(3)K/Akt/mTOR and PI(3)K/Akt/GSK3 pathways*. Nat Cell Biol, 2001. **3**(11): p. 1009-13.
101. Bodine, S.C., et al., *Akt/mTOR pathway is a crucial regulator of skeletal muscle hypertrophy and can prevent muscle atrophy in vivo*. Nat Cell Biol, 2001. **3**(11): p. 1014-9.

102. Bailey, J.L., et al., *Chronic kidney disease causes defects in signaling through the insulin receptor substrate/phosphatidylinositol 3-kinase/Akt pathway: implications for muscle atrophy*. J Am Soc Nephrol, 2006. **17**(5): p. 1388-94.
103. Zheng, B., et al., *FOXO3a mediates signaling crosstalk that coordinates ubiquitin and atrogen-1/MAFbx expression during glucocorticoid-induced skeletal muscle atrophy*. FASEB J, 2010. **24**(8): p. 2660-9.
104. Lee, S.W., et al., *Regulation of muscle protein degradation: coordinated control of apoptotic and ubiquitin-proteasome systems by phosphatidylinositol 3 kinase*. J Am Soc Nephrol, 2004. **15**(6): p. 1537-45.
105. Satchek, J.M., et al., *IGF-I stimulates muscle growth by suppressing protein breakdown and expression of atrophy-related ubiquitin ligases, atrogen-1 and MuRF1*. Am J Physiol Endocrinol Metab, 2004. **287**(4): p. E591-601.
106. Accili, D. and K.C. Arden, *FoxOs at the crossroads of cellular metabolism, differentiation, and transformation*. Cell, 2004. **117**(4): p. 421-6.
107. Mammucari, C., et al., *FoxO3 controls autophagy in skeletal muscle in vivo*. Cell Metabolism, 2007. **6**(6): p. 458-71.
108. Dobson, M., et al., *Bimodal regulation of FoxO3 by AKT and 14-3-3*. Biochim Biophys Acta, 2011. **1813**(8): p. 1453-64.
109. Sandri, M., et al., *Foxo transcription factors induce the atrophy-related ubiquitin ligase atrogen-1 and cause skeletal muscle atrophy*. Cell, 2004. **117**(3): p. 399-412.
110. Satchek, J.M., et al., *Rapid disuse and denervation atrophy involve transcriptional changes similar to those of muscle wasting during systemic diseases*. FASEB J, 2007. **21**(1): p. 140-55.
111. Zhao, J., et al., *FoxO3 coordinately activates protein degradation by the autophagic/lysosomal and proteasomal pathways in atrophying muscle cells*. Cell Metab, 2007. **6**(6): p. 472-83.
112. Rizzuto, R., et al., *Close contacts with the endoplasmic reticulum as determinants of mitochondrial Ca<sup>2+</sup> responses*. Science, 1998. **280**(5370): p. 1763-6.
113. Kaufman, R.J., et al., *The unfolded protein response in nutrient sensing and differentiation*. Nat Rev Mol Cell Biol, 2002. **3**(6): p. 411-21.
114. Berridge, M.J., *The endoplasmic reticulum: a multifunctional signaling organelle*. Cell Calcium, 2002. **32**(5-6): p. 235-49.
115. Kaufman, R.J., *Orchestrating the unfolded protein response in health and disease*. J Clin Invest, 2002. **110**(10): p. 1389-98.
116. Calton, M., et al., *IRE1 couples endoplasmic reticulum load to secretory capacity by processing the XBP-1 mRNA*. Nature, 2002. **415**(6867): p. 92-6.
117. Ron, D. and P. Walter, *Signal integration in the endoplasmic reticulum unfolded protein response*. Nat Rev Mol Cell Biol, 2007. **8**(7): p. 519-29.
118. Gething, M.J., *Role and regulation of the ER chaperone BiP*. Semin Cell Dev Biol, 1999. **10**(5): p. 465-72.
119. Shen, J., et al., *ER stress regulation of ATF6 localization by dissociation of BiP/GRP78 binding and unmasking of Golgi localization signals*. Dev Cell, 2002. **3**(1): p. 99-111.
120. Ye, J., et al., *ER stress induces cleavage of membrane-bound ATF6 by the same proteases that process SREBPs*. Mol Cell, 2000. **6**(6): p. 1355-64.

121. Haze, K., et al., *Mammalian transcription factor ATF6 is synthesized as a transmembrane protein and activated by proteolysis in response to endoplasmic reticulum stress*. Mol Biol Cell, 1999. **10**(11): p. 3787-99.
122. Adachi, Y., et al., *ATF6 is a transcription factor specializing in the regulation of quality control proteins in the endoplasmic reticulum*. Cell Struct Funct, 2008. **33**(1): p. 75-89.
123. Yoshida, H., et al., *XBP1 mRNA is induced by ATF6 and spliced by IRE1 in response to ER stress to produce a highly active transcription factor*. Cell, 2001. **107**(7): p. 881-91.
124. Yoshida, H., et al., *ATF6 activated by proteolysis binds in the presence of NF-Y (CBF) directly to the cis-acting element responsible for the mammalian unfolded protein response*. Mol Cell Biol, 2000. **20**(18): p. 6755-67.
125. Liu, C.Y., et al., *The protein kinase/endoribonuclease IRE1alpha that signals the unfolded protein response has a luminal N-terminal ligand-independent dimerization domain*. J Biol Chem, 2002. **277**(21): p. 18346-56.
126. Wang, X.Z., et al., *Cloning of mammalian Ire1 reveals diversity in the ER stress responses*. EMBO J, 1998. **17**(19): p. 5708-17.
127. Verfaillie, T., et al., *Linking ER Stress to Autophagy: Potential Implications for Cancer Therapy*. Int J Cell Biol, 2010. **2010**: p. 930509.
128. Bernales, S., K.L. McDonald, and P. Walter, *Autophagy counterbalances endoplasmic reticulum expansion during the unfolded protein response*. PLoS Biol, 2006. **4**(12): p. e423.
129. Okada, T., et al., *Distinct roles of activating transcription factor 6 (ATF6) and double-stranded RNA-activated protein kinase-like endoplasmic reticulum kinase (PERK) in transcription during the mammalian unfolded protein response*. Biochem J, 2002. **366**(Pt 2): p. 585-94.
130. Harding, H.P., Y. Zhang, and D. Ron, *Protein translation and folding are coupled by an endoplasmic-reticulum-resident kinase*. Nature, 1999. **397**(6716): p. 271-4.
131. Dever, T.E., *Gene-specific regulation by general translation factors*. Cell, 2002. **108**(4): p. 545-56.
132. Chen, J.J. and I.M. London, *Regulation of protein synthesis by heme-regulated eIF-2 alpha kinase*. Trends Biochem Sci, 1995. **20**(3): p. 105-8.
133. Harding, H.P., et al., *An integrated stress response regulates amino acid metabolism and resistance to oxidative stress*. Mol Cell, 2003. **11**(3): p. 619-33.
134. Harding, H.P., et al., *Perk is essential for translational regulation and cell survival during the unfolded protein response*. Mol Cell, 2000. **5**(5): p. 897-904.
135. Harding, H.P., et al., *Regulated translation initiation controls stress-induced gene expression in mammalian cells*. Mol Cell, 2000. **6**(5): p. 1099-108.
136. Fawcett, T.W., et al., *Complexes containing activating transcription factor (ATF)/cAMP-responsive-element-binding protein (CREB) interact with the CCAAT/enhancer-binding protein (C/EBP)-ATF composite site to regulate Gadd153 expression during the stress response*. Biochem J, 1999. **339** ( Pt 1): p. 135-41.
137. Cullinan, S.B., et al., *Nrf2 is a direct PERK substrate and effector of PERK-dependent cell survival*. Mol Cell Biol, 2003. **23**(20): p. 7198-209.

138. Itoh, K., et al., *Keap1 represses nuclear activation of antioxidant responsive elements by Nrf2 through binding to the amino-terminal Neh2 domain*. *Genes Dev*, 1999. **13**(1): p. 76-86.
139. Digaleh, H., M. Kiaei, and F. Khodaghali, *Nrf2 and Nrf1 signaling and ER stress crosstalk: implication for proteasomal degradation and autophagy*. *Cellular and Molecular Life Sciences*, 2013. **70**(24): p. 4681-94.
140. Nguyen, T., P.J. Sherratt, and C.B. Pickett, *Regulatory mechanisms controlling gene expression mediated by the antioxidant response element*. *Annu Rev Pharmacol Toxicol*, 2003. **43**: p. 233-60.
141. Cullinan, S.B. and J.A. Diehl, *PERK-dependent activation of Nrf2 contributes to redox homeostasis and cell survival following endoplasmic reticulum stress*. *J Biol Chem*, 2004. **279**(19): p. 20108-17.
142. McCullough, K.D., et al., *Gadd153 sensitizes cells to endoplasmic reticulum stress by down-regulating Bcl2 and perturbing the cellular redox state*. *Mol Cell Biol*, 2001. **21**(4): p. 1249-59.
143. Rodriguez, J., et al., *Pomegranate and green tea extracts protect against ER stress induced by a high-fat diet in skeletal muscle of mice*. *Eur J Nutr*, 2014.
144. Travers, K.J., et al., *Functional and genomic analyses reveal an essential coordination between the unfolded protein response and ER-associated degradation*. *Cell*, 2000. **101**(3): p. 249-58.
145. Ng, D.T., E.D. Spear, and P. Walter, *The unfolded protein response regulates multiple aspects of secretory and membrane protein biogenesis and endoplasmic reticulum quality control*. *J Cell Biol*, 2000. **150**(1): p. 77-88.
146. Yoshida, H., et al., *A time-dependent phase shift in the mammalian unfolded protein response*. *Dev Cell*, 2003. **4**(2): p. 265-71.
147. Kouroku, Y., et al., *ER stress (PERK/eIF2alpha phosphorylation) mediates the polyglutamine-induced LC3 conversion, an essential step for autophagy formation*. *Cell Death Differentiation*, 2007. **14**(2): p. 230-9.
148. Szegezdi, E., et al., *Mediators of endoplasmic reticulum stress-induced apoptosis*. *EMBO Rep*, 2006. **7**(9): p. 880-5.
149. Oyadomari, S. and M. Mori, *Roles of CHOP/GADD153 in endoplasmic reticulum stress*. *Cell Death Differ*, 2004. **11**(4): p. 381-9.
150. Ron, D. and J.F. Habener, *CHOP, a novel developmentally regulated nuclear protein that dimerizes with transcription factors C/EBP and LAP and functions as a dominant-negative inhibitor of gene transcription*. *Genes Dev*, 1992. **6**(3): p. 439-53.
151. Fornace, A.J., Jr., et al., *Mammalian genes coordinately regulated by growth arrest signals and DNA-damaging agents*. *Mol Cell Biol*, 1989. **9**(10): p. 4196-203.
152. Zinszner, H., et al., *CHOP is implicated in programmed cell death in response to impaired function of the endoplasmic reticulum*. *Genes Dev*, 1998. **12**(7): p. 982-95.
153. Han, J., et al., *ER-stress-induced transcriptional regulation increases protein synthesis leading to cell death*. *Nat Cell Biol*, 2013. **15**(5): p. 481-90.

154. Marciniak, S.J., et al., *CHOP induces death by promoting protein synthesis and oxidation in the stressed endoplasmic reticulum*. Genes Dev, 2004. **18**(24): p. 3066-77.
155. Heath-Engel, H.M., N.C. Chang, and G.C. Shore, *The endoplasmic reticulum in apoptosis and autophagy: role of the BCL-2 protein family*. Oncogene, 2008. **27**(50): p. 6419-33.
156. Puthalakath, H., et al., *ER stress triggers apoptosis by activating BH3-only protein Bim*. Cell, 2007. **129**(7): p. 1337-49.
157. Ghosh, A.P., et al., *CHOP potentially co-operates with FOXO3a in neuronal cells to regulate PUMA and BIM expression in response to ER stress*. PLoS One, 2012. **7**(6): p. e39586.
158. Fu, H.Y., et al., *Ablation of C/EBP homologous protein attenuates endoplasmic reticulum-mediated apoptosis and cardiac dysfunction induced by pressure overload*. Circulation, 2010. **122**(4): p. 361-9.
159. Ogata, T., et al., *Differential cell death regulation between adult-unloaded and aged rat soleus muscle*. Mech Ageing Dev, 2009. **130**(5): p. 328-36.
160. Ozcan, U., et al., *Endoplasmic reticulum stress links obesity, insulin action, and type 2 diabetes*. Science, 2004. **306**(5695): p. 457-61.
161. Ikezoe, K., et al., *Endoplasmic reticulum stress in myotonic dystrophy type 1 muscle*. Acta Neuropathol, 2007. **114**(5): p. 527-35.
162. Nogalska, A., et al., *Endoplasmic reticulum stress induces myostatin precursor protein and NF-kappaB in cultured human muscle fibers: relevance to inclusion body myositis*. Exp Neurol, 2007. **204**(2): p. 610-8.
163. Ebert, S.M., et al., *The transcription factor ATF4 promotes skeletal myofiber atrophy during fasting*. Mol Endocrinol, 2010. **24**(4): p. 790-9.
164. Kalish, B.T., E.M. Fallon, and M. Puder, *A tutorial on fatty acid biology*. JPEN J Parenter Enteral Nutr, 2012. **36**(4): p. 380-8.
165. Ibaruren, M., D.J. Lopez, and P.V. Escriba, *The effect of natural and synthetic fatty acids on membrane structure, microdomain organization, cellular functions and human health*. Biochim Biophys Acta, 2014. **1838**(6): p. 1518-28.
166. Burr, G.O. and M.M. Burr, *Nutrition classics from The Journal of Biological Chemistry 82:345-67, 1929. A new deficiency disease produced by the rigid exclusion of fat from the diet*. Nutr Rev, 1973. **31**(8): p. 248-9.
167. Innis, S.M., *Essential fatty acids in growth and development*. Prog Lipid Res, 1991. **30**(1): p. 39-103.
168. Brossard N, C.M.P.C.R.J.P.T.J.L.L.M., *Retroconversion and metabolism of [13C]22:6n-3 in humans and rats after intake of a single dose of [13C]22:6n-3-triacylglycerols*. Am J Clin Nutr, 1996.
169. Conquer, J.A. and B.J. Holub, *Dietary docosahexaenoic acid as a source of eicosapentaenoic acid in vegetarians and omnivores*. Lipids, 1997. **32**(3): p. 341-5.
170. Conquer Ja, H.B.J., *Supplementation with an algae source of docosahexaenoic acid increases (n-3) fatty acid status and alters selected risk factors for heart disease in vegetarian subjects*. J Nutr, 1996.

171. Reddy, S., T.A. Sanders, and O. Obeid, *The influence of maternal vegetarian diet on essential fatty acid status of the newborn*. Eur J Clin Nutr, 1994. **48**(5): p. 358-68.
172. Baum, S.J., et al., *Fatty acids in cardiovascular health and disease: a comprehensive update*. J Clin Lipidol, 2012. **6**(3): p. 216-34.
173. Otten, J.J., J.P. Hellwig, and L.D. Meyers, *DRI, dietary reference intakes : the essential guide to nutrient requirements*. 2006, Washington, D.C.: National Academies Press. xiii, 543 p.
174. Holub, B.J., *Clinical nutrition: 4. Omega-3 fatty acids in cardiovascular care*. CMAJ, 2002. **166**(5): p. 608-15.
175. Nesheim, M.C., A.L. Yaktine, and Institute of Medicine (U.S.). Committee on Nutrient Relationships in Seafood: Selections to Balance Benefits and Risk., *Seafood choices : balancing benefits and risks*. 2007, Washington, D.C.: National Academies Press. xiv, 722 p.
176. Kromhout, D. and J. de Goede, *Update on cardiometabolic health effects of omega-3 fatty acids*. Curr Opin Lipidol, 2014. **25**(1): p. 85-90.
177. Inoue, T., et al., *Effect of fatty acids on phase behavior of hydrated dipalmitoylphosphatidylcholine bilayer: saturated versus unsaturated fatty acids*. Chem Phys Lipids, 2001. **109**(2): p. 117-33.
178. Stillwell, W. and S.R. Wassall, *Docosahexaenoic acid: membrane properties of a unique fatty acid*. Chem Phys Lipids, 2003. **126**(1): p. 1-27.
179. Shaikh, S.R., et al., *How polyunsaturated fatty acids modify molecular organization in membranes: Insight from NMR studies of model systems*. Biochim Biophys Acta, 2014.
180. Bergeron, K., et al., *Long-chain n-3 fatty acids enhance neonatal insulin-regulated protein metabolism in piglets by differentially altering muscle lipid composition*. J Lipid Res, 2007. **48**(11): p. 2396-410.
181. Barbieri, E., et al., *Mitohormesis in muscle cells: a morphological, molecular, and proteomic approach*. Muscles Ligaments Tendons J, 2013. **3**(4): p. 254-66.
182. Staiger, H., et al., *Fatty acid-induced differential regulation of the genes encoding peroxisome proliferator-activated receptor-gamma coactivator-1alpha and -1beta in human skeletal muscle cells that have been differentiated in vitro*. Diabetologia, 2005. **48**(10): p. 2115-8.
183. Hirabara, S.M., R. Curi, and P. Maechler, *Saturated fatty acid-induced insulin resistance is associated with mitochondrial dysfunction in skeletal muscle cells*. J Cell Physiol, 2010. **222**(1): p. 187-94.
184. Yuzefovych, L., G. Wilson, and L. Rachek, *Different effects of oleate vs. palmitate on mitochondrial function, apoptosis, and insulin signaling in L6 skeletal muscle cells: role of oxidative stress*. Am J Physiol Endocrinol Metab, 2010. **299**(6): p. E1096-105.
185. Monteiro, J.P., et al., *Rapeseed oil-rich diet alters hepatic mitochondrial membrane lipid composition and disrupts bioenergetics*. Arch Toxicol, 2013. **87**(12): p. 2151-63.
186. Monteiro, J.P., P.J. Oliveira, and A.S. Jurado, *Mitochondrial membrane lipid remodeling in pathophysiology: a new target for diet and therapeutic interventions*. Prog Lipid Res, 2013. **52**(4): p. 513-28.



187. Henique, C., et al., *Increased mitochondrial fatty acid oxidation is sufficient to protect skeletal muscle cells from palmitate-induced apoptosis*. J Biol Chem, 2010. **285**(47): p. 36818-27.
188. Lam, Y.Y., et al., *Insulin-stimulated glucose uptake and pathways regulating energy metabolism in skeletal muscle cells: the effects of subcutaneous and visceral fat, and long-chain saturated, n-3 and n-6 polyunsaturated fatty acids*. Biochim Biophys Acta, 2011. **1811**(7-8): p. 468-75.
189. Hu, W., et al., *Differential regulation of dihydroceramide desaturase by palmitate versus monounsaturated fatty acids: implications for insulin resistance*. J Biol Chem, 2011. **286**(19): p. 16596-605.
190. Verma, M.K., et al., *Inhibition of neutral sphingomyelinases in skeletal muscle attenuates fatty-acid induced defects in metabolism and stress*. Springerplus, 2014. **3**: p. 255.
191. Leyton, J., P.J. Drury, and M.A. Crawford, *Differential oxidation of saturated and unsaturated fatty acids in vivo in the rat*. Br J Nutr, 1987. **57**(3): p. 383-93.
192. Couet, C., et al., *Effect of dietary fish oil on body fat mass and basal fat oxidation in healthy adults*. Int J Obes Relat Metab Disord, 1997. **21**(8): p. 637-43.
193. Buckley, J.D. and P.R. Howe, *Anti-obesity effects of long-chain omega-3 polyunsaturated fatty acids*. Obes Rev, 2009. **10**(6): p. 648-59.
194. Boden, G., *Fatty acids and insulin resistance*. Diabetes Care, 1996. **19**(4): p. 394-5.
195. Santomauro, A.T., et al., *Overnight lowering of free fatty acids with Acipimox improves insulin resistance and glucose tolerance in obese diabetic and nondiabetic subjects*. Diabetes, 1999. **48**(9): p. 1836-41.
196. Mullen, K.L., et al., *Adiponectin resistance precedes the accumulation of skeletal muscle lipids and insulin resistance in high-fat-fed rats*. Am J Physiol Regul Integr Comp Physiol, 2009. **296**(2): p. R243-51.
197. Holloway, G.P., et al., *In obese rat muscle transport of palmitate is increased and is channeled to triacylglycerol storage despite an increase in mitochondrial palmitate oxidation*. Am J Physiol Endocrinol Metab, 2009. **296**(4): p. E738-47.
198. Bonen, A., et al., *Triacylglycerol accumulation in human obesity and type 2 diabetes is associated with increased rates of skeletal muscle fatty acid transport and increased sarcolemmal FAT/CD36*. FASEB J, 2004. **18**(10): p. 1144-6.
199. Goodpaster, B.H., et al., *Intramuscular lipid content is increased in obesity and decreased by weight loss*. Metabolism, 2000. **49**(4): p. 467-72.
200. Kelley, D.E., *Skeletal muscle triglycerides: an aspect of regional adiposity and insulin resistance*. Ann N Y Acad Sci, 2002. **967**: p. 135-45.
201. Kelley, D.E., et al., *Dysfunction of mitochondria in human skeletal muscle in type 2 diabetes*. Diabetes, 2002. **51**(10): p. 2944-50.
202. Kelley, D.E., B.H. Goodpaster, and L. Storlien, *Muscle triglyceride and insulin resistance*. Annu Rev Nutr, 2002. **22**: p. 325-46.
203. Srikanthan, P., et al., *Characterization of Intra-myocellular Lipids using 2D Localized Correlated Spectroscopy and Abdominal Fat using MRI in Type 2 Diabetes*. Magnetic Resonance Insights, 2012. **5**: p. 29-36.

204. Bryner, R.W., et al., *Docosahexaenoic Acid Protects Muscle Cells from Palmitate-Induced Atrophy*. International Scholarly Research Network Obesity, 2012. **Article ID 647348**.
205. White, P.J., et al., *Transgenic restoration of long-chain n-3 fatty acids in insulin target tissues improves resolution capacity and alleviates obesity-linked inflammation and insulin resistance in high-fat-fed mice*. Diabetes, 2010. **59**(12): p. 3066-73.
206. Smith, B.K., et al., *A decreased n-6/n-3 ratio in the fat-1 mouse is associated with improved glucose tolerance*. Appl Physiol Nutr Metab, 2010. **35**(5): p. 699-706.
207. Rivellesse, A.A., et al., *Long-term effects of fish oil on insulin resistance and plasma lipoproteins in NIDDM patients with hypertriglyceridemia*. Diabetes Care, 1996. **19**(11): p. 1207-13.
208. Friedberg, C.E., et al., *Fish oil and glycemic control in diabetes. A meta-analysis*. Diabetes Care, 1998. **21**(4): p. 494-500.
209. Lombardo, Y.B. and A.G. Chicco, *Effects of dietary polyunsaturated n-3 fatty acids on dyslipidemia and insulin resistance in rodents and humans. A review*. J Nutr Biochem, 2006. **17**(1): p. 1-13.
210. Cao, J., et al., *Saturated fatty acid induction of endoplasmic reticulum stress and apoptosis in human liver cells via the PERK/ATF4/CHOP signaling pathway*. Mol Cell Biochem, 2012. **364**(1-2): p. 115-29.
211. Wang, D., Y. Wei, and M.J. Pagliassotti, *Saturated fatty acids promote endoplasmic reticulum stress and liver injury in rats with hepatic steatosis*. Endocrinology, 2006. **147**(2): p. 943-51.
212. Deldicque, L., et al., *ER stress induces anabolic resistance in muscle cells through PKB-induced blockade of mTORC1*. PLoS One, 2011. **6**(6): p. e20993.
213. Yuzefovych, L.V., et al., *Protection from palmitate-induced mitochondrial DNA damage prevents from mitochondrial oxidative stress, mitochondrial dysfunction, apoptosis, and impaired insulin signaling in rat L6 skeletal muscle cells*. Endocrinology, 2012. **153**(1): p. 92-100.
214. Yuzefovych, L.V., et al., *Mitochondrial DNA damage via augmented oxidative stress regulates endoplasmic reticulum stress and autophagy: crosstalk, links and signaling*. PLoS One, 2013. **8**(12): p. e83349.
215. Peterson, J.M., et al., *Bax signaling regulates palmitate-mediated apoptosis in C(2)C(12) myotubes*. Am J Physiol Endocrinol Metab, 2008. **295**(6): p. E1307-14.
216. Zhu H, Y.Y.W.Y.L.J.S.P.W.P.T., *MicroRNA-195 promotes palmitate-induced apoptosis in cardiomyocytes by down-regulating Sirt1*. Cardiovasc Res, 2011. **0**(0): p. 0.
217. Begum, G., et al., *DHA inhibits ER Ca<sup>2+</sup> release and ER stress in astrocytes following in vitro ischemia*. J Neurochem, 2012. **120**(4): p. 622-30.
218. Begum, G., et al., *ER stress and effects of DHA as an ER stress inhibitor*. Transl Stroke Res, 2013. **4**(6): p. 635-42.
219. Begum, G., et al., *Docosahexaenoic acid reduces ER stress and abnormal protein accumulation and improves neuronal function following traumatic brain injury*. J Neurosci, 2014. **34**(10): p. 3743-55.
220. Ajami, M., et al., *Expression of Bcl-2 and Bax after hippocampal ischemia in DHA + EPA treated rats*. Neurol Sci, 2011. **32**(5): p. 811-8.

221. Khairallah, R.J., et al., *Treatment with docosahexaenoic acid, but not eicosapentaenoic acid, delays Ca<sup>2+</sup>-induced mitochondria permeability transition in normal and hypertrophied myocardium.* J Pharmacol Exp Ther, 2010. **335**(1): p. 155-62.
222. Welch, A.A., et al., *Dietary fat and fatty acid profile are associated with indices of skeletal muscle mass in women aged 18-79 years.* J Nutr, 2014. **144**(3): p. 327-34.
223. Ryan, A.S., et al., *Atrophy and intramuscular fat in specific muscles of the thigh: associated weakness and hyperinsulinemia in stroke survivors.* Neurorehabil Neural Repair, 2011. **25**(9): p. 865-72.
224. Elder, C.P., et al., *Intramuscular fat and glucose tolerance after spinal cord injury--a cross-sectional study.* Spinal Cord, 2004. **42**(12): p. 711-6.
225. Sitnick, M., S.C. Bodine, and J.C. Rutledge, *Chronic high fat feeding attenuates load-induced hypertrophy in mice.* J Physiol, 2009. **587**(Pt 23): p. 5753-65.
226. Feng, X.T., et al., *Palmitate contributes to insulin resistance through downregulation of the Src-mediated phosphorylation of Akt in C2C12 myotubes.* Biosci Biotechnol Biochem, 2012. **76**(7): p. 1356-61.
227. Zhang, J., et al., *Overactivation of NF-kappaB impairs insulin sensitivity and mediates palmitate-induced insulin resistance in C2C12 skeletal muscle cells.* Endocrine, 2010. **37**(1): p. 157-66.
228. Zhou, Q., et al., *Evidence for adipose-muscle cross talk: opposing regulation of muscle proteolysis by adiponectin and fatty acids.* Endocrinology, 2007. **148**(12): p. 5696-705.
229. Finlin, B.S., et al., *DHA reduces the atrophy-associated Fn14 protein in differentiated myotubes during coculture with macrophages.* J Nutr Biochem, 2012. **23**(8): p. 885-91.
230. Rachek, L.I., et al., *Palmitate induced mitochondrial deoxyribonucleic acid damage and apoptosis in l6 rat skeletal muscle cells.* Endocrinology, 2007. **148**(1): p. 293-9.
231. Yen, Y.P., et al., *Arsenic induces apoptosis in myoblasts through a reactive oxygen species-induced endoplasmic reticulum stress and mitochondrial dysfunction pathway.* Arch Toxicol, 2012. **86**(6): p. 923-33.
232. Komiya, K., et al., *Free fatty acids stimulate autophagy in pancreatic beta-cells via JNK pathway.* Biochem Biophys Res Commun, 2010. **401**(4): p. 561-7.
233. Bollheimer, L.C., et al., *Sarcopenia in the aging high-fat fed rat: a pilot study for modeling sarcopenic obesity in rodents.* Biogerontology, 2012. **13**(6): p. 609-20.
234. Sishi, B., et al., *Diet-induced obesity alters signalling pathways and induces atrophy and apoptosis in skeletal muscle in a prediabetic rat model.* Exp Physiol, 2011. **96**(2): p. 179-93.
235. du Toit, E.F., et al., *Myocardial susceptibility to ischemic-reperfusion injury in a prediabetic model of dietary-induced obesity.* Am J Physiol Heart Circ Physiol, 2008. **294**(5): p. H2336-43.
236. Murphy, R.A., et al., *Skeletal muscle depletion is associated with reduced plasma (n-3) fatty acids in non-small cell lung cancer patients.* J Nutr, 2010. **140**(9): p. 1602-6.

237. Murphy, R.A., et al., *Nutritional intervention with fish oil provides a benefit over standard of care for weight and skeletal muscle mass in patients with nonsmall cell lung cancer receiving chemotherapy*. *Cancer*, 2011. **117**(8): p. 1775-82.
238. Kamolrat, T. and S.R. Gray, *The effect of eicosapentaenoic and docosahexaenoic acid on protein synthesis and breakdown in murine C2C12 myotubes*. *Biochem Biophys Res Commun*, 2013. **432**(4): p. 593-8.
239. Castellero E, M.-n.A.I.L.A.p.-M.a.M.V.a.M.A.L.A.p.-C.n.A., *Eicosapentaenoic acid attenuates arthritis-induced muscle wasting acting on atrogen-1 and on myogenic regulatory factors*. *Am J Physiol Regul Integr Comp Physiol*, 2009. **297**(5): p. R1322-31.
240. Khal, J. and M.J. Tisdale, *Downregulation of muscle protein degradation in sepsis by eicosapentaenoic acid (EPA)*. *Biochem Biophys Res Commun*, 2008. **375**(2): p. 238-40.
241. Whitehouse, A.S., et al., *Mechanism of attenuation of skeletal muscle protein catabolism in cancer cachexia by eicosapentaenoic acid*. *Cancer research*, 2001. **61**(9): p. 3604-9.
242. Beck, S.A., K.L. Smith, and M.J. Tisdale, *Anticachectic and antitumor effect of eicosapentaenoic acid and its effect on protein turnover*. *Cancer Res*, 1991. **51**(22): p. 6089-93.
243. Smith, H.J., N.A. Greenberg, and M.J. Tisdale, *Effect of eicosapentaenoic acid, protein and amino acids on protein synthesis and degradation in skeletal muscle of cachectic mice*. *Br J Cancer*, 2004. **91**(2): p. 408-12.
244. Smith, H.J. and M.J. Tisdale, *Induction of apoptosis by a cachectic-factor in murine myotubes and inhibition by eicosapentaenoic acid*. *Apoptosis*, 2003. **8**(2): p. 161-9.
245. Whitehouse, A.S. and M.J. Tisdale, *Downregulation of ubiquitin-dependent proteolysis by eicosapentaenoic acid in acute starvation*. *Biochem Biophys Res Commun*, 2001.
246. Mittal, A., et al., *The TWEAK-Fn14 system is a critical regulator of denervation-induced skeletal muscle atrophy in mice*. *J Cell Biol*, 2010. **188**(6): p. 833-49.
247. Little, J.P. and S.M. Phillips, *Resistance exercise and nutrition to counteract muscle wasting*. *Appl Physiol Nutr Metab*, 2009. **34**(5): p. 817-28.
248. Eddins, M.J., et al., *Targeting the ubiquitin E3 ligase MuRF1 to inhibit muscle atrophy*. *Cell Biochemistry and Biophysics*, 2011. **60**(1-2): p. 113-8.
249. German, O.L., et al., *Docosahexaenoic acid prevents apoptosis of retina photoreceptors by activating the ERK/MAPK pathway*. *J Neurochem*, 2006. **98**(5): p. 1507-20.
250. Akbar, M. and H.Y. Kim, *Protective effects of docosahexaenoic acid in staurosporine-induced apoptosis: involvement of phosphatidylinositol-3 kinase pathway*. *J Neurochem*, 2002. **82**(3): p. 655-65.
251. Arnal, E., et al., *Beneficial effect of docosahexanoic acid and lutein on retinal structural, metabolic, and functional abnormalities in diabetic rats*. *Curr Eye Res*, 2009. **34**(11): p. 928-38.
252. Lu, J., et al., *Polyunsaturated fatty acids block platelet-activating factor-induced phosphatidylinositol 3 kinase/Akt-mediated apoptosis in intestinal epithelial cells*. *Am J Physiol Gastrointest Liver Physiol*, 2008. **294**(5): p. G1181-90.

253. Cottin, S.C., T.A. Sanders, and W.L. Hall, *The differential effects of EPA and DHA on cardiovascular risk factors*. Proc Nutr Soc, 2011. **70**(2): p. 215-31.
254. Mozaffarian, D. and J.H. Wu, *(n-3) fatty acids and cardiovascular health: are effects of EPA and DHA shared or complementary?* J Nutr, 2012. **142**(3): p. 614S-625S.
255. Jagoe, R.T. and A.L. Goldberg, *What do we really know about the ubiquitin-proteasome pathway in muscle atrophy?* Curr Opin Clin Nutr Metab Care, 2001. **4**(3): p. 183-90.
256. Franch, H.A., et al., *Acidosis impairs insulin receptor substrate-1-associated phosphoinositide 3-kinase signaling in muscle cells: consequences on proteolysis*. Am J Physiol Renal Physiol, 2004. **287**(4): p. F700-6.
257. Gulve, E.A. and J.F. Dice, *Regulation of protein synthesis and degradation in L8 myotubes. Effects of serum, insulin and insulin-like growth factors*. Biochem J, 1989. **260**(2): p. 377-87.
258. Hussain, S.N., et al., *Mechanical ventilation-induced diaphragm disuse in humans triggers autophagy*. American Journal of Respiratory and Critical Care Medicine, 2010. **182**(11): p. 1377-86.
259. Woodworth-Hobbs, M.E., et al., *Docosahexaenoic acid prevents palmitate-induced activation of proteolytic systems in C2C12 myotubes*. J Nutr Biochem, 2014.
260. Martinez, J., et al., *Microtubule-associated protein 1 light chain 3 alpha (LC3)-associated phagocytosis is required for the efficient clearance of dead cells*. Proc Natl Acad Sci U S A, 2011. **108**(42): p. 17396-401.
261. De Palma, C., et al., *Autophagy as a new therapeutic target in Duchenne muscular dystrophy*. Cell Death Dis, 2012. **3**: p. e418.
262. Siu, F., et al., *ATF4 is a mediator of the nutrient-sensing response pathway that activates the human asparagine synthetase gene*. J Biol Chem, 2002. **277**(27): p. 24120-7.
263. Dey, S., et al., *Both transcriptional regulation and translational control of ATF4 are central to the integrated stress response*. J Biol Chem, 2010. **285**(43): p. 33165-74.
264. Hamacher-Brady, A., et al., *Response to myocardial ischemia/reperfusion injury involves Bnip3 and autophagy*. Cell Death Differ, 2007. **14**(1): p. 146-57.
265. MacLennan, D.H. and P.C. Holland, *Calcium transport in sarcoplasmic reticulum*. Annu Rev Biophys Bioeng, 1975. **4**(00): p. 377-404.
266. Fiehn, W., et al., *Lipids and fatty acids of sarcolemma, sarcoplasmic reticulum, and mitochondria from rat skeletal muscle*. J Biol Chem, 1971. **246**(18): p. 5617-20.
267. Nezami, B.G., et al., *MicroRNA 375 mediates palmitate-induced enteric neuronal damage and high-fat diet-induced delayed intestinal transit in mice*. Gastroenterology, 2014. **146**(2): p. 473-83 e3.
268. Brunet, A., et al., *Stress-dependent regulation of FOXO transcription factors by the SIRT1 deacetylase*. Science, 2004. **303**(5666): p. 2011-5.
269. Gerhart-Hines, Z., et al., *Metabolic control of muscle mitochondrial function and fatty acid oxidation through SIRT1/PGC-1alpha*. EMBO J, 2007. **26**(7): p. 1913-23.

270. Lagouge, M., et al., *Resveratrol improves mitochondrial function and protects against metabolic disease by activating SIRT1 and PGC-1alpha*. *Cell*, 2006. **127**(6): p. 1109-22.
271. Xue, B., et al., *Omega-3 polyunsaturated fatty acids antagonize macrophage inflammation via activation of AMPK/SIRT1 pathway*. *PLoS One*, 2012. **7**(10): p. e45990.
272. Jung, S.B., et al., *Docosahexaenoic acid improves vascular function via up-regulation of SIRT1 expression in endothelial cells*. *Biochem Biophys Res Commun*, 2013. **437**(1): p. 114-9.