

Distribution Agreement

In presenting this dissertation as a partial fulfillment of the requirements for an advanced degree from Emory University, I hereby grant to Emory University and its agents the non-exclusive license to archive, make accessible, and display my thesis or dissertation in whole or in part in all forms of media, now or hereafter known, including display on the world wide web. I understand that I may select some access restrictions as part of the online submission of this dissertation. I retain all ownership rights to the copyright of the dissertation. I also retain the right to use in future works (such as articles or books) all or part of this dissertation.

Adrienne N. Edwards

Date

The Global Regulatory Role of the RNA Binding Protein CsrA

by

Adrienne N. Edwards
Doctor of Philosophy

Graduate Division of Biological and Biomedical Sciences
Microbiology and Molecular Genetics

Tony Romeo, Ph.D.
Advisor

Victor DiRita, Ph.D.
Committee Member

Gordon G. Churchward, Ph.D.
Committee Member

Charles P. Moran, Ph.D.
Committee Member

Philip N. Rather, Ph.D.
Committee Member

William Shafer, Ph.D.
Committee Member

Accepted:

Lisa A. Tedesco, Ph.D.
Dean of the James T. Laney School of Graduate Studies

Date

The Global Regulatory Role of the RNA Binding Protein CsrA

by

Adrienne N. Edwards
B.S., University of Georgia, 2004

Advisor: Tony Romeo, Ph.D.

An abstract of
A dissertation submitted to the Faculty of the
James T. Laney School of Graduate Studies of Emory University
in partial fulfillment of the requirements for the degree of
Doctor of Philosophy

in

Graduate Division of Biological and Biomedical Sciences
Microbiology and Molecular Genetics

2010

Abstract

The Global Regulatory Role of the RNA Binding Protein CsrA

By Adrienne N. Edwards

CsrA influences several important cellular processes by binding to target mRNAs and altering their translation and/or stability. CsrA activity is antagonized by two sRNAs, CsrB and CsrC. To elucidate the global role of CsrA, we combined a biochemical method with high throughput cDNA sequencing to determine the identities of mRNAs that directly bound to *Escherichia coli* CsrA in vivo. Among the 721 transcripts discovered were *relA*, *spoT* and *dksA*, which encode proteins that mediate the stringent response. RelA and SpoT are involved in guanosine tetraphosphate (ppGpp) metabolism, while DksA typically functions synergistically with ppGpp to potentiate the stringent response. CsrA directly repressed expression of *relA* and indirectly repressed *spoT* transcript levels, suggesting that CsrA may affect cellular ppGpp levels in certain conditions. CsrA directly activated *dksA* expression, but this effect was masked by DksA negative autoregulation. In turn, DksA and ppGpp activated *csrA*, *csrB* and *csrC* transcription. CsrA and DksA were both required for full expression of *csrB* and *csrC*, which required the response regulator UvrY. These complex direct and indirect regulatory interactions between the Csr and stringent response systems suggest that these systems function to finely tune gene expression in response to carbon metabolism and nutrient availability. In addition, a screen designed to find novel CsrA targets in *E. coli* using a microarray-based approach revealed that CsrA affected the expression of several GGDEF and EAL domain proteins. GGDEF and EAL domains are associated with c-di-GMP metabolism, a second messenger that positively influences biofilm formation and represses motility. CsrA directly repressed the expression of two GGDEF domain proteins in a post-transcriptional manner while modestly influencing the expression of five additional GGDEF/EAL domain proteins through unknown mechanisms. Cellular c-di-GMP concentrations were increased modestly in the *csrA* mutant, signifying that CsrA globally affects c-di-GMP synthesis. Finally, analysis of effects of CsrA on GGDEF/EAL domain proteins in *Salmonella* Typhimurium demonstrated that CsrA has both direct and indirect effects on regulating the switch between motility and biofilm formation. These studies have expanded the regulatory role of CsrA and suggest that CsrA governs cellular physiology and behavior on a global scale.

The Global Regulatory Role of the RNA Binding Protein CsrA

by

Adrienne N. Edwards
B.S., University of Georgia, 2004

Advisor: Tony Romeo, Ph.D.

A dissertation submitted to the Faculty of the
James T. Laney School of Graduate Studies of Emory University
in partial fulfillment of the requirements for the degree of
Doctor of Philosophy

in

Graduate Division of Biological and Biomedical Sciences
Program in Microbiology and Molecular Genetics

2010

ACKNOWLEDGEMENTS

This journey would never have been completed without the aid and encouragement of many people. First, I would like to thank Tony for his guidance and unwavering enthusiasm and encouragement. He provided me with hours upon hours of insightful discussion on a variety of scientific topics and afforded me with a number of additional opportunities to expand my graduate education, even from 300 miles away. Tony also allowed me to explore my own ideas, which inadvertently led me down some educational dead-ends but, most importantly, eventually broadened the scope of my major project.

I would like to thank my committee members who provided invaluable advice and suggestions on my work and remained strong advocates for me throughout my graduate career. I would like to show my appreciation to Gordon Churchward and Charlie Moran for always having an open door and providing me with guidance and support, especially towards the ends. I am also thankful that Vic DiRita remained a part of my education throughout my graduate studies, as it was not easy to leave the place of my graduate school beginnings. I would also like to thank Phil Rather for his discussions and openness about the academic career path and Bill Shafer for his unending enthusiasm toward my work and potential. Additionally, I want to express my gratitude that Tony and my committee had faith in me and allowed me to pursue the final two years of my studies independently at Emory.

I am extremely grateful to the Romeo lab members, past and present, especially Amy Kirby, Kazushi Suzuki, Yoshi Itoh, Archana Pannuri and Laura Patterson-Fortin. The environment was always exciting and provided many opportunities to learn and play. I am thankful for the companionship of both Carlos Goller and Jeff Mercante and for the encouragement and support.

My fruitful collaborations have been a huge part to my success throughout this endeavor. First, Mike Cashel and Kasia Potrykus were integral in helping me to complete my major project and without them, our study would not have been done with such careful consideration. Kristina Jonas and Ojar Melefors provided a mechanism for me to expand my knowledge and contribute to two important studies. I deeply enjoyed the numerous and enlightening email discussions we had across the Atlantic Ocean. Finally, Paul Babitzke provided an additional source of knowledge, expertise and technical details throughout my biochemical studies of protein-RNA interactions.

I am deeply indebted to Sidney Kushner for getting me into basic research in the first place. If it had not been for a free summer in college and his willingness to help me fill that time, I would have not gone down this particular road. His belief in my ability and talent propelled me forward into this career. In addition, the training I received in his lab from several capable hands, including Hili Giladi, Bijoy Mohanty, Tariq Perwez and Valerie Maples, proved to be a strong foundation. Both Bob Ivarie and Rich Meagher also succeeded in securing my future in science by translating their passion and enthusiasm into something contagious that I definitely caught.

I thank Konrad Bradley and Mike Hornback for keeping me sane for the months and months that I worked alone. They both helped to stave off loneliness and are true friends. In addition, Sam Roberts, Jeff Meisner, and Shantanu Bhatt were wonderful

sources for scientific and personal conversations. Without these people, graduate school would not have been as scientifically stimulating and definitely would have been duller.

I would like to thank all of my close friends and family, who patiently listened to my concerns, complaints and frustrations and consistently provided advice and cheered me on toward the finish line. Their support and love helped me to overcome my setbacks and remain focused. I would especially like to thank my sister, Erica Nehrling, who soon understood my struggles as she pursued her master's degree. While we are intensely competitive because we frequently have had the exact same interests, we love each other more. I am simultaneously more driven and more humble because of her.

My parents, Rick and Chris Nehrling, are instrumental in my successes as they instilled the confidence in me to succeed. They have never doubted my ability and have always gone above and beyond the call of duty to insure that I received the best education and experiences to prepare me for all of my endeavors, including graduate school. My parents are the ones who initially sparked my interest and love for biology. Between allowing my sister and I to have any pet we ever wanted to waking us in the middle of the night to show a snake Mom caught or baby seas turtles following the moonlight into the ocean that Dad discovered at the beach, I know my intense love and curiosity of nature and basic biology came from them. They not only serve as my moral compass and guiding light, but they are my confidants and best friends. They also provided me with my sense of humor, and I could not imagine having parents other than them.

Finally, my husband, Brian, has always been by my side. He has given me unwavering support and has spent countless hours listening me talk about science things that he does not understand and has joined me on numerous treks into lab at odd hours and days. He reminds me daily that I should always listen to and follow my heart. None of this would have been possible without his love and patience.

TABLE OF CONTENTS

Chapter 1. Introduction.....	1
Csr/Rsm regulatory system.....	1
<i>CsrA mechanism and regulation.....</i>	<i>2</i>
<i>Other components of the Csr regulatory system.....</i>	<i>5</i>
<i>CsrA regulated genes in E. coli K-12.....</i>	<i>8</i>
<i>The Csr/Rsm system in other organisms.....</i>	<i>11</i>
Stringent Response.....	16
<i>Metabolism and regulation of ppGpp.....</i>	<i>17</i>
<i>DksA, a cofactor for ppGpp regulation.....</i>	<i>23</i>
<i>Mechanism of ppGpp and DksA.....</i>	<i>25</i>
<i>Regulatory targets of ppGpp and DksA.....</i>	<i>29</i>
Regulation of biofilm formation and c-di-GMP.....	32
<i>Metabolism of c-di-GMP.....</i>	<i>33</i>
<i>Regulation by c-di-GMP.....</i>	<i>40</i>
Global regulatory networks and global regulons in prokaryotes.....	44
Conclusion.....	46
References.....	48
Chapter 2. Circuitry linking the Csr system and stringent response global regulatory systems.....	96
Abstract.....	97
Introduction.....	97
Results.....	101
Discussion.....	112
Materials and Methods.....	117
References.....	124
Chapter 3. The RNA binding protein CsrA controls cyclic di-GMP metabolism by directly regulating the expression of GGDEF proteins.....	153
Abstract.....	154
Introduction.....	154
Results.....	157
Discussion.....	170
Materials and Methods.....	175
References.....	183
Chapter 4. Complex regulatory network encompassing the Csr, c-di-GMP and motility systems of <i>Salmonella Typhimurium</i>.....	213
Abstract.....	214
Introduction.....	214
Results.....	217
Discussion.....	227
Materials and Methods.....	232
References.....	238

Chapter 5. Discussion.....	261
Global role of CsrA in <i>Escherichia coli</i>	261
Potential role of CsrA in regulation of secondary messenger metabolism.....	265
Complex interconnections between global regulatory networks.....	267
Outlook.....	271
References.....	272
 Appendix. Supporting Information for Chapter 2.....	 277

LIST OF TABLES AND FIGURES

Chapter 1.

Chapter 2.

Table 2-1. COG assignments for RNAs that copurified with CsrA-His ₆	136
Fig. 2-1. Gel shift analyses of CsrA binding to mRNA leaders of <i>relA</i> , <i>dksA</i> , <i>gmk</i> and <i>rpoZ</i>	144
Fig. 2-2. Effects of <i>csrA</i> on expression of <i>relA</i> , <i>spoT</i> and <i>dksA</i> reporter fusions.....	145
Fig. 2-3. Effect of <i>csrA</i> on <i>relA</i> , <i>spoT</i> and <i>dksA</i> transcript levels measured by real-time qRT-PCR, using strains MG1655 (wild-type) and TRMG1655 (<i>csrA</i> mutant).....	146
Fig. 2-4. Effect of <i>csrA</i> disruption and complementation on RelA, GMK and DksA protein levels by western blot analyses.....	147
Fig. 2-5. Effects of <i>dksA</i> and <i>csrA</i> on expression of chromosomally-encoded <i>dksA</i> translational, transcriptional, and leader fusions.....	148
Fig. 2-6. Effect of <i>dksA</i> on <i>dksA</i> transcription.....	149
Fig. 2-7. Effects of <i>dksA</i> , ppGpp and <i>rpoS</i> on <i>csrA</i> expression.....	150
Fig. 2-8. Effects of <i>dksA</i> and ppGpp on CsrB and CsrC RNA levels and gene expression.....	151
Fig. 2-9. Summary of the regulatory interactions between the Csr and stringent response systems in <i>E. coli</i> K-12.....	152

Chapter 3.

Table 3-1. Bacterial strains and plasmids used this study.....	194
Table 3-2. Primers used in this study.....	196
Fig. 3-1. Identification of <i>ycdT</i> and <i>ydeH</i> as novel targets for CsrA.....	204
Fig. 3-2. CsrA-dependent regulation of <i>ycdT</i> and <i>ydeH</i> expression measured by real-time RT-PCR.....	205
Fig. 3-3. Effects of other components of the BarA-UvrY-Csr network on <i>ycdT</i> and <i>ydeH</i> expression.....	206
Fig. 3-4. Physical interaction between CsrA and <i>ycdT</i> and <i>ydeH</i> transcripts.....	207
Fig. 3-5. The effects of YcdT and YdeH on motility.....	208
Fig. 3-6. High-resolution AFM analysis of cell morphology.....	209
Fig. 3-7. Functional characterization of YcdT and YdeH.....	210
Fig. 3-8. The global effect of CsrA on GGDEF/EAL proteins.....	211
Fig. 3-9. Schematic view of the interconnection between Csr and c-di-GMP signaling in <i>E. coli</i>	212

Chapter 4.

Table 4-1. GGDEF/EAL proteins regulated by CsrA.....	248
Table 4-2. 5' untranslated leader sequences of CsrA regulated genes.....	249
Table 4-3. Strains and plasmids used in this study.....	250

Fig. 4-1. CsrA regulates the mRNA steady state level of genes encoding GGDEF/EAL domain proteins in <i>S. Typhimurium</i>	255
Fig. 4-2. Direct interaction between CsrA and the transcripts of <i>STM1987</i> , <i>STM3375</i> , <i>STM3611</i> , <i>STM1344</i> and <i>STM1697</i>	256
Fig. 4-3. Indirect regulation of <i>STM3611</i> by CsrA through the flagella cascade.....	257
Fig. 4-4. Regulation of <i>STM3611</i> by CsrA.....	258
Fig. 4-5. CsrA-mediated regulation of <i>STM1344</i> and its downstream effects.....	259
Fig. 4-6. Schematic model illustrating the interplay between the Csr-, the c-di-GMP and the flagella regulatory system in <i>Salmonella Typhimurium</i>	260

Chapter 5.

Chapter 1. Introduction

To quickly sense and adapt to their environment, bacteria rely on regulatory systems that coordinate physiological processes. Several global regulatory networks are often required for efficient detection of multiple inputs to produce an appropriate response. Responses involve global changes in gene expression resulting in metabolic and physiological changes.

Frequently, bacteria use second messenger signaling molecules in the form of modified nucleotides to efficiently counter nutrient limitations and environmental stressors. These second messengers are quickly synthesized and diffused, and their synthesis and degradation are tightly controlled. The most well studied second messenger, cyclic AMP (cAMP), serves to alert cells to the status of the available carbon source, while others, such as a guanosine tetraphosphate (ppGpp) and cyclic di-GMP (c-di-GMP), are synthesized in response to a variety of conditions. Here, we describe the interconnections between the Csr global regulatory system and stringent response, which synthesizes ppGpp during nutritional stress, and how the Csr system regulates the metabolism of c-di-GMP in both *E. coli* and *Salmonella*, creating a complex regulatory network that controls motility and biofilm formation.

Csr/Rsm regulatory system

The Csr system is a global regulatory network that is found in many eubacteria, including pathogens, and has multiple pleiotropic effects on metabolism and cellular physiology. CsrA (carbon storage regulator), or its homolog RsmA (repressor of

secondary metabolites), is the central regulatory component of gene expression in this system and post-transcriptionally activates exponential phase processes such as glycolysis (Sabnis *et al.*, 1995), acetate metabolism (Wei *et al.*, 2000) and motility (Wei *et al.*, 2001), while repressing several stationary phase processes including glycogen metabolism (Romeo *et al.*, 1993), gluconeogenesis (Romeo *et al.*, 1993) and biofilm formation (Wang *et al.*, 2005). CsrA frequently exhibits opposite effects on opposing cellular processes; for example, CsrA inversely regulates motility and biofilm formation.

CsrA is a 61-amino acid RNA-binding protein that binds to the 5' untranslated region of messenger RNA to repress or activate expression by altering mRNA stability (Liu *et al.*, 1995) and/or by competing for binding to the Shine-Dalgarno and blocking efficient translation (Baker *et al.*, 2002). Other components of the Csr system include the small, noncoding RNAs, CsrB and CsrC, which possess multiple CsrA binding sites that titrate out CsrA activity by sequestering the protein (Liu *et al.*, 1997; Weilbacher *et al.*, 2003); the two component signal transduction system, BarA-UvrY, which is required for expression of CsrB and CsrC (Suzuki *et al.*, 2002); and CsrD, a specificity factor that targets both CsrB and CsrC for degradation by RNase E (Suzuki *et al.*, 2006).

CsrA mechanism and regulation

Systematic evolution of ligands by exponential enrichment (SELEX) revealed that CsrA recognizes RNA containing an almost invariant GGA sequence that is frequently located in the loop of RNA hairpins (Dubey *et al.*, 2005). The RNA secondary structure, often provided by conserved flanking nucleotides, is beneficial but not essential for high affinity binding. Structural studies of CsrA homologs demonstrate that CsrA forms a

symmetrical homodimer composed of interdigitated β -strands and represents a novel class of RNA-binding proteins (Gutierrez *et al.*, 2005; Rife *et al.*, 2005; Heeb *et al.*, 2006). Scanning alanine mutagenesis revealed that the amino acids critical for CsrA function are located within two β -strands that lie parallel to each other on either side of the homodimer, indicating that each CsrA dimer contains two identical RNA binding surfaces on opposite sides of the protein (Mercante *et al.*, 2006). Two residues within the RNA binding pocket, R44 and V24, come directly into contact with the critical GG motif of the target RNA (Schubert *et al.*, 2007).

Characterized CsrA mRNA targets contain from one (e.g. *hfq*) up to six (e.g. *pga*) binding sites (Wang *et al.*, 2005; Baker *et al.*, 2007). In the mechanism of CsrA-mediated negative regulation, CsrA binds with high affinity and specificity to the 5' untranslated region of transcripts at or near the Shine-Dalgarno (SD) sequence and competes for binding of the 30S ribosomal subunit (Baker *et al.*, 2002). In most cases, CsrA binding leads to rapid degradation of target transcripts either by passively affecting mRNA turnover due to the inhibition of translation or by directly increasing ribonucleolytic cleavage and turnover due to the presence of bound CsrA (Liu and Romeo, 1997). In transcripts that contain multiple binding sites, it is likely that CsrA first binds to the higher affinity binding site which then increases the local concentration to facilitate CsrA binding to the SD sequence or other sites (Mercante *et al.*, 2009). These studies also indicated that CsrA can simultaneously bind at two target binding sites within a single transcript, allowing for bridging between these two sites, and demonstrated that this feature is needed for full regulation in vitro (Mercante *et al.*, 2009). This suggests that CsrA dimers might tether non-adjacent binding sites within the

CsrA-CsrB complex, allowing for the globular form observed and the 1:2 ratio of CsrA dimers to binding sites within CsrB (Liu *et al.*, 1997).

Historically, the mechanism of positive regulation by CsrA has been less well understood than repression. Previous observations determined that CsrA binding stabilizes *flhDC* mRNA, leading to increased expression; however, this mechanism was not elucidated in detail (Wei *et al.*, 2001). Recent data demonstrate that CsrA activates *flhDC* expression by protecting the transcript from RNase E-mediated endonucleolytic cleavage (Baker *et al.*, 2010). RNase E preferentially interacts with RNA containing a 5'-monophosphate end before it initiates endonucleolytic cleavage (Mackie, 1998). CsrA binds at two sites within the 5' UTR of *flhDC*, one of which is located at the extreme 5' end, suggesting that CsrA inhibits the initial RNase E interaction with target transcripts (Baker *et al.*, 2010).

Finally, recent results reveal the ability of CsrA to interact with the intergenic region within a transcript (Yang *et al.*, 2010; A. Pannuri, A. N. Edwards, and T. Romeo, unpublished data), indicating a novel mechanism for CsrA regulation. CsrA binds to and represses the expression of *cel*, the third gene in the Colicin E7 operon of *E. coli*, which encodes the lysis gene. This study also reported the first account of a role for CsrA in regulating expression from an extrachromosomal element (Yang *et al.*, 2010).

Additionally, CsrA binds to the intergenic region of the *nhaA-nhaR* transcript with high affinity and specificity but does not bind to the 5' UTR of *nhaA*. Thus, CsrA represses expression of *nhaR* while having little effect on expression of *nhaA* (A. Pannuri, A. N. Edwards and T. Romeo, unpublished data). These studies suggest that the mechanistic

role of CsrA is still not fully explored and that there may be other ways in which CsrA interacts with RNA to mediate its regulatory effects.

Other components of the Csr regulatory system

CsrB was originally identified as RNA that copurified with histidine-tagged CsrA (Liu *et al.*, 1997) while CsrC was discovered during a genetic screen for additional factors that affect glycogen synthesis (Weilbacher *et al.*, 2003). Both of these noncoding small RNAs contain multiple GGA motifs: CsrB (369 nt) contains approximately 18-22 putative binding sites while CsrC (245 nt) is predicted to have approximately nine. Together, CsrB and CsrC antagonize CsrA activity by binding multiple CsrA dimers and reducing the availability of CsrA to interact with target mRNAs. The effects of CsrB and CsrC are CsrA-dependent, although each might be expressed differently under certain conditions, allowing for complex regulation of CsrA activity (Weilbacher *et al.*, 2003). CsrB and CsrC have relatively short half-lives (≈ 2 minutes), which permits their levels to be rapidly altered in response to changes in their synthesis (Gudapaty *et al.*, 2001; Weilbacher *et al.*, 2003).

CsrB and CsrC transcription is activated indirectly by CsrA through the BarA-UvrY two-component signal transduction system (Suzuki *et al.*, 2002). BarA is a tripartite sensor kinase and initiates a His-Asp-His phosphorelay in response to accumulation of acetate, the physiological stimulus for BarA activity (Chavez *et al.*, 2010). BarA phosphorylates its cognate response regulator, UvrY, which, in turn, activates transcription of *csrB* and *csrC* (Pernestig *et al.*, 2001; Suzuki *et al.*, 2002). BarA-UvrY is important for growth in low pH conditions and for switching between

glycolytic and gluconeogenic carbon sources (Pernestig *et al.*, 2003; Mondragon *et al.*, 2006). *csrB* and *csrC* expression is also upregulated in minimal media in a CsrA-, BarA- and UvrY-dependent manner, and the addition of tryptone, casamino acids or amino acids repressed mRNA levels of *csrB*, although the exact mechanism of the response was unidentified (Jonas and Melefors, 2009). Additionally, BarA-UvrY homologs in *Bordetella bronchiseptica* and *Legionella pneumophila* appear to act as rheostat-like switches rather than on/off switches, allowing for several phenotypic states depending upon the ratio of phosphorylated to unphosphorylated UvrY and the affinity of each UvrY-regulated promoter (Cotter and Miller, 1997; Edwards *et al.*, 2010). In *L. pneumophila*, modulation of the phosphorylation state of LetS, the UvrY homolog, results in delayed expression of both *rsmY* and *rsmZ* (CsrB/CsrC homologs) in the postexponential phase (Edwards *et al.*, 2010). While more than two phenotypic states in regards to UvrY-dependent promoters have not been identified in *E. coli*, it is tempting to speculate that this rheostat-like behavior could play a role in regulating CsrB and CsrC levels and, ultimately, CsrA activity.

CsrC transcription appears to be less dependent upon UvrY compared to CsrB (Suzuki *et al.*, 2002; Weilbacher *et al.*, 2003). Interestingly, deletion of one sRNA results in a compensatory effect, increasing the levels of the other (Weilbacher *et al.*, 2003), revealing an important feedback loop within the Csr circuit.

Finally, CsrD, a degenerate GGDEF-EAL domain protein, regulates the turnover of CsrB and CsrC (Suzuki *et al.*, 2006; Jonas *et al.*, 2006). Both *csrB* and *csrC* transcripts were significantly stabilized in a *csrD* mutant, and CsrD bound to these sRNAs in vitro with high affinity but no specificity (Suzuki *et al.*, 2006). It appears that

CsrD is required for targeting CsrB and CsrC degradation by RNase E (Suzuki *et al.*, 2006). CsrD was the first example of a GGDEF-EAL domain protein that is not involved in metabolism of c-di-GMP (Suzuki *et al.*, 2006).

The Csr circuitry is characterized by negative feedback loops that regulate CsrA activity. In one feedback loop, CsrA represses expression of *csrD* (Suzuki *et al.*, 2006), reducing turnover of CsrB and CsrC. In another, CsrA activates glycolysis (Sabnis *et al.*, 1995), a major source of acetate. Acetate, the physiological sensor for BarA activity (Chavez *et al.*, 2010), upregulates *csrB* and *csrC* expression. Recent data reveal that CsrA negatively regulates its own expression by directly binding to its mRNA leader (H. Yakhnin and P. Babitzke, unpublished data). These negative feedback loops provide a mechanism of fine-tuning CsrA expression and activity.

CsrA activity is regulated by the small RNAs, CsrB and CsrC, and is subject to transcriptional regulation as well. PmrA, the response regulator of the PmrAB two-component system, activates *csrA* expression, likely directly influencing transcription since a putative PmrA-binding site was identified in the *csrA* regulatory region (Rasis and Segal, 2009; P. Babitzke, personal communication). CsrA indirectly regulates its own transcription by inducing RpoS expression; transcription of *csrA* occurs from at least three promoters, one of which is σ^S -dependent (H. Yakhnin and P. Babitzke, unpublished data). These results suggest that CsrA and RpoS are two global regulatory proteins that participate in a positive regulatory circuit. Altogether, many regulatory inputs on multiple levels provide tightly controlled expression and activity of CsrA, highlighting the importance of precisely controlling CsrA activity in the cell.

CsrA regulated genes in E. coli K-12

CsrA was originally discovered as a regulator of the *glgCAP* operon by screening for transposon mutants that accumulated high levels of glycogen (Romeo *et al.*, 1993). CsrA directly represses expression of the three enzymes that are essential for glycogen biosynthesis, ADP-glucose pyrophosphorylase, glycogen synthase and glycogen branching enzyme, encoded by *glgC*, *glgA* and *glgB* (Liu *et al.*, 1995; Yang *et al.*, 1996). In addition, CsrA negatively regulates *glgP*, glycogen phosphorylase, and *glgS*, whose gene product promotes glycogen synthesis (Yang *et al.*, 1996). It has been further elucidated that CsrA plays an extensive role in regulating intracellular carbon flux by activating expression of glucose-6-phosphate isomerase, triose-phosphate isomerase and enolase, which are all glycolytic enzymes, along with repressing fructose-1,6-bisphosphatase, PEP carboxykinase and phosphoenolpyruvate synthetase, which are gluconeogenic enzymes (Sabnis *et al.*, 1995). Additionally, CsrA upregulates expression of *acs*, which encodes acetyl-coenzyme A synthetase, along with increasing the activity of the glyoxylate shunt enzyme, isocitrate lyase (Wei *et al.*, 2000). CsrA also has the potential to regulate transportation and utilization of amino acids through repression of *cstA* (Dubey *et al.*, 2003). These studies have revealed an important role that CsrA has in carbon flux and nutrient acquisition.

CsrA inversely controls motility and biofilm formation within *E. coli*. As mentioned above, CsrA activates motility by positively regulating the expression of *flhDC* (Wei *et al.*, 2001), which encodes for the two major subunits of the master regulator that induces the flagellar transcriptional cascade (Liu and Matsumura, 1994). In contrast, CsrA directly represses expression of *pgaABCD*, which encodes for the gene

products necessary to produce and secrete poly- β -1,6-N-acetyl-D-glucosamine (PGA), inhibiting biofilm formation (Wang *et al.*, 2005; Itoh *et al.*, 2008). There is evidence that CsrA negatively regulates biofilm production on multiple levels (A. Pannuri, A. N. Edwards and T. Romeo, unpublished data). CsrA directly represses expression of *nhaR*, whose gene product is an important transcriptional activator for *pgaABCD* expression (Goller *et al.*, 2006), and directly binds to the 5'UTR of *glmS*, which encodes the protein that catalyzes a rate-limiting step in production of UDP-GlcNAc, the precursor required for PGA biosynthesis. Additionally, CsrA represses expression of *ycdT* and *ydeH*, two GGDEF domain-containing proteins that synthesize c-di-GMP (Chapter 3). c-di-GMP has positive effects on biofilm production (see below) and has been shown to activate *pgaABCD* expression (Tagliabue *et al.*, 2010; M. Kumar, C. C. Goller and T. Romeo, unpublished data) and affect the level of PgaD protein (Boehm *et al.*, 2009; M. Kumar, C. C. Goller and T. Romeo, unpublished data).

While CsrA often influences biofilm and motility in other species, the effects are sometimes oppositely regulated by CsrA. In the Gram-positive *B. subtilis*, CsrA directly represses the expression of *hag*, encoding flagellin, employing a very similar mechanism of negative regulation as described above (Yakhnin *et al.*, 2007), while in *Campylobacter jejuni*, an ϵ -proteobacteria, CsrA activates biofilm formation and represses motility, although the molecular mechanisms for these phenotypic effects are not known (Fields and Thompson, 2008). In addition, RsmA represses swarming in *Proteus mirabilis* (Liaw *et al.*, 2003).

Interestingly, the *csrA* mutant allele (*csrA::kan*) that is frequently used for in vivo studies in *E. coli* still possesses some activity since the transposon insertion only

eliminated the last 11 amino acids of the original C-terminus, creating a 62 amino acid fusion protein (Romeo *et al.*, 1993; Timmermans and Van Melderren, 2009). In vitro data confirmed that the purified CsrA::Kan fusion protein still retains some RNA binding activity (C. Baker and P. Babitzke, unpublished data). These studies suggest that the regulatory role of CsrA may have been underestimated since the mutant allele utilized in many strains retains residual activity. A recent study indicates that the essentiality of a full *csrA* knockout grown on LB medium can be alleviated by the addition of pyruvate to the media, which enters the carbon cycle after glycolysis, or by eliminating carbon flux to glycogen biosynthesis by deleting the *glgCAP* operon, which encodes proteins involved in the primary steps for glycogen biosynthesis (Timmermans and Van Melderren, 2009). Here, the carbon flux either bypasses the glycolytic pathway or allows carbon to be redirected to glycolysis.

Despite the apparent global role of CsrA in both metabolism and physiology, little is known about the overall global influence of CsrA on gene expression. Two studies of global regulation by CsrA gave some insight through microarray analysis in *Salmonella enteric* serovar Typhimurium (Lawhon *et al.*, 2003) and *Pseudomonas aeruginosa* (Burrowes *et al.*, 2006). However, these types of studies do not exclude indirect effects of CsrA, probe for intergenic regions, nor account for altered metabolism in the *csrA* mutant. In addition, there is evidence that CsrA can inhibit translation without affecting transcript stability (Baker *et al.*, 2007), and these cases would be overlooked in array studies. A recent study used an approach similar to ours (described in Chapter 2) in which RNA that copurified with histidine-tagged RsmA was enriched, converted into cDNA, cloned, and subsequently sequenced to determine the identities of RNAs that

interact with RsmA in vivo (Brencic and Lory, 2009). These types of studies have elucidated many new putative targets of CsrA/RsmA and have also uncovered new potential mechanisms of CsrA regulation (A. Pannuri, A. N. Edwards and T. Romeo, unpublished data; L. Patterson-Fortin and T. Romeo, unpublished data).

The Csr/Rsm system in other organisms

The Csr circuit has been most carefully studied in *E. coli*; however, orthologous Csr systems and components are widely distributed in eubacteria, and some species appear to encode more than one CsrA homolog (Mercante *et al.*, 2006). While CsrA and the other components in this circuitry exist in many organisms, the influence that the Csr system has on physiological functions varies considerably, and there are notable differences from *E. coli* in several of the systems described below.

The Csr system of *Salmonella enterica* serovar Typhimurium is very similar to the *E. coli* system. The CsrA proteins of these species exhibit the same deduced amino acid sequence, and the two antagonizing sRNAs, CsrB and CsrC, are activated by the BarA-SirA TCS (BarA-UvrY in *E. coli*) (Teplitski *et al.*, 2003; Teplitski *et al.*, 2006; Fortune *et al.*, 2006). The Csr system plays a role in virulence through SirA activation of two key regulators of invasion, *hilA* and *hilC* (Teplitski *et al.*, 2003), along with regulating expression of the *Salmonella* pathogenicity island 1 (SPI1) (Altier *et al.*, 2000; Lawhon *et al.*, 2003). Similar to *E. coli*, a *csrA* mutant is amotile; however, microarray analysis suggests that CsrA could regulate approximately 8% of the genome, including some metabolic pathways not present in *E. coli* (Lawhon *et al.*, 2003). As evidenced by phenotypic observations in other organisms, it is apparent that CsrA levels must be

tightly controlled as both deletion and overexpression of *csrA* lead to a defect in invasion by *Salmonella* (Altier *et al.*, 2000).

RsmA (CsrA) and the GacS-GacA (BarA-UvrY) TCS have been studied in several species of *Pseudomonads*. Originally, the GacS-GacA system was discovered to control pathogenicity of the plant pathogen, *Pseudomonas syringae* pv. *syringae* (Hrabak and Willis, 1992; Rich *et al.*, 1994). However, more extensive studies with this system have been done in *P. fluorescens*, a plant biocontrol species important for protection against phytopathogenic fungi, and in *P. aeruginosa*, an opportunistic pathogen that frequently infects the lungs of immunocompromised and cystic fibrosis patients. The Rsm system in several *Pseudomonas* species represses hydrogen cyanide and extracellular protease production (Blumer *et al.*, 1999; Pessi *et al.*, 2001; Heeb *et al.*, 2002). In addition, the GacS-GacA TCS system positively regulates synthesis of *N*-acyl-homoserine lactones (AHL) (Reimann *et al.*, 1997; Chancey *et al.*, 1999; Kay *et al.*, 2006), a quorum-sensing signal, while RsmA has negative effects on AHL production (Pessi *et al.*, 2001; Burrowes *et al.*, 2005). In *P. fluorescens*, three RsmA/E-regulating sRNAs activate the synthesis of an unknown quorum-sensing signal, which is unrelated to AHLs (Kay *et al.*, 2005).

Studies in *P. fluorescens* have demonstrated the presence of two CsrA homologs, RsmA (Blumer *et al.*, 1999) and RsmE (Haas *et al.*, 2002; Reimann *et al.*, 2005), which are negatively regulated by three redundant sRNAs, RsmX, RsmY and RsmZ (Heeb *et al.*, 2002; Valverde *et al.*, 2003; Kay *et al.*, 2005). RsmA and RsmE indirectly activate transcription of the three sRNAs through the response regulator GacA, creating an autoregulatory loop similar to *E. coli*. Interestingly, all three sRNAs do not show the

same expression patterns; *rsmX* and *rsmY* gradually increase during growth while *rsmZ* expression is delayed (Kay *et al.*, 2005). Recent studies found that PsrA, a transcriptional regulator that activates *rpoS* expression and represses fatty acid degradation (Kang *et al.*, 2009), activates expression of *rsmZ* (Humair *et al.*, 2010), revealing an additional regulatory component within the Rsm system. In contrast to *E. coli*, RsmA represses expression of *rpoS*, although it is unknown if this regulation is direct or indirect (Heeb *et al.*, 2005).

P. aeruginosa strains possess a CsrA homolog (RsmA) (Pessi *et al.*, 2001), the GacS-GacA TCS (Kay *et al.*, 2006) and two sRNAs, RsmY (Valverde *et al.*, 2003; Burrowes *et al.*, 2005) and RsmZ (Heurlier *et al.*, 2004). Recently, additional regulators have been discovered. The sensor kinase RetS indirectly controls sRNA expression by modulating the phosphorylation state of GacS (Goodman *et al.*, 2004; Goodman *et al.*, 2009). LadS is another sensor kinase within this signaling network and functions in a manner opposite of RetS (Ventre *et al.*, 2006). Hfq has been reported to directly bind two regions of RsmY and stabilize the sRNA by protecting the transcript from endonucleolytic cleavage by RNase E (Sonnleitner *et al.*, 2006; Sorger-Domenigg *et al.*, 2007).

In *Vibrio cholerae*, the Csr system acts within the quorum sensing network and indirectly regulates the master regulator of quorum sensing, HapR (Lenz *et al.*, 2005). The VarS-VarA (BarA-UvrY) TCS is activated in a growth-dependent manner and induces expression of the three sRNAs, *csrB*, *csrC* and *csrD* at high cell density. The sRNA-mediated inhibition of CsrA indirectly reduces LuxO activity, reducing the expression of four sRNAs, *qrr1-4*, which work with Hfq in an antisense mechanism to

destabilize the *hapR* transcript. Thus, in low cell density, CsrA indirectly coordinates repression of HapR; in high cell density, the upregulation of the CsrA-regulating sRNAs indirectly stabilizes the *hapR* transcript, allowing for quorum-sensing-mediated regulation to occur. In support of this model, CsrA affects the expression of two quorum-sensing-regulated virulence genes, *vpsT* and *vpsL* (Lenz *et al.*, 2005), while mutations in the VarS-VarA-CsrA/CsrBCD pathway affect another HapR-regulated gene, *hapA* (Lenz *et al.*, 2005; Jang *et al.*, 2010). While these two studies suggest that the Csr system plays an integral role in controlling quorum sensing, further studies are needed to clarify the precise interactions between the components in *V. cholerae* Csr system.

Legionella pneumophila, an intracellular pathogen, depends upon the Csr system to coordinate differentiation between replicative and transmissive phases (Molofsky and Swanson, 2003). Preliminary data suggest that CsrA-mediated regulation depends upon ppGpp accumulation. During the intracellular replication phase, induction of the stringent response occurs after nutrient exhaustion (Hammer *et al.*, 2002), and subsequent ppGpp synthesis activates the LetS-LetA (BarA-UvrY homologs) TCS system in an unknown manner (Hammer *et al.*, 2002). LetA then directly induces transcription of *rsmY* and *rsmZ* (*csrB* and *csrC*) (Rasis and Segal, 2009; Sahr *et al.*, 2009), which reduces free CsrA and relieves repression of the transmission phase traits (Molofsky and Swanson, 2003). In addition, two studies indicate that RpoS induces expression of *rsmY* and *rsmZ* (Hovel-Miner *et al.*, 2009; Sahr *et al.*, 2009), providing another possible link between stress and induction of sRNA expression. However, more studies are needed to definitively establish this regulatory cascade. Interestingly, all sequenced strains of *L.*

pneumophila possess at least three *csrA* genes, perhaps highlighting the critical importance of CsrA in regulating *Legionella* life cycle.

The RsmA-GacS-GacA (CsrA-BarA-UvrY) system plays a crucial role in regulating synthesis of extracellular enzymes and polysaccharides, quorum sensing, secondary metabolite production, plant-microbe interactions and motility in the plant pathogen, *Erwinia caratovora* (Chatterjee *et al.*, 1995; Cui *et al.*, 1995; Cui *et al.*, 2001; Chatterjee *et al.*, 2010). This organism apparently possesses only a single sRNA, RsmB (Liu *et al.*, 1998). This system in *E. caratovora* is characterized by additional multiple regulators. RsmC is a transcriptional adaptor that inhibits FlhDC-dependent activation of *gacA* expression, thus reducing *rsmB* expression (Cui *et al.*, 1999; Cui *et al.*, 2008; Chatterjee *et al.*, 2009). KdgR also negatively regulates *rsmB* by binding within the transcribed region, perhaps by blocking efficient transcription (Liu *et al.*, 1999). HexA, a homolog to LhrA in *E. coli*, represses both *rsmB* and *rpoS* expression (Mukherjee *et al.*, 2000). Similarly to *E. coli*, RpoS activates expression of *rsmA* (Mukherjee *et al.*, 1998). Finally, both the Rsm and the quorum sensing network are interconnected (Koiv and Mae, 2001). Two receptors of AHL, ExpR1 and ExpR2 (homologous to LuxR in *E. coli*), directly activate *rsmA* transcription at low cell density, and this interaction is abolished in the presence of AHLs (Cui *et al.*, 2005; Chatterjee *et al.*, 2005; Cui *et al.*, 2006; Sjoblom *et al.*, 2006).

At present it is not clear that all bacterial species that possess homologs of CsrA contain homologs of the sRNAs, CsrB and CsrC, and/or the BarA-UvrY TCS. Homologs of *csrB* and *csrC* are notoriously difficult to identify since they are not easily recognized by homology searches (Weilbacher *et al.*, 2003). A bioinformatics study identified all

previously discovered CsrA-regulating sRNAs and predicted a number of similar sRNAs in a variety of bacteria (Kulkarni *et al.*, 2006). This study suggested that the use of sRNAs in regulating CsrA activity is somewhat conserved; however, CsrA-regulating sRNAs were not identified outside of γ -proteobacteria. In addition, BarA-UvrY homologs have only been described in γ -proteobacteria. It is unknown whether CsrA is regulated similarly in other bacteria or whether the Csr circuitry varies qualitatively in other bacterial species.

Stringent Response

The stringent response is characterized by a downshift in transcription of stable RNAs (i.e. rRNA and tRNA) and by the upregulation of transcription of a number of operons, such as those that encode proteins that mediate amino acid biosynthesis and transport, all in response to nutritional starvation. This adaptive mechanism, first described in 1961 (Stent and Brenner, 1961), couples inhibition of translation with a reduction in transcription, and leads to global changes within the transcriptome of starved cells. The effector of this response is guanosine tetraphosphate (ppGpp) or guanosine pentaphosphate (pppGpp) (collectively referred to here as ppGpp), a nucleotide alarmone that is common in eubacteria and plants (Mittenhuber, 2001). ppGpp was discovered over forty years ago as derivatives of GTP and GDP that appeared on two-dimensional thin layer chromatography from extracts of *E. coli* undergoing amino acid starvation and were termed then as “magic spots” (Cashel and Gallant, 1969). ppGpp is produced not only in response to amino acid starvation, but from other stresses and nutritional limitations including carbon (Hernandez and Bremer, 1991; Murray and Bremer, 1996;

Cashel *et al.*, 1996), iron (Vinella *et al.*, 2005) and fatty acid starvation (Seyfzadeh *et al.*, 1993; Gong *et al.*, 2002).

Metabolism and regulation of ppGpp

Levels of ppGpp are regulated by two classes of enzymes: monofunctional synthetase-only enzymes (RelA) and bifunctional synthetase/hydrolase enzymes (SpoT or RSH [RelA/SpoT homologue]). With the exception of *Neisseria* and *Bordetella* species, which belong to the β -proteobacteria subdivision, only *E. coli* and other γ -proteobacteria species possess the paralogues, RelA and SpoT (Mittenhuber, 2001). These enzymes synthesize ppGpp from GTP or GDP and use ATP to catalyze the addition of a pyrophosphate onto the ribose 3'-OH (Cochran and Byrne, 1974; Hernandez and Bremer, 1991; Xiao *et al.*, 1991), although SpoT exhibits weak synthetase activity and serves primarily as a manganese-dependent phosphohydrolase, degrading pppGpp or ppGpp to GTP or GDP and pyrophosphate (PP_i) (Heinemeyer and Richter, 1977; Sy, 1977; An *et al.*, 1979; Murray and Bremer, 1996, Cashel *et al.*, 1996). pppGpp can subsequently be converted to ppGpp by guanosine pentaphosphate hydrolase, GPP (Keasling *et al.*, 1993). Although the amino acid sequences of RelA, SpoT and RSH proteins are interrelated (Metzger *et al.*, 1989), RelA contains only synthetase activity because of the lack of the conserved histidine-aspartate (HD) domain required for the phosphohydrolase activity found in SpoT and RSH proteins (Aravind and Koonin, 1998). The synthetase and hydrolase domains overlap within the N-terminal portion of SpoT and RSH proteins (Gentry and Cashel, 1996; Avarbock *et al.*, 2005). In vivo and biochemical analyses, along with recent X-ray crystallography of the N-terminal fragment of Rel_{Seq} (RSH in

Streptococcus dysgalactiae subsp. *equisimilis*), have revealed reciprocal regulation of the two antagonistic activities (hydrolase-OFF/synthetase-ON and hydrolase-ON/synthetase-OFF) which prevents futile cycling of ppGpp synthesis and hydrolysis (Mechold *et al.*, 2002; Hogg *et al.*, 2004).

Unlike γ -proteobacteria and the few exceptions, most other organisms encode a single bifunctional RSH protein, often known as Rel or RelA (Mittenhuber, 2001). *Streptococcus mutants* (Lemos *et al.*, 2007), *Enterococcus faecilis* (Abranches *et al.*, 2009), *Bacillus subtilis* (Nanamiya *et al.*, 2008) and *Vibrio cholerae* (Das *et al.*, 2009), along with other predicted organisms, encode one or more monofunctional, RelA-like synthetase fragments, known as small alarmone synthetases (SASs), in addition to a single RSH protein. These proteins (termed RelP, RelQ, and RelV) lack both the hydrolase and the regulatory C-terminal domains but appear to be primarily responsible for basal level production of ppGpp in some organisms (Lemos *et al.*, 2007). SASs are hypothesized to function in ppGpp synthesis in a mechanism unique from RelA and SpoT, perhaps by sensing extracellular inputs. Unlike in *E. coli*, which encodes no SASs, accumulation of ppGpp in *V. cholerae* occurs in a *relA spoT* double mutant in response to glucose and fatty acid starvation in a RelV-dependent manner (Das *et al.*, 2009), demonstrating that these closely related bacteria have evolved different modes of regulation to respond to similar nutritional stresses. Importantly, in some organisms, but not all, that encode SASs, deletion of the bifunctional enzyme (RSH) is not lethal (Wendrich and Marahiel, 1997; Lemos *et al.*, 2004); this is in contrast to *spoT* mutants in *E. coli*, *V. cholerae* and other organisms that contain both RelA and SpoT (Xiao *et al.*, 1991; Das and Bhadra, 2008). The hydrolase activity of SpoT is essential in *relA*⁺ strains

probably because accumulation of RelA-derived ppGpp inhibits growth (Xiao *et al.*, 1991). This suggests that ppGpp synthesis by SASs is tightly governed in a variety of mechanisms to prevent overproduction of ppGpp and subsequent growth arrest.

Enzyme activities for RelA, SpoT, and RSH proteins are modulated to allow coordination of global transcription patterns in response to distinct nutrient stimuli, and it seems that the N-terminal and C-terminal domains of these proteins contribute to regulation of their activity in a variety of mechanisms. RelA is associated with the ribosome and synthesizes ppGpp in response to accumulation of uncharged (deacylated) tRNA in the ribosomal acceptor site (A-site) during amino acid starvation (Haseltine and Block, 1973; Ramagopal and Davis, 1974). RelA activation is dependent upon the proline-rich 36-amino acid N-terminal segment of L11, a 50S ribosomal protein (Friesen *et al.*, 1974; Yang and Ishiguro, 2001; Wendrich *et al.*, 2002). A proposed model for the mechanism of RelA-mediated ppGpp synthesis involves RelA detection of and binding to blocked ribosomes containing a 3' extension of mRNA, and the subsequent stimulation of RelA activity, which requires ribosomal protein L11 (Wendrich *et al.*, 2002). Upon ppGpp synthesis, RelA, but not the deacylated tRNA, is released from the ribosome, and data suggest that RelA moves from blocked ribosome to blocked ribosome which would correlate the amount of ppGpp synthesized to the number of blocked ribosomes within the cell (Wendrich *et al.*, 2002). Charged tRNAs have a much higher affinity for the acceptor site of the ribosome (Schilling-Bartetzko *et al.*, 1992) and, in post-starvation conditions, these charged tRNAs can easily replace the deacylated tRNAs, rescuing blocked ribosomes. Studies have indicated that bifunctional RSH proteins respond to amino acid starvation (Mechold *et al.*, 1996; Wendrich and Marahiel, 1997) and are

activated in a similar ribosome-dependent mechanism (Martinez-Costa *et al.*, 1998; Mechold *et al.*, 2002) with hydrolase activity decreasing significantly in the presence of uncharged tRNAs (Avarbock *et al.*, 2000).

The activities of RelA and bifunctional proteins are controlled through the C-terminal domains (CTD) of these proteins. CTD point mutations and deletions abolish activation of RelA in *E. coli* and the RSH homolog (Rel_{Mtb}) in *Mycobacterium tuberculosis* (Gropp *et al.*, 2001; Avarbock *et al.*, 2005). These studies have also demonstrated that the CTD is required for oligomerization of RelA and Rel_{Mtb}. This suggests a potential regulatory role for the CTD in relaying the activation signal from the ribosome to the N-terminal catalytic domain and that this signal transfer possibly involves oligomerization. Indeed, it has been proposed that the CTD could act as a regulator of ppGpp synthesis and may be controlled by ligand or protein binding (Mechold *et al.*, 2002).

SpoT has been implicated in responding to a variety of nutritional stresses, including fatty acid and carbon starvation. Several reports have demonstrated that the ppGpp hydrolase activity of SpoT cofractionates with the ribosome and is inhibited by uncharged tRNA (Heinemeyer and Richter, 1977; Sy, 1977; Richter, 1980) while a recent study found that SpoT copurifies with the 50S ribosomal subunit (Jiang *et al.*, 2007). In *E. coli*, a specific, physical interaction between SpoT and the acyl carrier protein (ACP), the central cofactor in fatty acid and lipid metabolism, has been characterized and implicated as a signal for SpoT-dependent ppGpp synthesis (Battesti and Bouveret, 2006). ACP interacts with the TGS (for “ThrRS, GTPase, and SpoT”) domain within the CTD domain of SpoT, and this binding may be influenced by the ratio of unacylated to

acylated ACP. However, the TGS domain does not determine the specificity of the interaction as this domain is highly conserved between SpoT and RelA. The N-terminal domain of RelA prevents interaction with ACP. The ACP and SpoT interaction was subsequently shown to be restricted to bacteria containing both RelA and SpoT and to ACPs encoded by genes located in fatty acid synthesis operons (Battesti and Bouveret, 2009), highlighting the diversity of ppGpp regulation and mechanisms in bacteria. The SpoT-ACP interaction was also shown to be necessary for *Legionella pneumophila* to respond to perturbations in fatty acid biosynthesis as a single amino acid substitution that is required for ACP interaction in SpoT (Battesti and Bouveret, 2006) eliminated SpoT-dependent ppGpp synthesis (Dalebroux *et al.*, 2009). A working model proposes that ACP relays the lipid metabolic state of the cell to SpoT and regulates the switch between SpoT-dependent ppGpp hydrolysis and synthesis activity.

The essential Obg (*spo0B*-associated GTP-binding protein) GTP-binding protein family (also known as CgtA (conserved GTPase) or YhbZ but will be referred to here as Obg for clarity) has recently been suggested to play a role in stringent response. Obg is important in sporulation in *Bacillus subtilis* (Kok *et al.*, 1994; Vidwans *et al.*, 1995) and morphological development in *Streptomyces coelicolor* (Okamoto and Ochi, 1998) and has been implicated in responding to DNA replication fork arrest in *E. coli* (Foti *et al.*, 2005). Obg proteins typically have high guanosine nucleotide exchange rates but relatively low GTP hydrolysis rates (Welsh *et al.*, 1994; Lin *et al.*, 1999). Several working models propose that rather than serve as GTPases, the nucleotide bound state of Obg proteins reflects the GDP:GTP ratio within the cell and ultimately affects general stress response and stationary phase survival (Okamoto and Ochi, 1998; Lin *et al.*, 1999;

Wout *et al.*, 2004). Interestingly, numerous studies have revealed that Obg cofractionates with the 50S ribosomal subunit and is required for ribosome assembly, stability and maturation (Scott *et al.*, 2000; Lin *et al.*, 2004; Wout *et al.*, 2004; Sato *et al.*, 2005; Sikora *et al.*, 2006), but this function may not be the cause for essentiality of Obg since ribosome assembly is not further impaired in a temperature sensitive allele of *Caulobacter crescentus* at the non-permissive temperature (Datta *et al.*, 2004). Most recently, Obg has been speculated to play a role in stringent response. Surprisingly, the crystal structure of Obg from *B. subtilis* was found to contain ppGpp (Buglino *et al.*, 2002). Obg in *E. coli* was shown to bind ppGpp in vitro with a similar affinity as GDP and alter the ratio of pppGpp to ppGpp within the cell during stringent response (Persky *et al.*, 2009). In *E. coli* and *V. cholerae*, Obg directly interacts with SpoT (Wout *et al.*, 2004; Raskin *et al.*, 2007) and affects ppGpp levels during exponential growth (Raskin *et al.*, 2007; Jiang *et al.*, 2007), suggesting that Obg promotes the ppGpp hydrolase activity of SpoT to maintain low ppGpp levels in normal growth conditions. However, Obg remains essential for cell growth in mutants that cannot synthesize ppGpp (Jiang *et al.*, 2007; Shah *et al.*, 2008) which has led to the speculation that Obg has a role on the output of the stringent response that is possibly ppGpp-independent (Persky *et al.*, 2009). Studies in *B. subtilis* have revealed interactions between Obg and several regulators necessary for activation of σ^B , the general stress sigma factor (Scott and Haldenwang, 1999) and have also determined that Obg and these σ^B regulators cofractionate with ribosomes (Scott *et al.*, 2000). The fact that SpoT in *E. coli* and the σ^B regulators in *B. subtilis* are ribosome associated suggests that the role of Obg proteins in stress response is coupled to their ribosome association. Finally, two different mutant alleles of Obg in

B. subtilis were discovered to exhibit separate effects for growth-promotion and for general stress response (Kuo *et al.*, 2008), clarifying that other phenotypes attributed to Obg deficiencies are not indirect consequences of the underlying growth defects but are rather direct regulation by Obg. Altogether, these data indicate a complex model in which Obg activity is possibly regulated by guanosine nucleotide interaction and subsequently plays a role in regulating ppGpp metabolism, stress response and ribosome biogenesis.

DksA, a cofactor for ppGpp regulation

An additional mediator of stringent response, DksA (DnaK suppressor A), was first discovered as a multicopy suppressor of the temperature sensitive growth and filamentous phenotypes of a *dnaK* (encoding Hsp70) mutant (Kang and Craig, 1990). Since then, DksA has been associated with many pleiotropic effects within the cell, producing profound changes in amino acid biosynthesis (Kang and Craig, 1990), cell division (Yamanaka *et al.*, 1994; Ishii *et al.*, 2000), quorum sensing (Branny *et al.*, 2001) and virulence (Webb *et al.*, 1999; Mogull *et al.*, 2001). Eventually, DksA was demonstrated to affect ppGpp-mediated regulation of RpoS (Brown *et al.*, 2002). Further studies revealed that DksA is necessary for the stringent response and augments ppGpp regulation for both the inhibition of rRNA transcription (Paul *et al.*, 2004a) and the activation of amino acid biosynthetic promoters (Paul *et al.*, 2005). The discovery of a ppGpp cofactor resolved the long-standing discrepancy in the field where the extremely strong effects of ppGpp on transcription of target promoters *in vivo* were not reproducible *in vitro*.

DksA binds within the secondary channel of RNA polymerase (Perederina *et al.*, 2004; Rutherford *et al.*, 2007) which is both the entry point for nucleotide triphosphate precursors (NTPs) and the exit point for backtracked RNA. X-ray crystallography of DksA revealed a coiled-coil motif with two highly conserved, aspartic acids (Asp) at the finger tip (Vassilyeva *et al.*, 2004; Perederina *et al.*, 2004) that are required for DksA function (Perederina *et al.*, 2004). The DksA structure is related to that of GreA and GreB, although they share no sequence homology (Perederina *et al.*, 2004). GreA and GreB are transcription elongation factors that rescue arrested RNA polymerases by cleaving backtracked RNA and restoring a transcription complex that is able to continue RNA synthesis (Hsu *et al.*, 1995). The Gre factors contain two conserved acidic residues, similar to DksA, at the finger tip, and these coordinate a Mg^{2+} ion required for hydrolysis of the backtracked RNA (Laptenko *et al.*, 2003); however, DksA does not possess enzymatic activity. While DksA and the Gre factors display independent and even antagonistic functions *in vivo* (Potrykus *et al.*, 2006), there have been indications that there are common effects of protein binding within the secondary channel because GreB can replace DksA for stringent regulation of rRNA promoters *in vitro*; however, the low concentration of GreB prevents any measureable effects *in vivo*, and GreB is unable to rescue activation of transcription nor rescue the ability of RNAP lacking the ω subunit to respond to ppGpp (see below) (Rutherford *et al.*, 2007).

In studies that were designed to gain insight into DksA function, random mutagenesis of *dksA* revealed two independent mutations that were able to restore growth of a *relA spoT dksA* triple mutant on minimal media (Blankschien *et al.*, 2009). These mutations, N88I and L15F, were able to increase DksA activity *in vivo* and bypass the

requirement for ppGpp. These mutants result in shorter half-lives for open complex formation between RNAP and promoters and bind more tightly to RNAP than wild-type DksA. This study, along with a report that DksA has higher affinity for free RNAP versus RNAP in an open complex formation with DNA (Lennon *et al.*, 2009), suggests that the affinity of DksA to RNAP plays a role in its function. The super DksA mutants also identify putative surface areas of DksA that might interact with RNAP.

Mechanism of ppGpp and DksA

Originally, identification of suppressors of *relA spoT* double mutants (also known as ppGpp⁰ mutant) in *E. coli* provided insights into the role of ppGpp function (Hernandez and Cashel, 1995; Bartlett *et al.*, 1998; Barker *et al.*, 2001a; Murphy and Cashel, 2003; Trautinger and Lloyd, 2002; Szalewska-Palasz *et al.*, 2007). The majority of suppressors mapped to *rpoBC*, the genes that encode β and β' subunits of RNAP. These mutations destabilized promoter-RNAP interactions, mimicking the stringent response. Similar results were obtained with *dksA* mutants, suggesting that DksA hinders the conformational changes in RNAP and DNA during the transition to the open complex intermediate (Rutherford *et al.*, 2009). Meanwhile, ppGpp and DksA have been demonstrated to directly interact with RNA polymerase and influence transcription in a promoter-dependent mechanism (Barker *et al.*, 2001b; Paul *et al.*, 2004a). ppGpp and DksA reduce the half-life of the open complex of promoters with RNAP, in turn, inhibiting transcription from promoters that already have intrinsically short-lived open complexes (e.g. rRNA promoters) (Zhou and Jin, 1998; Barker *et al.*, 2001b; Paul *et al.*, 2004a). Promoters that have long-lived open complexes are presumably not negatively

affected by ppGpp and DksA because RNAP clears the promoter before dissociation occurs. Negatively regulated promoters are characterized by the presence of a GC-rich discriminator sequence located between the -10 and the transcription start site and suboptimal sequences for sigma factor recognition (Travers, 1980; Travers, 1984; Josaitis *et al.*, 1995; Park *et al.*, 2002; Haugen *et al.*, 2006). Importantly, DksA reduces the lifetimes of open complexes even in the absence of ppGpp, indicating that DksA can function independently of ppGpp (Paul *et al.*, 2004a). However, DksA protein levels remain constant in all conditions tested (Paul *et al.*, 2004a; Rutherford *et al.*, 2007), supporting the hypothesis that the varying concentrations of ppGpp and initiating NTPs are the modulators of rRNA transcription (Murray *et al.*, 2003; Dalebroux *et al.*, 2010).

The positive effects of ppGpp and DksA most likely occur in both direct and indirect mechanisms. While ppGpp and DksA are responsible for directly activating transcription of some amino acid promoters by increasing the isomerization rate constant (k_i) on the pathway to open complex formation (Paul *et al.*, 2005), some of these promoters are possibly activated indirectly. One hypothesis suggests that the concentration of free RNAP can be increased by reducing that amount of RNAP involved in transcription of stable RNA promoters (Barker *et al.*, 2001a; Paul *et al.*, 2005). In support, positively regulated promoters that are activated indirectly have low affinity for RNAP and require high concentrations of RNAP *in vitro* (Barker *et al.*, 2001a). Additionally, increased levels of free core RNAP could also allow competition by alternative sigma factors (e.g. σ^S , σ^E , σ^N , *etc.*), indirectly promoting alternative sigma factor-dependent gene regulation (Jishage *et al.*, 2002). One study demonstrated that RpoS-dependent promoters are not efficiently transcribed in a ppGpp⁰ strain, even in the

presence of high concentrations of RpoS, perhaps because of a reduction of free RNAP core in the absence of ppGpp (Kvint *et al.*, 2000). Several studies have presented evidence that ppGpp and/or DksA are required for alternative sigma factor-dependent transcription *in vivo* and have also shown that mutations in RNAP that mimic the stringent response allow for efficient sigma factor competition in the absence of ppGpp accumulation (Jishage *et al.*, 2002; Laurie *et al.*, 2003; Bernardo *et al.*, 2006; Szalewska-Palasz *et al.*, 2007; Costanzo *et al.*, 2008), suggesting that the stringent response employs both direct and indirect mechanisms to alter global transcription.

Although there is direct evidence that ppGpp and DksA can inhibit or activate transcription from target promoters, the exact molecular mechanism remains unclear. It is thought that ppGpp could increase DksA activity, that ppGpp and DksA work cooperatively to induce common conformational changes in RNAP, or that each factor induces different conformational changes in RNAP that are synergistic (Blankschien *et al.*, 2009). Cocrystal structures of the *Thermus thermophilus* RNA polymerase-ppGpp complex determined that ppGpp binds in two different orientations near the active site (Artsimovitch *et al.*, 2004). However, this structural data was challenged by a study that systematically made amino acid substitutions in ten residues that were near the putative ppGpp binding site and found no effect in ppGpp-mediated regulation (Vrentas *et al.*, 2008). Furthermore, *T. thermophilus* RNA polymerase does not respond to ppGpp directly *in vitro* (Vrentas *et al.*, 2008) or *in vivo* (Kasai *et al.*, 2006), suggesting an indirect mechanism for stringent control, similar to *B. subtilis* (see below).

Finally, the ω subunit of RNAP has been implicated in stringent response. First, the ω subunit plays a structural role in assembly of RNAP. ω aids the proper folding of

the β' subunit and directs the association of β' with the $\alpha_2\beta$ subunits (Gentry and Burgess, 1993; Mukherjee *et al.*, 1999; Ghosh *et al.*, 2001). Encoded in the same operon as *spoT* (Gentry and Burgess, 1989), an initial study concluded that the ω protein was required for RNAP sensitivity to ppGpp in vitro (Igarashi *et al.*, 1989) while another study demonstrated that it was not necessary for stringent response in vivo (Gentry *et al.*, 1991). Further studies revealed that RNAP could regain sensitivity to ppGpp in vitro upon the addition of ω , indicating that ω is needed for an appropriate response to ppGpp by RNAP (Vrentas *et al.*, 2005). The discrepancy between the in vivo and in vitro studies was resolved upon the discovery that DksA can rescue RNAP sensitivity to ppGpp in the absence of the ω subunit in vitro (Vrentas *et al.*, 2005). This most likely accounts for the ability of *rpoZ* mutants to retain sensitivity to ppGpp in vivo; however, more studies are needed to further elucidate the role that ω has on the ppGpp-responsiveness of RNAP.

Interestingly, *B. subtilis* and *T. thermophilus* employ a different mechanism for ppGpp regulation than *E. coli* and other γ -proteobacteria. In *B. subtilis*, ppGpp does not directly inhibit rRNA promoters; instead, synthesis of ppGpp depletes the intracellular pools of GTP, reducing the concentration of the initiating NTP for all rRNA promoters (Krasny and Gourse, 2004). In agreement with this hypothesis, there is no longer a ppGpp-dependent reduction of transcription when the initiating nucleotide of rRNA promoters is mutated from the native G (Krasny and Gourse, 2004). ppGpp also reduces the synthesis of GTP by inhibiting inosine monophosphate (IMP) dehydrogenase, the enzyme that catalyzes the first reaction toward GTP biosynthesis (Lopez *et al.*, 1981; Ochi *et al.*, 1982; Ochi, 1987; Kasai *et al.*, 2006). Although ppGpp strongly inhibits IMP

dehydrogenase in *E. coli* (Gallant *et al.*, 1971), many of the rRNA operons initiate transcription with ATP, making these promoters insensitive to changes in the GTP pool (Gaal *et al.*, 1997). However, direct interaction of ppGpp with RNAP associated with rRNA promoters apparently allows efficient regulation in *E. coli*. Importantly, there are no homologs in *B. subtilis* with strong homology to DksA, supporting the hypothesis that ppGpp regulation is indirect (Krasny and Gourse, 2004).

An additional factor involved in the stringent response of *B. subtilis* and other low G+C Gram-positive bacteria is CodY, a DNA-binding transcriptional repressor (Serror and Sonenshein, 1996b). The CodY regulon encompasses operons that regulate sporulation (Molle *et al.*, 2003) and competence (Serror and Sonenshein, 1996a) and that are involved in branched-chain amino acid (BCAA) synthesis (Molle *et al.*, 2003). CodY is directly activated by GTP (Ratnayake-Lecamwasam *et al.*, 2001; Handke *et al.*, 2008) and the BCAAs, isoleucine and valine (Shivers and Sonenshein, 2004). Activity of CodY has been correlated with ppGpp levels in several organisms, in that many CodY-repressed genes are transcribed following RelA activation, ppGpp synthesis and the reduction of intracellular GTP concentrations (Inaoka and Ochi, 2002; Malke *et al.*, 2006; Lemos *et al.*, 2008). These studies indicate that CodY is a global sensor that responds to intracellular levels of GTP which reflect nutritional limitations and allow for complete alteration of global transcription.

Regulatory targets of ppGpp and DksA

The effects of ppGpp and DksA on bacterial physiology are quite broad. In early studies, the stringent response was linked to growth rate control (Bremer and Dennis,

1996). Here, basal level changes of ppGpp, not NTP substrate concentrations as previously thought, are inversely correlated with growth rate and the number of ribosomes per cell (Schneider and Gourse, 2004). In addition to regulating metabolic processes, ppGpp and DksA are responsible for regulating a number of cellular processes involved in survival under various environmental stresses and also play a role in colonization and virulence in pathogenic bacteria.

In *E. coli*, the stringent response induces expression of the stationary phase sigma factor, RpoS (Gentry *et al.*, 1993), and both ppGpp and DksA appear to exert effects at multiple levels. Transcription of *rpoS* depends upon ppGpp (Lange *et al.*, 1995). Further studies revealed that ppGpp has an effect on basal expression of *rpoS*, although there is a slight delay in *rpoS* expression in a ppGpp⁰ strain (Hirsch and Elliott, 2002). DksA is also necessary for the ppGpp-dependent activation of *rpoS* at the translational level; however, it is unknown if this is direct or indirect (Brown *et al.*, 2002; Hirsch and Elliott, 2002). ppGpp also controls RpoS protein stability. During phosphate starvation, SpoT-derived ppGpp positively regulates *iraP* transcription, which encodes an anti-adaptor protein that inhibits proteolysis of RpoS by interfering with the RssB-specific targeted degradation by ClpXP (Bougdour and Gottesman, 2007). Another RpoS anti-adaptor protein, IraD, is also transcriptionally upregulated by ppGpp and requires both RelA and SpoT synthetase activities (Merrikh *et al.*, 2009).

Recent data suggest that ppGpp and DksA can function independently and even antagonistically. An initial study revealed that while ppGpp activated the expression of type 1 fimbriae in uropathogenic *E. coli*, expression was increased in the absence of DksA (Aberg *et al.*, 2008). Further analysis of *fimB* and other similarly regulated targets

identified via microarray studies, including targets important for flagellum synthesis and chemotaxis, demonstrated that the increased access of the Gre factors to the secondary channel of RNAP was responsible for the upregulation of expression (Aberg *et al.*, 2008; Aberg *et al.*, 2009). In fact, strains lacking both GreA and GreB along with DksA no longer exhibited an increase in *fimB* expression (Aberg *et al.*, 2008). In contrast to the in vivo results, ppGpp and DksA exhibit the same inhibitory effect in vitro (Aberg *et al.*, 2008). Because GreA and GreB are present in very low concentrations compared to DksA (Rutherford *et al.*, 2007), the ability for the Gre factors to effectively compete for binding to the secondary channel of RNAP in the presence of DksA is questionable; however, these studies suggest that the competition for occupancy of the secondary channel potentially plays a role in transcriptional regulation.

Other studies have found opposing effects of ppGpp and DksA in *E. coli*. One study found that DksA is required for upregulation of the λ pR promoter both in vivo and in vitro while ppGpp represses expression (Lyzen *et al.*, 2009). Because the effect of DksA is positive in this case, the Gre factors likely do not play a role. Transcription of *iraD*, mentioned above, is positively regulated by ppGpp but is repressed by DksA (Merrikh *et al.*, 2009). While these studies are intriguing, more work is needed to clarify how ppGpp and DksA exhibit antagonistic and independent effects at the same promoter and whether these effects are physiologically relevant.

In addition to effects mediated on transcriptional and post-transcriptional levels, ppGpp and DksA influence DNA replication during amino acid starvation (Levine *et al.*, 1991). In *B. subtilis*, ppGpp inhibits replication elongation by directly inhibiting primase, an essential component of the replication machinery, and reducing the ability to recruit

RecA to replication forks (Wang *et al.*, 2007). In *E. coli*, ppGpp blocks replication initiation and appears to also prevent chromosome segregation; these effects require both Dam and SeqA (Ferullo and Lovett, 2008). Independently of ppGpp, DksA, along with GreA, GreB and TraR, inhibits stalled transcription complexes from interfering with replication, likely by promoting transcriptional elongation (Tehranchi *et al.*, 2010). As previously mentioned, *B. subtilis* does not contain a DksA homolog and appears to resolve the conflict between transcription and replication through genome organization by having a high percentage of genes codirectionally transcribed and replicated (Rocha, 2004; Srivatsan *et al.*, 2010). *B. subtilis* and *E. coli* utilize the stringent response through different mechanisms to coordinate nutritional status and other stresses with DNA replication and protect the genome from possible DNA damage.

Regulation of biofilm formation and c-di-GMP

A biofilm is an aggregate of bacteria that is encased in a matrix composed primarily of exopolysaccharides and may contain proteins and extracellular DNA (Costerton, 1995). The formation of biofilms is distinct from motile, planktonic cells, and the phenotypes of biofilm and planktonic cells are vastly different. 3',5'-cyclic diguanylic acid (c-di-GMP) has been characterized as a nearly ubiquitous second messenger that plays a role in regulation of several physiological processes, including signaling the transition between sessility and motility. c-di-GMP was originally discovered as a modified nucleotide that allosterically activates cellulose synthase in *Gluconacetobacter xylinus* (formerly *Acetobacter xylinus*; Ross *et al.*, 1987). Since then, c-di-GMP has been implicated in promoting synthesis of adhesions and

exopolysaccharide matrix components (reviewed in Jonas *et al.*, 2009), inhibiting motility (reviewed in Wolfe and Visick, 2008), controlling long-term survival (Kumar and Chatterji, 2008) and response to environmental stresses (Klebensberger *et al.*, 2009; Guo and Rowe-Magnus, 2010), as well as regulating virulence (reviewed in Cotter and Stibitz, 2007), synthesis of secondary metabolites (Fineran *et al.*, 2007) and cell cycle progression (Duerig *et al.*, 2009).

Metabolism of c-di-GMP

c-di-GMP is synthesized from two molecules of GTP by diguanylate cyclases (DGCs) and degraded to linear pGpG or GMP by phosphodiesterases (PDEs). GGDEF domains possess DGC activity (Ausmees *et al.*, 2001; Paul *et al.*, 2004b; Ryjenkov *et al.*, 2005) while PDE activity is conferred by either the EAL (Bobrov *et al.*, 2005; Schmidt *et al.*, 2005) or the HD-GYP domains (Ryan *et al.*, 2006). These motifs, named for their conserved amino acids, are critical for DGC and PDE activity. Frequently, c-di-GMP metabolizing proteins contain sensory and signal transduction domains (e.g. CheY-like (REC), PAS and GAF; Hecht and Newton, 1995; Aravind and Ponting, 1999; Galperin *et al.*, 2001), which may allow activity to be regulated through environmental signals (Jenal and Malone, 2006; see below).

PleD, an unusual response regulator required for pole development in *Caulobacter crescentus*, was the first GGDEF domain protein that was characterized biochemically to contain DGC activity (Paul *et al.*, 2004b). A crystal structure revealed that PleD forms a dimer with a c-di-GMP molecule binding to each aligned GGDEF domain (Chan *et al.*, 2004), and subsequent studies indicated that phosphorylation-

mediated dimerization via the CheY-like phosphoacceptor (or receiver [REC]) domains is necessary for catalytic activity of PleD (Paul *et al.*, 2007; Wassmann *et al.*, 2007).

However, some DGC proteins are not dependent upon phosphorylation for regulatory control. WspR from *P. aeruginosa* switches from inactive to active states through an intermediate tetrameric form via non-modified REC domains (De *et al.*, 2008). Recent observations suggest that DgcA and DgcB from *C. crescentus* are permanent dimers and are constitutively active (Schirmer and Jenal, 2009), highlighting a variety of mechanisms for DGC activation and regulation.

The PleD and DgcA crystal structures revealed an additional binding site (I-site) for c-di-GMP, allowing for allosteric noncompetitive product inhibition of DGC activity (Chan *et al.*, 2004; Christen *et al.*, 2006). Additional experiments defined an RXXD binding motif within the GGDEF domain (Christen *et al.*, 2006). This motif is highly conserved within many characterized and predicted GGDEF domain proteins (Christen *et al.*, 2006), suggesting that this mechanism of feedback inhibition is important for regulatory control of c-di-GMP synthesis. An additional mode of feedback inhibition entails c-di-GMP-mediated crosslinking between each DGC domain within the dimer, resulting in dimer immobilization (Wassmann *et al.*, 2007; De *et al.*, 2009).

Several observations hinted that the EAL domain may possess PDE activity (Tal *et al.*, 1998; Galperin *et al.*, 1999; Chang *et al.*, 2001), and in vivo experiments indicated that this domain was responsible for repressing biofilm formation in *V. cholerae* (Tischler and Camilli, 2004) and for reducing c-di-GMP levels in *Salmonella* (Simm *et al.*, 2004). Subsequently, purified EAL domains and intact proteins were demonstrated to possess PDE activity (Christen *et al.*, 2005; Schmidt *et al.*, 2005; Bobrov *et al.*, 2005; Tamayo *et*

al., 2005). In addition to the conserved EAL domain, an extended motif (DDFG(T/A)GYSS) that forms a conserved loop (known as loop 6) is important for dimerization of EAL domain proteins and for c-di-GMP binding (Rao *et al.*, 2008; Rao *et al.*, 2009). Interestingly, sequence analysis revealed that approximately half of the known EAL domain proteins contain a degenerate loop, suggesting that two classes of EAL domain proteins may exist (Rao *et al.*, 2009; Romling, 2009).

HD-GYP domain proteins are part of the HD superfamily of metal-dependent phosphohydrolases and were hypothesized to function as phosphodiesterases because of the association of the HD-GYP domain with the GGDEF domain (Galperin *et al.*, 1999; Galperin *et al.*, 2001). Additionally, several species, most notably *Thermatoga maritima*, were found to contain numerous GGDEF domains, but no EAL domains, suggesting that these bacteria could contain phosphodiesterase activity mediated by an alternative domain (Galperin *et al.*, 1999). The first example of the HD-GYP domain as a c-di-GMP phosphodiesterase was from *Xanthomonas campestris* pv. *campestris*, a plant pathogen responsible for black rot (Ryan *et al.*, 2006). An isolated HD-GYP domain degraded c-di-GMP to GMP via a linear pGpG substrate, and mutation of the conserved HD residues eliminated the regulatory and enzymatic activities of the protein (Ryan *et al.*, 2006). Subsequent studies have revealed that the phosphodiesterase activity of HD-GYP domain proteins is required for quorum sensing-mediated biofilm production in *V. cholerae* El Tor (Hammer and Bassler, 2009) and for the synthesis and/or secretion of virulence factors and swarming capabilities of *P. aeruginosa* (Ryan *et al.*, 2009). In addition, the GYP residues have been shown to play a role in a physical interaction with a subset of

GGDEF domain proteins in *X. campestris*, influencing pilus-dependent motility (Ryan *et al.*, 2010).

Although these three characterized domains can occur separately, they are frequently found as composite proteins containing both GGDEF and EAL or HD-GYP domains. Bifunctional enzymes, reminiscent of SpoT and RSH proteins, can possess DGC and PDE activities. The regulation of DGC versus PDE activity can be constitutive (Tarutina *et al.*, 2006), regulated by accessory proteins (Ferreira *et al.*, 2008), or demonstrate both enzymatic events simultaneously (Kumar and Chatterji, 2008). There are also a number of GGDEF-EAL composite proteins that contain degenerative GGDEF and/or EAL domains. The best characterized example, PdeA from *C. crescentus*, possesses a degenerative GGDEF domain that lacks DGC activity but is able to increase PDE activity through an allosteric mechanism of sensing GTP availability (Christen *et al.*, 2005). The *V. cholerae* CdpA appears to function similarly as the GGDEF domain is necessary for PDE activity *in vivo* (Tamayo *et al.*, 2008). Supporting the above studies, computational genomics revealed that there are predominantly two classes of composite proteins: those that contain conserved GGDEF and EAL domains and are possibly regulated by an additional domain and those that only possess an intact EAL domain that is typically associated with a signal-sensing domain (Seshasayee *et al.*, 2010).

Some recently characterized GGDEF-EAL domain proteins lack both DGC and PDE activity and have adopted other roles. The crystal structure of FimX, a degenerate GGDEF-EAL protein that regulates twitching motility and biofilm in *P. aeruginosa*, revealed that FimX is capable of interacting with c-di-GMP within the EAL domain (Navarro *et al.*, 2009). This study suggests that c-di-GMP sensing through degenerate

GDDEF and EAL domains may provide additional regulatory mechanisms beyond c-di-GMP metabolism (see below). Indeed, CsrD, a specificity factor necessary for the turnover of CsrB and CsrC sRNAs, was the first GGDEF-EAL domain protein assigned a function not involving c-di-GMP metabolism (Suzuki *et al.*, 2006), providing a possible explanation for the large number of GGDEF and/or EAL domain proteins found in some species.

The number of encoded GGDEF and/or EAL domain proteins is highly variable among various eubacteria (Galperin *et al.*, 2001). A few species have none or few while *E. coli* and other γ -proteobacteria contain a large number of GGDEF and/or EAL domain proteins (Galperin *et al.*, 2001). It is surprising that a single species would possess multiple proteins containing the same enzymatic activities since most appear to retain catalytic activity and thus be involved in c-di-GMP signaling. This high redundancy could tightly control c-di-GMP levels in response to a variety of conditions and, thus, raises questions about how the specificity of the signal is achieved and how the cell could avoid cross-talk. Do different GGDEF/EAL domain proteins act independently and affect different targets or do all of the proteins control a common, diffusible pool of c-di-GMP? Recent studies have suggested that not all of the GGDEF and EAL domain proteins are present and active at the same time and in the same place.

Temporal regulation of expression and activity of GGDEF and/or EAL domain proteins in a variety of organisms allows c-di-GMP regulation to occur only under specific conditions. In *E. coli*, only a few GGDEF and/or EAL domain proteins are expressed during exponential growth while the majority of these are expressed during stationary phase under the control of the stationary sigma factor, σ^S (Sommerfeldt *et al.*,

2009). Several GGDEF and/or EAL domain-encoding genes in *V. cholerae* are regulated by cAMP-CRP (Fong and Yildiz, 2008) and the quorum-sensing regulator HapR (Waters *et al.*, 2008). In *Yersinia pestis*, the GGDEF domain protein HmsT is degraded by ClpXP and Lon proteases (Kirillina *et al.*, 2004).

In addition to transcriptional and post-translational mechanisms of regulation, GGDEF and EAL domain proteins are regulated post-transcriptionally by CsrA in *E. coli* and *Salmonella* Typhimurium. CsrA directly represses the expression of two GGDEF domain proteins, YcdT and YdeH, in *E. coli*, preventing accumulation of c-di-GMP (Chapter 3). In *Salmonella* Typhimurium, CsrA plays a complex role in directly and indirectly mediating the expression of eight GGDEF and/or EAL domain proteins, generally promoting motility and downregulating biofilm formation (Chapter 4).

Additionally, bioinformatics data suggest that the activities of DGCs and PDEs may be frequently regulated by associated accessory domains, which allow the integration of environmental and cellular signals. A comparative genomics study found that over half of the identified GGDEF and EAL domain proteins contain an additional domain (Seshasayee *et al.*, 2010). The oxygen-sensing PAS and blue-light sensing BLUF domains have been suggested to regulate PDE activity of EAL domain proteins in *G. xylinus* (Chang *et al.*, 2001; Qi *et al.*, 2009), *B. subtilis* (Minasov *et al.*, 2009), *Klebsiella pneumoniae* (Wu and Gardner, 2009; Barends *et al.*, 2009) and *E. coli* (Hasegawa *et al.*, 2006; Schroeder *et al.*, 2008). However, the YcgF protein in *E. coli* that contains an EAL domain associated with a BLUF domain does not function as a c-di-GMP phosphodiesterase, but instead serves as an anti-repressor, releasing the transcriptional repressor YcgE in response to blue-light irradiation (Tschowri *et al.*,

2009). In addition to the regulatory function of the REC domain of PleD in dimerization (Paul *et al.*, 2004b; Wassmann *et al.*, 2007), the REC domain is important for two-component and phosphorelay signaling pathways. For example, the *V. cholerae* EAL domain protein and transcription factor, VieA, contains a REC domain that activates transcription of the *vieSAB* operon upon phosphorylation by VieS, creating a positive feedback loop that increases the concentration of VieA and, potentially, PDE activity (Martinez-Wilson *et al.*, 2008). The REC domain also appears to be necessary for localization of certain GGDEF and EAL domain proteins to the cell poles (Paul *et al.*, 2004b; Kazmierczak *et al.*, 2006; Guvener and Harwood, 2007). Some GGDEF and EAL proteins contain multiple sensory domains, suggesting that complex signal integration may be involved in the regulation of these proteins.

Several reports suggest that some of the GGDEF and/or EAL domain proteins can be functionally sequestered (reviewed in Hengge, 2009, Jonas *et al.*, 2009), allowing c-di-GMP signaling to occur within “microcompartments” of the cell. Recent data suggest that specific protein-protein interactions between GGDEF domains and EAL and HD-GYP domains can occur (Andrade *et al.*, 2006; Bobrov *et al.*, 2008), perhaps allowing local confinement of c-di-GMP signaling. Functional sequestration also includes spatial separation, exemplified by the extensively characterized cell cycle of *C. crescentus*, which requires the localization of specific DGCs, PDEs and a newly identified effector protein for cell cycle progression (Paul *et al.*, 2004b; Huitema *et al.*, 2006; Duerig *et al.*, 2009).

Regulation by c-di-GMP

The production of c-di-GMP allows for a quickly synthesized signal to interact with downstream targets to relay environmental cues. c-di-GMP regulation occurs on multiple levels including transcriptional, translational and posttranslational mechanisms. The first enzyme shown to directly bind c-di-GMP and undergo allosteric activation was cellulose synthase of *G. xylinus* (BscA) (Ross *et al.*, 1987; Weinhouse *et al.*, 1997). Subsequently, the PilZ domain was suggested to interact with c-di-GMP through a bioinformatics analysis that revealed PilZ domains were sometimes found C-terminally of GGDEF and EAL domain proteins and have a similar phyletic distribution as GGDEF and EAL domain proteins (Amikam and Galperin, 2006). In addition, this study revealed that the cellulose synthase of *G. xylinus* contains a putative PilZ domain, providing evidence that the PilZ domain is a c-di-GMP receptor. The PilZ domain protein YcgR of *E. coli* was found to directly bind c-di-GMP stoichiometrically (Ryjenkov *et al.*, 2006), confirming that the PilZ domain is a conserved c-di-GMP-binding domain. Subsequent studies have shown that PilZ domain proteins play a broad regulatory role in biofilm, motility and virulence (Pratt *et al.*, 2007; Merighi *et al.*, 2007; Christen *et al.*, 2007; Ramelot *et al.*, 2007). It appears that PilZ domain proteins may function primarily through protein-protein interactions. Structural studies have revealed that various PilZ domain proteins exhibit different c-di-GMP binding stoichiometry and quaternary structure (Ramelot *et al.*, 2007; Benach *et al.*, 2007; Ko *et al.*, 2010).

The PilZ domain protein YcgR was recently hypothesized to inhibit motility by interfering with the flagellum switch complex, a structure located at the base of the flagellum (Wolfe and Visick, 2008). Indeed, YcgR was discovered to directly interact

with FliG subunit of the switch complex, and the affinity for YcgR binding to FliG was increased upon binding to c-di-GMP (Paul *et al.*, 2010; Fang and Gomelsky, 2010). This interaction biases flagellar rotation to the counter-clockwise direction (Paul *et al.*, 2010; Fang and Gomelsky, 2010). However, another study reported that YcgR interacts with the motor protein MotA in response to c-di-GMP binding and that a gradient of c-di-GMP levels affects swimming velocity (Boehm *et al.*, 2010). While more studies are required to eliminate these inconsistencies, both studies reveal that YcgR negatively influences motility upon c-di-GMP binding.

A PilZ domain protein could not be attributed to a c-di-GMP-dependent phenotype of PEL polysaccharide production in *P. aeruginosa*, suggesting that another c-di-GMP-sensing domain might mediate c-di-GMP effects. PelD, encoded in the *pel* operon, was found to directly bind c-di-GMP. Binding of c-di-GMP required an RxxD motif, similar to the I-site of the GGDEF domain protein PleD of *C. crescentus* (Lee *et al.*, 2007). PEL synthesis requires binding to c-di-GMP to PelD, perhaps functioning, in turn, as an allosteric activator, similar to the PilZ domain of the BscA1 protein in *G. xylinus*. Other than PelD homologs in closely related bacteria, it appears that no other proteins contain the PelD domain for c-di-GMP binding (Lee *et al.*, 2007).

To determine the mechanism of c-di-GMP effects on motility in *P. aeruginosa*, analysis of transcriptional regulation of flagellum biosynthesis operons was investigated. These studies revealed that FleQ, the master regulator of flagella gene expression and repressor of exopolysaccharide (EPS) biosynthesis operons, directly bound to c-di-GMP (Hickman and Harwood, 2008). Cyclic-di-GMP binding to FleQ relieves transcriptional repression of the EPS operons, upregulating biofilm formation (Hickman and Harwood,

2008). Perhaps c-di-GMP binding promotes a conformational change in FleQ, reducing DNA binding. Interestingly, c-di-GMP binding did not have a significant effect on positively regulated promoters, suggesting that the mechanisms for FleQ activation and repression differ. Further studies are needed to elucidate the FleQ regulon and other potential c-di-GMP regulatory targets.

Transcriptional regulators may be a common target for c-di-GMP signaling. The cAMP receptor-like protein (CLP) in *X. campestris* is no longer able to interact with DNA when bound by c-di-GMP (Chin *et al.*, 2010). The proposed c-di-GMP binding site of this protein has limited similarity to the RxxD motif (Chin *et al.*, 2010), and further analysis is required to determine if CLP contains a novel c-di-GMP binding motif. VpsT of *V. cholerae* contains a unique, conserved c-di-GMP binding site and undergoes a conformational change upon c-di-GMP binding that is required for DNA binding (Krasteva *et al.*, 2010). The latter study also demonstrated that VpsT inversely coordinates biofilm and motility in a c-di-GMP-dependent mechanism (Krasteva *et al.*, 2010).

Degenerate GGDEF and EAL domains have been hypothesized to serve as c-di-GMP receptors. LapD, an inner membrane protein that functions as a c-di-GMP effector in *P. aeruginosa*, relays intracellular c-di-GMP levels to the membrane localized attachment machinery required for biofilm formation (Newell *et al.*, 2009). Here, c-di-GMP binds the degenerate EAL domain of LapD, creating a signal that is transferred through the periplasmic domain to control biofilm formation via the cell surface adhesin LapA (Newell *et al.*, 2009). In *V. cholerae*, a degenerate GGDEF domain protein, CdgG,

contains a conserved I-site (the RxxD motif) that is essential for its function, indicating that this motif may interact with c-di-GMP (Beyhan *et al.*, 2008).

Recently, PopA, a PleD paralog in *C. crescentus* that contains a degenerate GGDEF motif, was demonstrated not to possess DGC activity, but to bind c-di-GMP at the conserved I-site (RxxD motif) (Duerig *et al.*, 2009). The binding of c-di-GMP sequesters PopA at the cell pole where it recruits the replication initiation inhibitor CtrA and proteases of CtrA to positively regulate cell cycle progression (Duerig *et al.*, 2009). This finding established a novel role for c-di-GMP in regulation.

Interestingly, c-di-GMP can serve as a ligand for a highly conserved RNA motif, GEMM, which functions as a riboswitch (Sudarsan *et al.*, 2008). Bioinformatic searches determined that this riboswitch paradigm is present in a variety of organisms, including in the genome of a bacteriophage, and suggested that the c-di-GMP regulon could include riboswitch regulation of pilus formation, flagellum biosynthesis and virulence gene expression (Sudarsan *et al.*, 2008). A recent study describes a second class of riboswitches in *Clostridium difficile* which regulates a cis-encoded ribozyme (Lee *et al.*, 2010). c-di-GMP binding to the riboswitch alters RNA processing by the ribozyme, allowing for translation of the downstream gene (Lee *et al.*, 2010). These findings have mechanistic implications for additional roles of c-di-GMP as a secondary messenger by exerting effects on anti-termination or translation control.

Interestingly, in *Staphylococcus epidermidis* and other representatives of *Firmicutes*, only one conserved and one modified GGDEF domain proteins are encoded, and no EAL /HD-GYP domain nor PilZ domain proteins are present (Amikam and Galperin, 2006). Furthermore, one study found that the conserved GGDEF domain

protein of *S. epidermidis* appears to regulate biofilm formation in a c-di-GMP-independent fashion (Holland *et al.*, 2008). This study suggests that the physiological roles of GGDEF domain proteins may be conserved while the precise molecular mechanism may vary greatly.

Global regulatory networks and global regulons in prokaryotes

Global regulatory systems allow the conversion of extracellular cues and environmental signals to defined responses by the bacterium. These responses create global changes in gene expression and permit the bacteria to survive conditions of nutritional starvation and environmental stress. Recent advances in transcriptomics and proteomics have allowed computational and systems biology approaches to produce comprehensive models of regulatory networks and interactions in *E. coli* (Barabasi and Oltvai, 2004; Gama-Castro *et al.*, 2008).

Global regulatory networks have traditionally been characterized at the transcriptional level. The role that other types of regulators perform in global regulatory networks has not been thoroughly studied, but it is clear that post-transcriptional, translational and post-translational regulators influence gene expression on a global level. Two post-transcriptional regulators, Hfq and CsrA, have been discovered to participate in regulatory circuits containing transcription factors (Beisel and Storz, 2010; Suzuki *et al.*, 2002). Hfq and CsrA also utilize sRNAs for their regulatory processes; Hfq is an RNA chaperone that aids in base pairing between sRNAs and their target mRNAs (reviewed in Waters and Storz, 2009). These two regulators have potential advantages over transcriptional regulators in that they provide a faster regulatory speed by modulating

gene expression at a point closer to translation and afford “layered regulation” to tightly control expression (Beisel and Storz, 2010). The sRNAs of each system also have a reduced metabolic cost in that they are not translated.

Recent advances in high-throughput sequencing technologies have allowed global regulons to be elucidated for Hfq (Sittka *et al.*, 2008; Sittka *et al.*, 2009) and CsrA (Chapter 2). Additionally, systematic evolution of ligands by exponential enrichment (SELEX) and Genomic SELEX have uncovered a consensus binding site for CsrA (Dubey *et al.*, 2005) and additional targets for Hfq (Lorenz *et al.*, 2010), respectively, which would have not been easily elucidated by traditional screens. Discovery of preferred binding sites via these techniques also provide data for bioinformatics and computational tools to predict novel targets (Baker *et al.*, 2007). In addition, these studies provide data which can refine predictions and models of complex regulatory networks.

Global regulatory systems frequently employ feedback regulation to modulate the response to a stimulus. Feedback regulation occurs when a regulator influences the expression of its own gene, establishing a closed, autoregulatory loop (Beisel and Storz, 2010). Positive and negative feedback loops possess opposite regulatory properties. The response time of gene expression in system containing a positive feedback circuit is decreased compared to a system lacking a positive feedback loop (Maeda and Sano, 2006). In addition, cell-cell variability (bistability) increases since a small level of activation of a regulatory factor is amplified by further activation of expression (Becskei *et al.*, 2001; Maeda and Sano, 2006). Negative autoregulation can accelerate the regulatory response because an intermediate concentration of the regulatory factor

represses its own expression (Rosenfeld *et al.*, 2002). A negative feedback circuit tends to decrease cell-cell variability and bistability (Becskei and Serrano, 2000) and produces graded responses (Nevozhay *et al.*, 2009). These features contained within networks allow bacteria to robustly detect and amplify specific signals. As mentioned previously, the Csr system is characterized by three defined negative feedback loops, which potentially provide these features to the Csr system and its regulated targets. Indeed, two negative feedback loops within the quorum-sensing LuxO-sRNA signaling network of *V. harveyi* have been demonstrated to contain these characteristics and play a role in mediating the transition between low-cell-density and high-cell-density states (Tu *et al.*, 2010).

The Csr, stringent response, and c-di-GMP systems create an interconnected signaling network, which can be functionally separated into its separate motifs. However, its modularity allows diverse signals to precisely regulate the expression of target genes in an efficient and appropriate manner to benefit the cell as a whole (Chapters 2 and 4). The interconnection between the Csr, stringent response, and c-di-GMP systems defined in this study suggests that overlapping regulons may be a common theme for global networks in *E. coli* and *Salmonella Typhimurium*.

Conclusion

All of the regulatory networks described herein sense specific stimuli and coordinate transcriptional, post-transcriptional, and translational responses that ultimately affect hundreds of gene products and provide global gene reprogramming. The comprehensive regulation and control of the Csr, stringent response and c-di-GMP

signaling networks highlight the importance of providing precise temporal and spatial regulation by incorporating a variety of signals to fine-tune global gene expression. In complex environments, such as nutrient poor soils or within hosts, multiple signals are integrated to allow for rapid adaptation. Determining the interactions between regulators clarifies the characteristics of cellular networks and aids in predicting the way in which a defined biological process may respond to multiple signals.

Understanding the impact and response of global regulatory networks in the model prokaryote *E. coli* provides insights for how systems may be regulated in related species and perhaps even higher organisms. Despite the fact that there appears to be unlimited diversity of networks, their nature is governed by principles that apply to most networks (Barabasi and Oltvai, 2004). The characteristics of regulatory networks in *E. coli* appear to be fundamental for functional organization and may be applicable to systems in eukaryotes. There are a number of signaling motifs that are conserved in both prokaryotes and eukaryotes, including negative and positive feedback loops, crosstalk and modularity (reviewed in Kiel *et al.*, 2010), as well as architectural and mechanistic similarities in signaling proteins (reviewed in Aravind *et al.*, 2003). In addition, ppGpp signaling has been described in plants (van der Biezen *et al.*, 2000; Givens *et al.*, 2004) and appears to function similarly to the *E. coli* stringent response system, as chloroplast RNA polymerase is inhibited by ppGpp in vitro (Takahashi *et al.*, 2004) and ppGpp synthetase activity copurified with the 70S ribosomes of chloroplasts (Kasai *et al.*, 2004). Similar regulatory properties of the stringent response system may apply to the mechanisms by which plants sense and respond to environmental and nutritional stresses. It has also been suggested that the use of ubiquitous second messengers (e.g. ppGpp and

cAMP) in synthetic biology may be useful in engineering novel signal transduction pathways in prokaryotes and eukaryotes (Kiel *et al.*, 2010).

To appropriately coordinate gene expression to allow the most efficient use of energy sources, these global regulatory systems not only perform independent roles but also interact with each other to provide regulatory fine-tuning, which likely confers a competitive advantage for the organism during exposure to the constantly changing conditions of the environment. We are only beginning to understand the impact that CsrA has on controlling bacterial regulation. Continuing to determine the direct targets of CsrA regulation will help us to understand and predict the responses of bacteria to a variety of environments.

References

- Aberg, A., J. Fernandez-Vazquez, J. D. Cabrer-Panes, A. Sanchez and C. Balsalobre. (2009) Similar and divergent effects of ppGpp and DksA deficiencies on transcription in *Escherichia coli*. *J Bacteriol* **191**: 3226-3236.
- Aberg, A., V. Shingler and C. Balsalobre. (2008) Regulation of the *fimB* promoter: a case of differential regulation by ppGpp and DksA in vivo. *Mol Microbiol* **67**: 1223-1241.
- Abranches, J., A. R. Martinez, J. K. Kajfasz, V. Chavez, D. A. Garsin and J. A. Lemos. (2009) The molecular alarmone (p)ppGpp mediates stress responses, vancomycin tolerance, and virulence in *Enterococcus faecalis*. *J Bacteriol* **191**: 2248-2256.
- Altier, C., M. Suyemoto and S. D. Lawhon. (2000) Regulation of *Salmonella enterica* serovar typhimurium invasion genes by *csrA*. *Infect Immun* **68**: 6790-6797.

- Amikam, D. and M. Y. Galperin. (2006) PilZ domain is part of the bacterial c-di-GMP binding protein. *Bioinformatics* **22**: 3-6.
- An, G., J. Justesen, R. J. Watson and J. D. Friesen. (1979) Cloning the *spoT* gene of *Escherichia coli*: identification of the *spoT* gene product. *J Bacteriol* **137**: 1100-1110.
- Andrade, M. O., M. C. Alegria, C. R. Guzzo, C. Docena, M. C. Rosa, C. H. Ramos and C. S. Farah. (2006) The HD-GYP domain of RpfG mediates a direct linkage between the Rpf quorum-sensing pathway and a subset of diguanylate cyclase proteins in the phytopathogen *Xanthomonas axonopodis* pv *citri*. *Mol Microbiol* **62**: 537-551.
- Aravind, L., V. Anantharaman and L. M. Iyer. (2003) Evolutionary connections between bacterial and eukaryotic signaling systems: a genomic perspective. *Curr Opin Microbiol* **6**: 490-497.
- Aravind, L. and E. V. Koonin. (1998) The HD domain defines a new superfamily of metal-dependent phosphohydrolases. *Trends Biochem Sci* **23**: 469-472.
- Aravind, L. and C. P. Ponting. (1999) The cytoplasmic helical linker domain of receptor histidine kinase and methyl-accepting proteins is common to many prokaryotic signalling proteins. *FEMS Microbiol Lett* **176**: 111-116.
- Artsimovitch, I., V. Patlan, S. Sekine, M. N. Vassylyeva, T. Hosaka, K. Ochi, S. Yokoyama and D. G. Vassylyev. (2004) Structural basis for transcription regulation by alarmone ppGpp. *Cell* **117**: 299-310.

- Ausmees, N., R. Mayer, H. Weinhouse, G. Volman, D. Amikam, M. Benziman and M. Lindberg. (2001) Genetic data indicate that proteins containing the GGDEF domain possess diguanylate cyclase activity. *FEMS Microbiol Lett* **204**: 163-167.
- Avarbock, A., D. Avarbock, J. S. Teh, M. Buckstein, Z. M. Wang and H. Rubin. (2005) Functional regulation of the opposing (p)ppGpp synthetase/hydrolase activities of RelMtb from *Mycobacterium tuberculosis*. *Biochemistry* **44**: 9913-9923.
- Avarbock, D., A. Avarbock and H. Rubin. (2000) Differential regulation of opposing RelMtb activities by the aminoacylation state of a tRNA.ribosome.mRNA.RelMtb complex. *Biochemistry* **39**: 11640-11648.
- Baker, C. S., I. Berezin, T. Romeo and P. Babitzke. (2010) CsrA activates *flhDC* expression by inhibiting RNase E cleavage of the *flhDC* leader transcript in *Escherichia coli*. *Proc Natl Acad Sci U S A* (Submitted).
- Baker, C. S., L. A. Eory, H. Yakhnin, J. Mercante, T. Romeo and P. Babitzke. (2007) CsrA inhibits translation initiation of *Escherichia coli hfq* by binding to a single site overlapping the Shine-Dalgarno sequence. *J Bacteriol* **189**: 5472-5481.
- Baker, C. S., I. Morozov, K. Suzuki, T. Romeo and P. Babitzke. (2002) CsrA regulates glycogen biosynthesis by preventing translation of *glgC* in *Escherichia coli*. *Mol Microbiol* **44**: 1599-1610.
- Barabasi, A. L. and Z. N. Oltvai. (2004) Network biology: understanding the cell's functional organization. *Nat Rev Genet* **5**: 101-113.
- Barends, T. R., E. Hartmann, J. J. Griese, T. Beitlich, N. V. Kirienko, D. A. Ryjenkov, J. Reinstein, R. L. Shoeman, M. Gomelsky and I. Schlichting. (2009) Structure and

mechanism of a bacterial light-regulated cyclic nucleotide phosphodiesterase. *Nature* **459**: 1015-1018.

Barker, M. M., T. Gaal and R. L. Gourse. (2001a) Mechanism of regulation of transcription initiation by ppGpp. II. Models for positive control based on properties of RNAP mutants and competition for RNAP. *J Mol Biol* **305**: 689-702.

Barker, M. M., T. Gaal, C. A. Josaitis and R. L. Gourse. (2001b) Mechanism of regulation of transcription initiation by ppGpp. I. Effects of ppGpp on transcription initiation in vivo and in vitro. *J Mol Biol* **305**: 673-688.

Bartlett, M. S., T. Gaal, W. Ross and R. L. Gourse. (1998) RNA polymerase mutants that destabilize RNA polymerase-promoter complexes alter NTP-sensing by *rrn* P1 promoters. *J Mol Biol* **279**: 331-345.

Battesti, A. and E. Bouveret. (2006) Acyl carrier protein/SpoT interaction, the switch linking SpoT-dependent stress response to fatty acid metabolism. *Mol Microbiol* **62**: 1048-1063.

Battesti, A. and E. Bouveret. (2009) Bacteria possessing two RelA/SpoT-like proteins have evolved a specific stringent response involving the acyl carrier protein-SpoT interaction. *J Bacteriol* **191**: 616-624.

Becskei, A., B. Seraphin and L. Serrano. (2001) Positive feedback in eukaryotic gene networks: cell differentiation by graded to binary response conversion. *EMBO J* **20**: 2528-2535.

Becskei, A. and L. Serrano. (2000) Engineering stability in gene networks by autoregulation. *Nature* **405**: 590-593.

- Beisel, C. L. and G. Storz. (2010) Base pairing small RNAs and their roles in global regulatory networks. *FEMS Microbiol Rev.*
- Benach, J., S. S. Swaminathan, R. Tamayo, S. K. Handelman, E. Folta-Stogniew, J. E. Ramos, F. Forouhar, H. Neely, J. Seetharaman, A. Camilli and J. F. Hunt. (2007) The structural basis of cyclic diguanylate signal transduction by PilZ domains. *EMBO J* **26**: 5153-5166.
- Bernardo, L. M., L. U. Johansson, D. Solera, E. Skarfstad and V. Shingler. (2006) The guanosine tetraphosphate (ppGpp) alarmone, DksA and promoter affinity for RNA polymerase in regulation of sigma-dependent transcription. *Mol Microbiol* **60**: 749-764.
- Beyhan, S., L. S. Odell and F. H. Yildiz. (2008) Identification and characterization of cyclic diguanylate signaling systems controlling rugosity in *Vibrio cholerae*. *J Bacteriol* **190**: 7392-7405.
- Blankschien, M. D., J. H. Lee, E. D. Grace, C. W. Lennon, J. A. Halliday, W. Ross, R. L. Gourse and C. Herman. (2009) Super DksAs: substitutions in DksA enhancing its effects on transcription initiation. *EMBO J* **28**: 1720-1731.
- Blumer, C., S. Heeb, G. Pessi and D. Haas. (1999) Global GacA-steered control of cyanide and exoprotease production in *Pseudomonas fluorescens* involves specific ribosome binding sites. *Proc Natl Acad Sci U S A* **96**: 14073-14078.
- Bobrov, A. G., O. Kirillina, S. Forman, D. Mack and R. D. Perry. (2008) Insights into *Yersinia pestis* biofilm development: topology and co-interaction of Hms inner membrane proteins involved in exopolysaccharide production. *Environ Microbiol* **10**: 1419-1432.

- Bobrov, A. G., O. Kirillina and R. D. Perry. (2005) The phosphodiesterase activity of the HmsP EAL domain is required for negative regulation of biofilm formation in *Yersinia pestis*. *Fems Microbiology Letters* **247**: 123-130.
- Boehm, A., M. Kaiser, H. Li, C. Spangler, C. A. Kasper, M. Ackermann, V. Kaefer, V. Sourjik, V. Roth and U. Jenal. (2010) Second messenger-mediated adjustment of bacterial swimming velocity. *Cell* **141**: 107-116.
- Boehm, A., S. Steiner, F. Zaehring, A. Casanova, F. Hamburger, D. Ritz, W. Keck, M. Ackermann, T. Schirmer and U. Jenal. (2009) Second messenger signalling governs *Escherichia coli* biofilm induction upon ribosomal stress. *Mol Microbiol* **72**: 1500-1516.
- Bougdour, A. and S. Gottesman. (2007) ppGpp regulation of RpoS degradation via anti-adaptor protein IraP. *Proc Natl Acad Sci U S A* **104**: 12896-12901.
- Branny, P., J. P. Pearson, E. C. Pesci, T. Kohler, B. H. Iglewski and C. Van Delden. (2001) Inhibition of quorum sensing by a *Pseudomonas aeruginosa* *dksA* homologue. *J Bacteriol* **183**: 1531-1539.
- Bremer, H. and P. P. Dennis. (1996) Modulation of chemical composition and other parameters of the cell by growth rate. In: *Escherichia coli* and *Salmonella*: Cellular and Molecular Biology. F. C. Neidhardt (ed). Washington, D.C.: ASM Press, pp. 1553-1569.
- Brencic, A. and S. Lory. (2009) Determination of the regulon and identification of novel mRNA targets of *Pseudomonas aeruginosa* RsmA. *Mol Microbiol* **72**: 612-632.
- Brown, L., D. Gentry, T. Elliott and M. Cashel. (2002) DksA affects ppGpp induction of RpoS at a translational level. *J Bacteriol* **184**: 4455-4465.

- Buglino, J., V. Shen, P. Hakimian and C. D. Lima. (2002) Structural and biochemical analysis of the Obg GTP binding protein. *Structure* **10**: 1581-1592.
- Burrowes, E., A. Abbas, A. O'Neill, C. Adams and F. O'Gara. (2005) Characterisation of the regulatory RNA RsmB from *Pseudomonas aeruginosa* PAO1. *Res Microbiol* **156**: 7-16.
- Burrowes, E., C. Baysse, C. Adams and F. O'Gara. (2006) Influence of the regulatory protein RsmA on cellular functions in *Pseudomonas aeruginosa* PAO1, as revealed by transcriptome analysis. *Microbiology* **152**: 405-418.
- Cashel, M. and J. Gallant. (1969) Two compounds implicated in the function of the *RC* gene of *Escherichia coli*. *Nature* **221**: 838-841.
- Cashel, M., D. Gentry, V. J. Hernandez and D. Vinella. (1996) The stringent response. In: *Escherichia coli and Salmonella: Cellular and Molecular Biology*. F. C. Neidhardt, *et al.* (ed). Washington, D.C.: ASM Press, pp. 1458-1496.
- Chan, C., R. Paul, D. Samoray, N. C. Amiot, B. Giese, U. Jenal and T. Schirmer. (2004) Structural basis of activity and allosteric control of diguanylate cyclase. *Proc Natl Acad Sci U S A* **101**: 17084-17089.
- Chancey, S. T., D. W. Wood and L. S. Pierson, 3rd. (1999) Two-component transcriptional regulation of N-acyl-homoserine lactone production in *Pseudomonas aureofaciens*. *Appl Environ Microbiol* **65**: 2294-2299.
- Chang, A. L., J. R. Tuckerman, G. Gonzalez, R. Mayer, H. Weinhouse, G. Volman, D. Amikam, M. Benziman and M. A. Gilles-Gonzalez. (2001) Phosphodiesterase A1, a regulator of cellulose synthesis in *Acetobacter xylinum*, is a heme-based sensor. *Biochemistry* **40**: 3420-3426.

- Chatterjee, A., Y. Cui, P. Chakrabarty and A. K. Chatterjee. (2010) Regulation of Motility in *Erwinia carotovora* subsp. *carotovora*: Quorum-Sensing Signal Controls FlhDC, the Global Regulator of Flagellar and Exoprotein Genes, by Modulating the Production of RsmA, an RNA-Binding Protein. *Mol Plant Microbe Interact* **23**: 1316-1323.
- Chatterjee, A., Y. Cui and A. K. Chatterjee. (2009) RsmC of *Erwinia carotovora* subsp. *carotovora* negatively controls motility, extracellular protein production, and virulence by binding FlhD and modulating transcriptional activity of the master regulator, FlhDC. *J Bacteriol* **191**: 4582-4593.
- Chatterjee, A., Y. Cui, H. Hasegawa, N. Leigh, V. Dixit and A. K. Chatterjee. (2005) Comparative analysis of two classes of quorum-sensing signaling systems that control production of extracellular proteins and secondary metabolites in *Erwinia carotovora* subspecies. *J Bacteriol* **187**: 8026-8038.
- Chatterjee, A., Y. Cui, Y. Liu, C. K. Dumenyo and A. K. Chatterjee. (1995) Inactivation of *rsmA* leads to overproduction of extracellular pectinases, cellulases, and proteases in *Erwinia carotovora* subsp. *carotovora* in the absence of the starvation/cell density-sensing signal, N-(3-oxohexanoyl)-L-homoserine lactone. *Appl Environ Microbiol* **61**: 1959-1967.
- Chavez, R. G., A. F. Alvarez, T. Romeo and D. Georgellis. (2010) The physiological stimulus for the BarA sensor kinase. *J Bacteriol* **192**: 2009-2012.
- Chin, K. H., Y. C. Lee, Z. L. Tu, C. H. Chen, Y. H. Tseng, J. M. Yang, R. P. Ryan, Y. McCarthy, J. M. Dow, A. H. Wang and S. H. Chou. (2010) The cAMP receptor-

- like protein CLP is a novel c-di-GMP receptor linking cell-cell signaling to virulence gene expression in *Xanthomonas campestris*. *J Mol Biol* **396**: 646-662.
- Christen, B., M. Christen, R. Paul, F. Schmid, M. Folcher, P. Jenoe, M. Meuwly and U. Jenal. (2006) Allosteric control of cyclic di-GMP signaling. *J Biol Chem* **281**: 32015-32024.
- Christen, M., B. Christen, M. G. Allan, M. Folcher, P. Jenoe, S. Grzesiek and U. Jenal. (2007) DgrA is a member of a new family of cyclic diguanosine monophosphate receptors and controls flagellar motor function in *Caulobacter crescentus*. *Proc Natl Acad Sci U S A* **104**: 4112-4117.
- Christen, M., B. Christen, M. Folcher, A. Schauerte and U. Jenal. (2005) Identification and characterization of a cyclic di-GMP-specific phosphodiesterase and its allosteric control by GTP. *J Biol Chem* **280**: 30829-30837.
- Cochran, J. W. and R. W. Byrne. (1974) Isolation and properties of a ribosome-bound factor required for ppGpp and ppGpp synthesis in *Escherichia coli*. *J Biol Chem* **249**: 353-360.
- Costanzo, A., H. Nicoloff, S. E. Barchinger, A. B. Banta, R. L. Gourse and S. E. Ades. (2008) ppGpp and DksA likely regulate the activity of the extracytoplasmic stress factor sigmaE in *Escherichia coli* by both direct and indirect mechanisms. *Mol Microbiol* **67**: 619-632.
- Costerton, J. W. (1995) Overview of microbial biofilms. *J Ind Microbiol* **15**: 137-140.
- Cotter, P. A. and J. F. Miller. (1997) A mutation in the *Bordetella bronchiseptica* *bvgS* gene results in reduced virulence and increased resistance to starvation, and identifies a new class of Bvg-regulated antigens. *Mol Microbiol* **24**: 671-685.

- Cotter, P. A. and S. Stibitz. (2007) c-di-GMP-mediated regulation of virulence and biofilm formation. *Curr Opin Microbiol* **10**: 17-23.
- Cui, Y., A. Chatterjee and A. K. Chatterjee. (2001) Effects of the two-component system comprising GacA and GacS of *Erwinia carotovora* subsp. *carotovora* on the production of global regulatory *rsmB* RNA, extracellular enzymes, and harpinEcc. *Mol Plant Microbe Interact* **14**: 516-526.
- Cui, Y., A. Chatterjee, H. Hasegawa and A. K. Chatterjee. (2006) *Erwinia carotovora* subspecies produce duplicate variants of ExpR, LuxR homologs that activate *rsmA* transcription but differ in their interactions with N-acylhomoserine lactone signals. *J Bacteriol* **188**: 4715-4726.
- Cui, Y., A. Chatterjee, H. Hasegawa, V. Dixit, N. Leigh and A. K. Chatterjee. (2005) ExpR, a LuxR homolog of *Erwinia carotovora* subsp. *carotovora*, activates transcription of *rsmA*, which specifies a global regulatory RNA-binding protein. *J Bacteriol* **187**: 4792-4803.
- Cui, Y., A. Chatterjee, Y. Liu, C. K. Dumenyo and A. K. Chatterjee. (1995) Identification of a global repressor gene, *rsmA*, of *Erwinia carotovora* subsp. *carotovora* that controls extracellular enzymes, N-(3-oxohexanoyl)-L-homoserine lactone, and pathogenicity in soft-rotting *Erwinia* spp. *J Bacteriol* **177**: 5108-5115.
- Cui, Y., A. Chatterjee, H. Yang and A. K. Chatterjee. (2008) Regulatory network controlling extracellular proteins in *Erwinia carotovora* subsp. *carotovora*: FlhDC, the master regulator of flagellar genes, activates *rsmB* regulatory RNA production by affecting *gacA* and *hexA* (*lrhA*) expression. *J Bacteriol* **190**: 4610-4623.

- Cui, Y., A. Mukherjee, C. K. Dumenyo, Y. Liu and A. K. Chatterjee. (1999) *rsmC* of the soft-rotting bacterium *Erwinia carotovora* subsp. *carotovora* negatively controls extracellular enzyme and harpin(Ecc) production and virulence by modulating levels of regulatory RNA (*rsmB*) and RNA-binding protein (RsmA). *J Bacteriol* **181**: 6042-6052.
- Dalebroux, Z. D., R. L. Edwards and M. S. Swanson. (2009) SpoT governs *Legionella pneumophila* differentiation in host macrophages. *Mol Microbiol* **71**: 640-658.
- Dalebroux, Z. D., S. L. Svensson, E. C. Gaynor and M. S. Swanson, (2010) ppGpp conjures bacterial virulence. *Microbiol Mol Biol Rev* **74**: 171-199.
- Das, B. and R. K. Bhadra. (2008) Molecular characterization of *Vibrio cholerae* DeltareA DeltaspoT double mutants. *Arch Microbiol* **189**: 227-238.
- Das, B., R. R. Pal, S. Bag and R. K. Bhadra. (2009) Stringent response in *Vibrio cholerae*: genetic analysis of *spoT* gene function and identification of a novel (p)ppGpp synthetase gene. *Mol Microbiol* **72**: 380-398.
- Datta, K., J. M. Skidmore, K. Pu and J. R. Maddock. (2004) The *Caulobacter crescentus* GTPase CgtAC is required for progression through the cell cycle and for maintaining 50S ribosomal subunit levels. *Mol Microbiol* **54**: 1379-1392.
- De, N., M. V. Navarro, R. V. Raghavan and H. Sondermann. (2009) Determinants for the activation and autoinhibition of the diguanylate cyclase response regulator WspR. *J Mol Biol* **393**: 619-633.
- De, N., M. Pirruccello, P. V. Krasteva, N. Bae, R. V. Raghavan and H. Sondermann. (2008) Phosphorylation-independent regulation of the diguanylate cyclase WspR. *PLoS Biol* **6**: e67.

- Dubey, A. K., C. S. Baker, T. Romeo and P. Babitzke. (2005) RNA sequence and secondary structure participate in high-affinity CsrA-RNA interaction. *RNA* **11**: 1579-1587.
- Dubey, A. K., C. S. Baker, K. Suzuki, A. D. Jones, P. Pandit, T. Romeo and P. Babitzke. (2003) CsrA regulates translation of the *Escherichia coli* carbon starvation gene, *cstA*, by blocking ribosome access to the *cstA* transcript. *J Bacteriol* **185**: 4450-4460.
- Duerig, A., S. Abel, M. Folcher, M. Nicollier, T. Schwede, N. Amiot, B. Giese and U. Jenal. (2009) Second messenger-mediated spatiotemporal control of protein degradation regulates bacterial cell cycle progression. *Genes Dev* **23**: 93-104.
- Edwards, R. L., M. Jules, T. Sahr, C. Buchrieser and M. S. Swanson. (2010) The *Legionella pneumophila* LetA/LetS two-component system exhibits rheostat-like behavior. *Infect Immun* **78**: 2571-2583.
- Fang, X. and M. Gomelsky. (2010) A post-translational, c-di-GMP-dependent mechanism regulating flagellar motility. *Mol Microbiol* **76**: 1295-1305.
- Ferreira, R. B., L. C. Antunes, E. P. Greenberg and L. L. McCarter. (2008) *Vibrio parahaemolyticus* ScrC modulates cyclic dimeric GMP regulation of gene expression relevant to growth on surfaces. *J Bacteriol* **190**: 851-860.
- Ferullo, D. J. and S. T. Lovett. (2008) The stringent response and cell cycle arrest in *Escherichia coli*. *PLoS Genet* **4**: e1000300.
- Fields, J. A. and S. A. Thompson. (2008) *Campylobacter jejuni* CsrA mediates oxidative stress responses, biofilm formation, and host cell invasion. *J Bacteriol* **190**: 3411-3416.

- Fineran, P. C., N. R. Williamson, K. S. Lilley and G. P. Salmond. (2007) Virulence and prodigiosin antibiotic biosynthesis in *Serratia* are regulated pleiotropically by the GGDEF/EAL domain protein, PigX. *J Bacteriol* **189**: 7653-7662.
- Fong, J. C. and F. H. Yildiz. (2008) Interplay between cyclic AMP-cyclic AMP receptor protein and cyclic di-GMP signaling in *Vibrio cholerae* biofilm formation. *J Bacteriol* **190**: 6646-6659.
- Fortune, D. R., M. Suyemoto and C. Altier. (2006) Identification of CsrC and characterization of its role in epithelial cell invasion in *Salmonella enterica* serovar Typhimurium. *Infect Immun* **74**: 331-339.
- Foti, J. J., J. Schienda, V. A. Suter, Jr. and S. T. Lovett. (2005) A bacterial G protein-mediated response to replication arrest. *Mol Cell* **17**: 549-560.
- Friesen, J. D., N. P. Fiil, J. M. Parker and W. A. Haseltine. (1974) A new relaxed mutant of *Escherichia coli* with an altered 50S ribosomal subunit. *Proc Natl Acad Sci U S A* **71**: 3465-3469.
- Gaal, T., M. S. Bartlett, W. Ross, C. L. Turnbough, Jr. and R. L. Gourse. (1997) Transcription regulation by initiating NTP concentration: rRNA synthesis in bacteria. *Science* **278**: 2092-2097.
- Gallant, J., J. Irr and M. Cashel. (1971) The mechanism of amino acid control of guanylate and adenylate biosynthesis. *J Biol Chem* **246**: 5812-5816.
- Galperin, M. Y., D. A. Natale, L. Aravind and E. V. Koonin. (1999) A specialized version of the HD hydrolase domain implicated in signal transduction. *J Mol Microbiol Biotechnol* **1**: 303-305.

- Galperin, M. Y., A. N. Nikolskaya and E. V. Koonin. (2001) Novel domains of the prokaryotic two-component signal transduction systems. *Fems Microbiology Letters* **203**: 11-21.
- Gama-Castro, S., V. Jimenez-Jacinto, M. Peralta-Gil, A. Santos-Zavaleta, M. I. Penaloza-Spinola, B. Contreras-Moreira, J. Segura-Salazar, L. Muniz-Rascado, I. Martinez-Flores, H. Salgado, C. Bonavides-Martinez, C. Abreu-Goodger, C. Rodriguez-Penagos, J. Miranda-Rios, E. Morett, E. Merino, A. M. Huerta, L. Trevino-Quintanilla and J. Collado-Vides. (2008) RegulonDB (version 6.0): gene regulation model of *Escherichia coli* K-12 beyond transcription, active (experimental) annotated promoters and Textpresso navigation. *Nucleic Acids Res* **36**: D120-124.
- Gentry, D., H. Xiao, R. Burgess and M. Cashel. (1991) The omega subunit of *Escherichia coli* K-12 RNA polymerase is not required for stringent RNA control in vivo. *J Bacteriol* **173**: 3901-3903.
- Gentry, D. R. and R. R. Burgess. (1989) *rpoZ*, encoding the omega subunit of *Escherichia coli* RNA polymerase, is in the same operon as *spoT*. *J Bacteriol* **171**: 1271-1277.
- Gentry, D. R. and R. R. Burgess. (1993) Cross-linking of *Escherichia coli* RNA polymerase subunits: identification of beta' as the binding site of omega. *Biochemistry* **32**: 11224-11227.
- Gentry, D. R. and M. Cashel. (1996) Mutational analysis of the *Escherichia coli spoT* gene identifies distinct but overlapping regions involved in ppGpp synthesis and degradation. *Mol Microbiol* **19**: 1373-1384.

- Gentry, D. R., V. J. Hernandez, L. H. Nguyen, D. B. Jensen and M. Cashel. (1993) Synthesis of the stationary-phase sigma factor sigma s is positively regulated by ppGpp. *J Bacteriol* **175**: 7982-7989.
- Ghosh, P., A. Ishihama and D. Chatterji. (2001) *Escherichia coli* RNA polymerase subunit omega and its N-terminal domain bind full-length beta' to facilitate incorporation into the alpha2beta subassembly. *Eur J Biochem* **268**: 4621-4627.
- Givens, R. M., M. H. Lin, D. J. Taylor, U. Mechold, J. O. Berry and V. J. Hernandez. (2004) Inducible expression, enzymatic activity, and origin of higher plant homologues of bacterial RelA/SpoT stress proteins in *Nicotiana tabacum*. *J Biol Chem* **279**: 7495-7504.
- Goller, C., X. Wang, Y. Itoh and T. Romeo. (2006) The cation-responsive protein NhaR of *Escherichia coli* activates *pgaABCD* transcription, required for production of the biofilm adhesin poly-beta-1,6-N-acetyl-D-glucosamine. *J Bacteriol* **188**: 8022-8032.
- Gong, L., K. Takayama and S. Kjelleberg. (2002) Role of spoT-dependent ppGpp accumulation in the survival of light-exposed starved bacteria. *Microbiology* **148**: 559-570.
- Goodman, A. L., B. Kulasekara, A. Rietsch, D. Boyd, R. S. Smith and S. Lory. (2004) A signaling network reciprocally regulates genes associated with acute infection and chronic persistence in *Pseudomonas aeruginosa*. *Dev Cell* **7**: 745-754.
- Goodman, A. L., M. Merighi, M. Hyodo, I. Ventre, A. Filloux and S. Lory. (2009) Direct interaction between sensor kinase proteins mediates acute and chronic disease phenotypes in a bacterial pathogen. *Genes Dev* **23**: 249-259.

- Gropp, M., Y. Strausz, M. Gross and G. Glaser. (2001) Regulation of *Escherichia coli* RelA requires oligomerization of the C-terminal domain. *J Bacteriol* **183**: 570-579.
- Gudapaty, S., K. Suzuki, X. Wang, P. Babitzke and T. Romeo. (2001) Regulatory interactions of Csr components: the RNA binding protein CsrA activates *csrB* transcription in *Escherichia coli*. *J Bacteriol* **183**: 6017-6027.
- Guo, Y. and D. A. Rowe-Magnus. (2010) Identification of a c-di-GMP-regulated polysaccharide locus governing stress resistance and biofilm and rugose colony formation in *Vibrio vulnificus*. *Infect Immun* **78**: 1390-1402.
- Gutierrez, P., Y. Li, M. J. Osborne, E. Pomerantseva, Q. Liu and K. Gehring. (2005) Solution structure of the carbon storage regulator protein CsrA from *Escherichia coli*. *J Bacteriol* **187**: 3496-3501.
- Guvener, Z. T. and C. S. Harwood. (2007) Subcellular location characteristics of the *Pseudomonas aeruginosa* GGDEF protein, WspR, indicate that it produces cyclic-di-GMP in response to growth on surfaces. *Mol Microbiol* **66**: 1459-1473.
- Haas, D., C. Keel and C. Reimmann. (2002) Signal transduction in plant-beneficial rhizobacteria with biocontrol properties. *Antonie Van Leeuwenhoek* **81**: 385-395.
- Hammer, B. K. and B. L. Bassler. (2009) Distinct sensory pathways in *Vibrio cholerae* El Tor and classical biotypes modulate cyclic dimeric GMP levels to control biofilm formation. *J Bacteriol* **191**: 169-177.
- Hammer, B. K., E. S. Tateda and M. S. Swanson. (2002) A two-component regulator induces the transmission phenotype of stationary-phase *Legionella pneumophila*. *Mol Microbiol* **44**: 107-118.

- Handke, L. D., R. P. Shivers and A. L. Sonenshein. (2008) Interaction of *Bacillus subtilis* CodY with GTP. *J Bacteriol* **190**: 798-806.
- Hasegawa, K., S. Masuda and T. A. Ono. (2006) Light induced structural changes of a full-length protein and its BLUF domain in YcgF(Blrp), a blue-light sensing protein that uses FAD (BLUF). *Biochemistry* **45**: 3785-3793.
- Haseltine, W. A. and R. Block. (1973) Synthesis of guanosine tetra- and pentaphosphate requires the presence of a codon-specific, uncharged transfer ribonucleic acid in the acceptor site of ribosomes. *Proc Natl Acad Sci U S A* **70**: 1564-1568.
- Haugen, S. P., M. B. Berkmen, W. Ross, T. Gaal, C. Ward and R. L. Gourse. (2006) rRNA promoter regulation by nonoptimal binding of sigma region 1.2: an additional recognition element for RNA polymerase. *Cell* **125**: 1069-1082.
- Hecht, G. B. and A. Newton. (1995) Identification of a novel response regulator required for the swarmer-to-stalked-cell transition in *Caulobacter crescentus*. *J Bacteriol* **177**: 6223-6229.
- Heeb, S., C. Blumer and D. Haas. (2002) Regulatory RNA as mediator in GacA/RsmA-dependent global control of exoproduct formation in *Pseudomonas fluorescens* CHA0. *J Bacteriol* **184**: 1046-1056.
- Heeb, S., S. A. Kuehne, M. Bycroft, S. Crivii, M. D. Allen, D. Haas, M. Camara and P. Williams. (2006) Functional analysis of the post-transcriptional regulator RsmA reveals a novel RNA-binding site. *J Mol Biol* **355**: 1026-1036.
- Heeb, S., C. Valverde, C. Gigot-Bonnefoy and D. Haas. (2005) Role of the stress sigma factor RpoS in GacA/RsmA-controlled secondary metabolism and resistance to

- oxidative stress in *Pseudomonas fluorescens* CHA0. *FEMS Microbiol Lett* **243**: 251-258.
- Heinemeyer, E. A. and D. Richter. (1977) In vitro degradation of guanosine tetraphosphate (ppGpp) by an enzyme associated with the ribosomal fraction from *Escherichia coli*. *FEBS Lett* **84**: 357-361.
- Hengge, R. (2009) Principles of c-di-GMP signalling in bacteria. *Nat Rev Microbiol* **7**: 263-273.
- Hernandez, V. J. and H. Bremer. (1991) *Escherichia coli* ppGpp synthetase II activity requires *spoT*. *J Biol Chem* **266**: 5991-5999.
- Hernandez, V. J. and M. Cashel. (1995) Changes in conserved region 3 of *Escherichia coli* sigma 70 mediate ppGpp-dependent functions in vivo. *J Mol Biol* **252**: 536-549.
- Heurlier, K., F. Williams, S. Heeb, C. Dormond, G. Pessi, D. Singer, M. Camara, P. Williams and D. Haas. (2004) Positive control of swarming, rhamnolipid synthesis, and lipase production by the posttranscriptional RsmA/RsmZ system in *Pseudomonas aeruginosa* PAO1. *J Bacteriol* **186**: 2936-2945.
- Hickman, J. W. and C. S. Harwood. (2008) Identification of FleQ from *Pseudomonas aeruginosa* as a c-di-GMP-responsive transcription factor. *Mol Microbiol* **69**: 376-389.
- Hirsch, M. and T. Elliott. (2002) Role of ppGpp in rpoS stationary-phase regulation in *Escherichia coli*. *J Bacteriol* **184**: 5077-5087.
- Hogg, T., U. Mechold, H. Malke, M. Cashel and R. Hilgenfeld. (2004) Conformational antagonism between opposing active sites in a bifunctional RelA/SpoT homolog

modulates (p)ppGpp metabolism during the stringent response [corrected]. *Cell* **117**: 57-68.

Holland, L. M., S. T. O'Donnell, D. A. Ryjenkov, L. Gomelsky, S. R. Slater, P. D. Fey, M. Gomelsky and J. P. O'Gara. (2008) A staphylococcal GGDEF domain protein regulates biofilm formation independently of cyclic dimeric GMP. *J Bacteriol* **190**: 5178-5189.

Hovel-Miner, G., S. Pampou, S. P. Faucher, M. Clarke, I. Morozova, P. Morozov, J. J. Russo, H. A. Shuman and S. Kalachikov. (2009) SigmaS controls multiple pathways associated with intracellular multiplication of *Legionella pneumophila*. *J Bacteriol* **191**: 2461-2473.

Hrabak, E. M. and D. K. Willis. (1992) The *lemA* gene required for pathogenicity of *Pseudomonas syringae* pv. *syringae* on bean is a member of a family of two-component regulators. *J Bacteriol* **174**: 3011-3020.

Hsu, L. M., N. V. Vo and M. J. Chamberlin. (1995) *Escherichia coli* transcript cleavage factors GreA and GreB stimulate promoter escape and gene expression in vivo and in vitro. *Proc Natl Acad Sci U S A* **92**: 11588-11592.

Huitema, E., S. Pritchard, D. Matteson, S. K. Radhakrishnan and P. H. Viollier. (2006) Bacterial birth scar proteins mark future flagellum assembly site. *Cell* **124**: 1025-1037.

Humair, B., B. Wackwitz and D. Haas. (2010) GacA-controlled activation of promoters for small RNA genes in *Pseudomonas fluorescens*. *Appl Environ Microbiol* **76**: 1497-1506.

- Igarashi, K., N. Fujita and A. Ishihama. (1989) Promoter selectivity of *Escherichia coli* RNA polymerase: omega factor is responsible for the ppGpp sensitivity. *Nucleic Acids Res* **17**: 8755-8765.
- Inaoka, T. and K. Ochi. (2002) RelA protein is involved in induction of genetic competence in certain *Bacillus subtilis* strains by moderating the level of intracellular GTP. *J Bacteriol* **184**: 3923-3930.
- Ishii, Y., H. Yamada, T. Yamashino, K. Ohashi, E. Katoh, H. Shindo, T. Yamazaki and T. Mizuno. (2000) Deletion of the *yhhP* gene results in filamentous cell morphology in *Escherichia coli*. *Biosci Biotechnol Biochem* **64**: 799-807.
- Itoh, Y., J. D. Rice, C. Goller, A. Pannuri, J. Taylor, J. Meisner, T. J. Beveridge, J. F. Preston, 3rd and T. Romeo. (2008) Roles of *pgaABCD* genes in synthesis, modification, and export of the *Escherichia coli* biofilm adhesin poly-beta-1,6-N-acetyl-D-glucosamine. *J Bacteriol* **190**: 3670-3680.
- Jang, J., K. T. Jung, C. K. Yoo and G. E. Rhie. (2010) Regulation of hemagglutinin/protease expression by the VarS/VarA-CsrA/B/C/D system in *Vibrio cholerae*. *Microb Pathog* **48**: 245-250.
- Jenal, U. and J. Malone. (2006) Mechanisms of cyclic-di-GMP signaling in bacteria. *Annu Rev Genet* **40**: 385-407.
- Jiang, M., S. M. Sullivan, P. K. Wout and J. R. Maddock. (2007) G-protein control of the ribosome-associated stress response protein SpoT. *J Bacteriol* **189**: 6140-6147.
- Jishage, M., K. Kvint, V. Shingler and T. Nystrom. (2002) Regulation of sigma factor competition by the alarmone ppGpp. *Genes Dev* **16**: 1260-1270.

- Jonas, K. and O. Melefors. (2009) The *Escherichia coli* CsrB and CsrC small RNAs are strongly induced during growth in nutrient-poor medium. *FEMS Microbiol Lett* **297**: 80-86.
- Jonas, K., O. Melefors and U. Romling. (2009) Regulation of c-di-GMP metabolism in biofilms. *Future Microbiol* **4**: 341-358.
- Jonas, K., H. Tomenius, U. Romling, D. Georgellis and O. Melefors. (2006) Identification of YhdA as a regulator of the *Escherichia coli* carbon storage regulation system. *FEMS Microbiol Lett* **264**: 232-237.
- Josaitis, C. A., T. Gaal and R. L. Gourse. (1995) Stringent control and growth-rate-dependent control have nonidentical promoter sequence requirements. *Proc Natl Acad Sci U S A* **92**: 1117-1121.
- Kang, P. J. and E. A. Craig. (1990) Identification and characterization of a new *Escherichia coli* gene that is a dosage-dependent suppressor of a *dnaK* deletion mutation. *J Bacteriol* **172**: 2055-2064.
- Kang, Y., V. V. Lunin, T. Skarina, A. Savchenko, M. J. Schurr and T. T. Hoang. (2009) The long-chain fatty acid sensor, PsrA, modulates the expression of *rpoS* and the type III secretion *exsCEBA* operon in *Pseudomonas aeruginosa*. *Mol Microbiol* **73**: 120-136.
- Kasai, K., T. Kanno, Y. Endo, K. Wakasa and Y. Tozawa. (2004) Guanosine tetra- and pentaphosphate synthase activity in chloroplasts of a higher plant: association with 70S ribosomes and inhibition by tetracycline. *Nucleic Acids Res* **32**: 5732-5741.

- Kasai, K., T. Nishizawa, K. Takahashi, T. Hosaka, H. Aoki and K. Ochi. (2006) Physiological analysis of the stringent response elicited in an extreme thermophilic bacterium, *Thermus thermophilus*. *J Bacteriol* **188**: 7111-7122.
- Kay, E., C. Dubuis and D. Haas. (2005) Three small RNAs jointly ensure secondary metabolism and biocontrol in *Pseudomonas fluorescens* CHA0. *Proc Natl Acad Sci U S A* **102**: 17136-17141.
- Kay, E., B. Humair, V. Denervaud, K. Riedel, S. Spahr, L. Eberl, C. Valverde and D. Haas. (2006) Two GacA-dependent small RNAs modulate the quorum-sensing response in *Pseudomonas aeruginosa*. *J Bacteriol* **188**: 6026-6033.
- Kazmierczak, B. I., M. B. Lebron and T. S. Murray. (2006) Analysis of FimX, a phosphodiesterase that governs twitching motility in *Pseudomonas aeruginosa*. *Mol Microbiol* **60**: 1026-1043.
- Keasling, J. D., L. Bertsch and A. Kornberg. (1993) Guanosine pentaphosphate phosphohydrolase of *Escherichia coli* is a long-chain exopolyphosphatase. *Proc Natl Acad Sci U S A* **90**: 7029-7033.
- Kiel, C., E. Yus and L. Serrano. (2010) Engineering signal transduction pathways. *Cell* **140**: 33-47.
- Kirillina, O., J. D. Fetherston, A. G. Bobrov, J. Abney and R. D. Perry. (2004) HmsP, a putative phosphodiesterase, and HmsT, a putative diguanylate cyclase, control Hms-dependent biofilm formation in *Yersinia pestis*. *Mol Microbiol* **54**: 75-88.
- Klebensberger, J., A. Birkenmaier, R. Geffers, S. Kjelleberg and B. Philipp. (2009) SiaA and SiaD are essential for inducing autoaggregation as a specific response to detergent stress in *Pseudomonas aeruginosa*. *Environ Microbiol* **11**: 3073-3086.

- Ko, J., K. S. Ryu, H. Kim, J. S. Shin, J. O. Lee, C. Cheong and B. S. Choi. (2010) Structure of PP4397 reveals the molecular basis for different c-di-GMP binding modes by Pilz domain proteins. *J Mol Biol* **398**: 97-110.
- Koiv, V. and A. Mae. (2001) Quorum sensing controls the synthesis of virulence factors by modulating *rsmA* gene expression in *Erwinia carotovora* subsp. *carotovora*. *Mol Genet Genomics* **265**: 287-292.
- Kok, J., K. A. Trach and J. A. Hoch. (1994) Effects on *Bacillus subtilis* of a conditional lethal mutation in the essential GTP-binding protein Obg. *J Bacteriol* **176**: 7155-7160.
- Krasny, L. and R. L. Gourse. (2004) An alternative strategy for bacterial ribosome synthesis: *Bacillus subtilis* rRNA transcription regulation. *EMBO J* **23**: 4473-4483.
- Krasteva, P. V., J. C. Fong, N. J. Shikuma, S. Beyhan, M. V. Navarro, F. H. Yildiz and H. Sondermann. (2010) *Vibrio cholerae* VpsT regulates matrix production and motility by directly sensing cyclic di-GMP. *Science* **327**: 866-868.
- Kulkarni, P. R., X. Cui, J. W. Williams, A. M. Stevens and R. V. Kulkarni. (2006) Prediction of CsrA-regulating small RNAs in bacteria and their experimental verification in *Vibrio fischeri*. *Nucleic Acids Res* **34**: 3361-3369.
- Kumar, M. and D. Chatterji. (2008) Cyclic di-GMP: a second messenger required for long-term survival, but not for biofilm formation, in *Mycobacterium smegmatis*. *Microbiology* **154**: 2942-2955.

- Kuo, S., B. Demeler and W. G. Haldenwang. (2008) The growth-promoting and stress response activities of the *Bacillus subtilis* GTP binding protein Obg are separable by mutation. *J Bacteriol* **190**: 6625-6635.
- Kvint, K., A. Farewell and T. Nystrom. (2000) RpoS-dependent promoters require guanosine tetraphosphate for induction even in the presence of high levels of sigma(s). *J Biol Chem* **275**: 14795-14798.
- Lange, R., D. Fischer and R. Hengge-Aronis. (1995) Identification of transcriptional start sites and the role of ppGpp in the expression of *rpoS*, the structural gene for the sigma S subunit of RNA polymerase in *Escherichia coli*. *J Bacteriol* **177**: 4676-4680.
- Laptenko, O., J. Lee, I. Lomakin and S. Borukhov. (2003) Transcript cleavage factors GreA and GreB act as transient catalytic components of RNA polymerase. *EMBO J* **22**: 6322-6334.
- Laurie, A. D., L. M. D. Bernardo, C. C. Sze, E. Skarfstad, A. Szalewska-Palasz, T. Nystrom and V. Shingler. (2003) The role of the alarmone (p)ppGpp in sigma(N) competition for core RNA polymerase. *Journal of Biological Chemistry* **278**: 1494-1503.
- Lawhon, S. D., J. G. Frye, M. Suyemoto, S. Porwollik, M. McClelland and C. Altier. (2003) Global regulation by CsrA in *Salmonella typhimurium*. *Mol Microbiol* **48**: 1633-1645.
- Lee, E. R., J. L. Baker, Z. Weinberg, N. Sudarsan and R. R. Breaker. (2010) An allosteric self-splicing ribozyme triggered by a bacterial second messenger. *Science* **329**: 845-848.

- Lee, V. T., J. M. Matewish, J. L. Kessler, M. Hyodo, Y. Hayakawa and S. Lory. (2007) A cyclic-di-GMP receptor required for bacterial exopolysaccharide production. *Mol Microbiol* **65**: 1474-1484.
- Lemos, J. A., T. A. Brown, Jr. and R. A. Burne. (2004) Effects of RelA on key virulence properties of planktonic and biofilm populations of *Streptococcus mutans*. *Infect Immun* **72**: 1431-1440.
- Lemos, J. A., V. K. Lin, M. M. Nascimento, J. Abranches and R. A. Burne. (2007) Three gene products govern (p)ppGpp production by *Streptococcus mutans*. *Mol Microbiol* **65**: 1568-1581.
- Lemos, J. A., M. M. Nascimento, V. K. Lin, J. Abranches and R. A. Burne. (2008) Global regulation by (p)ppGpp and CodY in *Streptococcus mutans*. *J Bacteriol* **190**: 5291-5299.
- Lennon, C. W., T. Gaal, W. Ross and R. L. Gourse. (2009) *Escherichia coli* DksA binds to Free RNA polymerase with higher affinity than to RNA polymerase in an open complex. *J Bacteriol* **191**: 5854-5858.
- Lenz, D. H., M. B. Miller, J. Zhu, R. V. Kulkarni and B. L. Bassler. (2005) CsrA and three redundant small RNAs regulate quorum sensing in *Vibrio cholerae*. *Mol Microbiol* **58**: 1186-1202.
- Levine, A., F. Vannier, M. Dehbi, G. Henckes and S. J. Seror. (1991) The stringent response blocks DNA replication outside the ori region in *Bacillus subtilis* and at the origin in *Escherichia coli*. *J Mol Biol* **219**: 605-613.

- Liaw, S. J., H. C. Lai, S. W. Ho, K. T. Luh and W. B. Wang. (2003) Role of RsmA in the regulation of swarming motility and virulence factor expression in *Proteus mirabilis*. *J Med Microbiol* **52**: 19-28.
- Lin, B., K. L. Covalle and J. R. Maddock. (1999) The *Caulobacter crescentus* CgtA protein displays unusual guanine nucleotide binding and exchange properties. *J Bacteriol* **181**: 5825-5832.
- Lin, B., D. A. Thayer and J. R. Maddock. (2004) The *Caulobacter crescentus* CgtAC protein cosediments with the free 50S ribosomal subunit. *J Bacteriol* **186**: 481-489.
- Liu, M. Y., G. Gui, B. Wei, J. F. Preston, 3rd, L. Oakford, U. Yuksel, D. P. Giedroc and T. Romeo. (1997) The RNA molecule CsrB binds to the global regulatory protein CsrA and antagonizes its activity in *Escherichia coli*. *J Biol Chem* **272**: 17502-17510.
- Liu, M. Y. and T. Romeo. (1997) The global regulator CsrA of *Escherichia coli* is a specific mRNA-binding protein. *J Bacteriol* **179**: 4639-4642.
- Liu, M. Y., H. Yang and T. Romeo. (1995) The product of the pleiotropic *Escherichia coli* gene *csrA* modulates glycogen biosynthesis via effects on mRNA stability. *J Bacteriol* **177**: 2663-2672.
- Liu, X. and P. Matsumura. (1994) The FlhD/FlhC complex, a transcriptional activator of the *Escherichia coli* flagellar class II operons. *J Bacteriol* **176**: 7345-7351.
- Liu, Y., Y. Cui, A. Mukherjee and A. K. Chatterjee. (1998) Characterization of a novel RNA regulator of *Erwinia carotovora* ssp. *carotovora* that controls production of extracellular enzymes and secondary metabolites. *Mol Microbiol* **29**: 219-234.

- Liu, Y., G. Jiang, Y. Cui, A. Mukherjee, W. L. Ma and A. K. Chatterjee. (1999) kdgREcc negatively regulates genes for pectinases, cellulase, protease, HarpinEcc, and a global RNA regulator in *Erwinia carotovora* subsp. *carotovora*. *J Bacteriol* **181**: 2411-2421.
- Lopez, J. M., A. Dromerick and E. Freese. (1981) Response of guanosine 5'-triphosphate concentration to nutritional changes and its significance for *Bacillus subtilis* sporulation. *J Bacteriol* **146**: 605-613.
- Lorenz, C., T. Gesell, B. Zimmermann, U. Schoeberl, I. Bilusic, L. Rajkowitsch, C. Waldsich, A. von Haeseler and R. Schroeder. (2010) Genomic SELEX for Hfq-binding RNAs identifies genomic aptamers predominantly in antisense transcripts. *Nucleic Acids Res* **38**: 3794-3808.
- Lyzen, R., M. Kochanowska, G. Wegrzyn and A. Szalewska-Palasz. (2009) Transcription from bacteriophage lambda pR promoter is regulated independently and antagonistically by DksA and ppGpp. *Nucleic Acids Res* **37**: 6655-6664.
- Mackie, G. A. (1998) Ribonuclease E is a 5'-end-dependent endonuclease. *Nature* **395**: 720-723.
- Maeda, Y. T. and M. Sano. (2006) Regulatory dynamics of synthetic gene networks with positive feedback. *J Mol Biol* **359**: 1107-1124.
- Malke, H., K. Steiner, W. M. McShan and J. J. Ferretti. (2006) Linking the nutritional status of *Streptococcus pyogenes* to alteration of transcriptional gene expression: the action of CodY and RelA. *Int J Med Microbiol* **296**: 259-275.
- Martinez-Costa, O. H., M. A. Fernandez-Moreno and F. Malpartida. (1998) The *relA/spoT*-homologous gene in *Streptomyces coelicolor* encodes both ribosome-

dependent (p)ppGpp-synthesizing and -degrading activities. *J Bacteriol* **180**: 4123-4132.

Martinez-Wilson, H. F., R. Tamayo, A. D. Tischler, D. W. Lazinski and A. Camilli.

(2008) The *Vibrio cholerae* hybrid sensor kinase VieS contributes to motility and biofilm regulation by altering the cyclic diguanylate level. *J Bacteriol* **190**: 6439-6447.

Mechold, U., M. Cashel, K. Steiner, D. Gentry and H. Malke. (1996) Functional analysis of a *relA/spoT* gene homolog from *Streptococcus equisimilis*. *J Bacteriol* **178**: 1401-1411.

Mechold, U., H. Murphy, L. Brown and M. Cashel. (2002) Intramolecular regulation of the opposing (p)ppGpp catalytic activities of Rel(Seq), the Rel/Spo enzyme from *Streptococcus equisimilis*. *J Bacteriol* **184**: 2878-2888.

Mercante, J., A. N. Edwards, A. K. Dubey, P. Babitzke and T. Romeo. (2009) Molecular geometry of CsrA (RsmA) binding to RNA and its implications for regulated expression. *J Mol Biol* **392**: 511-528.

Mercante, J., K. Suzuki, X. Cheng, P. Babitzke and T. Romeo. (2006) Comprehensive alanine-scanning mutagenesis of *Escherichia coli* CsrA defines two subdomains of critical functional importance. *J Biol Chem* **281**: 31832-31842.

Merighi, M., V. T. Lee, M. Hyodo, Y. Hayakawa and S. Lory. (2007) The second messenger bis-(3'-5')-cyclic-GMP and its PilZ domain-containing receptor Alg44 are required for alginate biosynthesis in *Pseudomonas aeruginosa*. *Mol Microbiol* **65**: 876-895.

- Merrikh, H., A. E. Ferrazzoli and S. T. Lovett. (2009) Growth phase and (p)ppGpp control of IraD, a regulator of RpoS stability, in *Escherichia coli*. *J Bacteriol* **191**: 7436-7446.
- Metzger, S., E. Sarubbi, G. Glaser and M. Cashel. (1989) Protein sequences encoded by the *relA* and the *spoT* genes of *Escherichia coli* are interrelated. *J Biol Chem* **264**: 9122-9125.
- Minasov, G., S. Padavattan, L. Shuvalova, J. S. Brunzelle, D. J. Miller, A. Basle, C. Massa, F. R. Collart, T. Schirmer and W. F. Anderson. (2009) Crystal structures of YkuI and its complex with second messenger cyclic Di-GMP suggest catalytic mechanism of phosphodiester bond cleavage by EAL domains. *J Biol Chem* **284**: 13174-13184.
- Mittenhuber, G. (2001) Comparative genomics and evolution of genes encoding bacterial (p)ppGpp synthetases/hydrolases (the Rel, RelA and SpoT proteins). *J Mol Microbiol Biotechnol* **3**: 585-600.
- Mogull, S. A., L. J. Runyen-Janecky, M. Hong and S. M. Payne. (2001) *dksA* is required for intercellular spread of *Shigella flexneri* via an RpoS-independent mechanism. *Infect Immun* **69**: 5742-5751.
- Molle, V., Y. Nakaura, R. P. Shivers, H. Yamaguchi, R. Losick, Y. Fujita and A. L. Sonenshein. (2003) Additional targets of the *Bacillus subtilis* global regulator CodY identified by chromatin immunoprecipitation and genome-wide transcript analysis. *J Bacteriol* **185**: 1911-1922.

- Molofsky, A. B. and M. S. Swanson. (2003) *Legionella pneumophila* CsrA is a pivotal repressor of transmission traits and activator of replication. *Mol Microbiol* **50**: 445-461.
- Mondragon, V., B. Franco, K. Jonas, K. Suzuki, T. Romeo, O. Melefors and D. Georgellis. (2006) pH-dependent activation of the BarA-UvrY two-component system in *Escherichia coli*. *J Bacteriol* **188**: 8303-8306.
- Mukherjee, A., Y. Cui, W. Ma, Y. Liu and A. K. Chatterjee. (2000) *hexA* of *Erwinia carotovora* ssp. *carotovora* strain Ecc71 negatively regulates production of RpoS and *rsmB* RNA, a global regulator of extracellular proteins, plant virulence and the quorum-sensing signal, N-(3-oxohexanoyl)-L-homoserine lactone. *Environ Microbiol* **2**: 203-215.
- Mukherjee, A., Y. Cui, W. Ma, Y. Liu, A. Ishihama, A. Eisenstark and A. K. Chatterjee. (1998) RpoS (sigma-S) controls expression of *rsmA*, a global regulator of secondary metabolites, harpin, and extracellular proteins in *Erwinia carotovora*. *J Bacteriol* **180**: 3629-3634.
- Mukherjee, K., H. Nagai, N. Shimamoto and D. Chatterji. (1999) GroEL is involved in activation of *Escherichia coli* RNA polymerase devoid of the omega subunit in vivo. *Eur J Biochem* **266**: 228-235.
- Murphy, H. and M. Cashel. (2003) Isolation of RNA polymerase suppressors of a (p)ppGpp deficiency. *Methods Enzymol* **371**: 596-601.
- Murray, H. D., D. A. Schneider and R. L. Gourse. (2003) Control of rRNA expression by small molecules is dynamic and nonredundant. *Mol Cell* **12**: 125-134.

- Murray, K. D. and H. Bremer. (1996) Control of spoT-dependent ppGpp synthesis and degradation in *Escherichia coli*. *J Mol Biol* **259**: 41-57.
- Nanamiya, H., K. Kasai, A. Nozawa, C. S. Yun, T. Narisawa, K. Murakami, Y. Natori, F. Kawamura and Y. Tozawa. (2008) Identification and functional analysis of novel (p)ppGpp synthetase genes in *Bacillus subtilis*. *Mol Microbiol* **67**: 291-304.
- Navarro, M. V., N. De, N. Bae, Q. Wang and H. Sondermann. (2009) Structural analysis of the GGDEF-EAL domain-containing c-di-GMP receptor FimX. *Structure* **17**: 1104-1116.
- Nevozhay, D., R. M. Adams, K. F. Murphy, K. Josic and G. Balazsi. (2009) Negative autoregulation linearizes the dose-response and suppresses the heterogeneity of gene expression. *Proc Natl Acad Sci U S A* **106**: 5123-5128.
- Newell, P. D., R. D. Monds and G. A. O'Toole. (2009) LapD is a bis-(3',5')-cyclic dimeric GMP-binding protein that regulates surface attachment by *Pseudomonas fluorescens* Pf0-1. *Proc Natl Acad Sci U S A* **106**: 3461-3466.
- Ochi, K. (1987) Changes in nucleotide pool during sporulation of *Streptomyces griseus* submerged culture. *J Gen Microbiol* **133**: 2787-2795.
- Ochi, K., J. Kandala and E. Freese. (1982) Evidence that *Bacillus subtilis* sporulation induced by the stringent response is caused by the decrease in GTP or GDP. *J Bacteriol* **151**: 1062-1065.
- Okamoto, S. and K. Ochi. (1998) An essential GTP-binding protein functions as a regulator for differentiation in *Streptomyces coelicolor*. *Mol Microbiol* **30**: 107-119.

- Park, J. W., Y. Jung, S. J. Lee, D. J. Jin and Y. Lee. (2002) Alteration of stringent response of the *Escherichia coli* rnpB promoter by mutations in the -35 region. *Biochem Biophys Res Commun* **290**: 1183-1187.
- Paul, B. J., M. M. Barker, W. Ross, D. A. Schneider, C. Webb, J. W. Foster and R. L. Gourse. (2004a) DksA: a critical component of the transcription initiation machinery that potentiates the regulation of rRNA promoters by ppGpp and the initiating NTP. *Cell* **118**: 311-322.
- Paul, B. J., M. B. Berkmen and R. L. Gourse. (2005) DksA potentiates direct activation of amino acid promoters by ppGpp. *Proc Natl Acad Sci U S A* **102**: 7823-7828.
- Paul, K., V. Nieto, W. C. Carlquist, D. F. Blair and R. M. Harshey. (2010) The c-di-GMP binding protein YcgR controls flagellar motor direction and speed to affect chemotaxis by a "backstop brake" mechanism. *Mol Cell* **38**: 128-139.
- Paul, R., S. Abel, P. Wassmann, A. Beck, H. Heerklotz and U. Jenal. (2007) Activation of the diguanylate cyclase PleD by phosphorylation-mediated dimerization. *J Biol Chem* **282**: 29170-29177.
- Paul, R., S. Weiser, N. C. Amiot, C. Chan, T. Schirmer, B. Giese and U. Jenal. (2004b) Cell cycle-dependent dynamic localization of a bacterial response regulator with a novel di-guanylate cyclase output domain. *Genes Dev* **18**: 715-727.
- Perederina, A., V. Svetlov, M. N. Vassylyeva, T. H. Tahirov, S. Yokoyama, I. Artsimovitch and D. G. Vassylyev. (2004) Regulation through the secondary channel--structural framework for ppGpp-DksA synergism during transcription. *Cell* **118**: 297-309.

- Pernestig, A. K., D. Georgellis, T. Romeo, K. Suzuki, H. Tomenius, S. Normark and O. Melefors. (2003) The *Escherichia coli* BarA-UvrY two-component system is needed for efficient switching between glycolytic and gluconeogenic carbon sources. *J Bacteriol* **185**: 843-853.
- Pernestig, A. K., O. Melefors and D. Georgellis. (2001) Identification of UvrY as the cognate response regulator for the BarA sensor kinase in *Escherichia coli*. *J Biol Chem* **276**: 225-231.
- Persky, N. S., D. J. Ferullo, D. L. Cooper, H. R. Moore and S. T. Lovett. (2009) The ObgE/CgtA GTPase influences the stringent response to amino acid starvation in *Escherichia coli*. *Mol Microbiol* **73**: 253-266.
- Pessi, G., F. Williams, Z. Hindle, K. Heurlier, M. T. Holden, M. Camara, D. Haas and P. Williams. (2001) The global posttranscriptional regulator RsmA modulates production of virulence determinants and N-acylhomoserine lactones in *Pseudomonas aeruginosa*. *J Bacteriol* **183**: 6676-6683.
- Potrykus, K., D. Vinella, H. Murphy, A. Szalewska-Palasz, R. D'Ari and M. Cashel. (2006) Antagonistic regulation of *Escherichia coli* ribosomal RNA *rrnB* P1 promoter activity by GreA and DksA. *J Biol Chem* **281**: 15238-15248.
- Pratt, J. T., R. Tamayo, A. D. Tischler and A. Camilli. (2007) PilZ domain proteins bind cyclic diguanylate and regulate diverse processes in *Vibrio cholerae*. *J Biol Chem* **282**: 12860-12870.
- Qi, Y., F. Rao, Z. Luo and Z. X. Liang. (2009) A flavin cofactor-binding PAS domain regulates c-di-GMP synthesis in AxDG2 from *Acetobacter xylinum*. *Biochemistry* **48**: 10275-10285.

- Ramagopal, S. and B. D. Davis. (1974) Localization of the stringent protein of *Escherichia coli* on the 50S ribosomal subunit. *Proc Natl Acad Sci U S A* **71**: 820-824.
- Ramelot, T. A., A. Yee, J. R. Cort, A. Semesi, C. H. Arrowsmith and M. A. Kennedy. (2007) NMR structure and binding studies confirm that PA4608 from *Pseudomonas aeruginosa* is a PilZ domain and a c-di-GMP binding protein. *Proteins* **66**: 266-271.
- Rao, F., Y. Qi, H. S. Chong, M. Kotaka, B. Li, J. Li, J. Lescar, K. Tang and Z. X. Liang. (2009) The functional role of a conserved loop in EAL domain-based cyclic di-GMP-specific phosphodiesterase. *J Bacteriol* **191**: 4722-4731.
- Rao, F., Y. Yang, Y. Qi and Z. X. Liang. (2008) Catalytic mechanism of cyclic di-GMP-specific phosphodiesterase: a study of the EAL domain-containing RocR from *Pseudomonas aeruginosa*. *J Bacteriol* **190**: 3622-3631.
- Rasis, M. and G. Segal. (2009) The LetA-RsmYZ-CsrA regulatory cascade, together with RpoS and PmrA, post-transcriptionally regulates stationary phase activation of *Legionella pneumophila* Icm/Dot effectors. *Mol Microbiol* **72**: 995-1010.
- Raskin, D. M., N. Judson and J. J. Mekalanos. (2007) Regulation of the stringent response is the essential function of the conserved bacterial G protein CgtA in *Vibrio cholerae*. *Proc Natl Acad Sci U S A* **104**: 4636-4641.
- Ratnayake-Lecamwasam, M., P. Serror, K. W. Wong and A. L. Sonenshein. (2001) *Bacillus subtilis* CodY represses early-stationary-phase genes by sensing GTP levels. *Genes Dev* **15**: 1093-1103.

- Reimmann, C., M. Beyeler, A. Latifi, H. Winteler, M. Foglino, A. Lazdunski and D. Haas. (1997) The global activator GacA of *Pseudomonas aeruginosa* PAO positively controls the production of the autoinducer N-butyryl-homoserine lactone and the formation of the virulence factors pyocyanin, cyanide, and lipase. *Mol Microbiol* **24**: 309-319.
- Reimmann, C., C. Valverde, E. Kay and D. Haas. (2005) Posttranscriptional repression of GacS/GacA-controlled genes by the RNA-binding protein RsmE acting together with RsmA in the biocontrol strain *Pseudomonas fluorescens* CHA0. *J Bacteriol* **187**: 276-285.
- Rich, J. J., T. G. Kinscherf, T. Kitten and D. K. Willis. (1994) Genetic evidence that the *gacA* gene encodes the cognate response regulator for the *lemA* sensor in *Pseudomonas syringae*. *J Bacteriol* **176**: 7468-7475.
- Richter, D. (1980) Uncharged tRNA inhibits guanosine 3',5'-bis (diphosphate) 3'-pyrophosphohydrolase [ppGppase], the *spoT* gene product, from *Escherichia coli*. *Mol Gen Genet* **178**: 325-327.
- Rife, C., R. Schwarzenbacher, D. McMullan, P. Abdubek, E. Ambing, H. Axelrod, T. Biorac, J. M. Canaves, H. J. Chiu, A. M. Deacon, M. DiDonato, M. A. Elsliger, A. Godzik, C. Grittini, S. K. Grzechnik, J. Hale, E. Hampton, G. W. Han, J. Haugen, M. Hornsby, L. Jaroszewski, H. E. Klock, E. Koesema, A. Kreusch, P. Kuhn, S. A. Lesley, M. D. Miller, K. Moy, E. Nigoghossian, J. Paulsen, K. Quijano, R. Reyes, E. Sims, G. Spraggon, R. C. Stevens, H. van den Bedem, J. Velasquez, J. Vincent, A. White, G. Wolf, Q. Xu, K. O. Hodgson, J. Wooley and I. A. Wilson. (2005) Crystal structure of the global regulatory protein CsrA from

- Pseudomonas putida* at 2.05 Å resolution reveals a new fold. *Proteins* **61**: 449-453.
- Rocha, E. P. (2004) The replication-related organization of bacterial genomes. *Microbiology* **150**: 1609-1627.
- Romeo, T., M. Gong, M. Y. Liu and A. M. Brun-Zinkernagel. (1993) Identification and molecular characterization of *csrA*, a pleiotropic gene from *Escherichia coli* that affects glycogen biosynthesis, gluconeogenesis, cell size, and surface properties. *J Bacteriol* **175**: 4744-4755.
- Romling, U. (2009) Rationalizing the evolution of EAL domain-based cyclic di-GMP-specific phosphodiesterases. *J Bacteriol* **191**: 4697-4700.
- Rosenfeld, N., M. B. Elowitz and U. Alon. (2002) Negative autoregulation speeds the response times of transcription networks. *J Mol Biol* **323**: 785-793.
- Ross, P., H. Weinhouse, Y. Aloni, D. Michaeli, P. Weinberger-Ohana, R. Mayer, S. Braun, E. de Vroom, G. A. van der Marel, J. H. van Boom and M. Benziman. (1987) Regulation of cellulose synthesis in *Acetobacter xylinum* by cyclic diguanylic acid. *Nature* **325**: 279-281.
- Rutherford, S. T., J. J. Lemke, C. E. Vrentas, T. Gaal, W. Ross and R. L. Gourse. (2007) Effects of DksA, GreA, and GreB on transcription initiation: insights into the mechanisms of factors that bind in the secondary channel of RNA polymerase. *J Mol Biol* **366**: 1243-1257.
- Rutherford, S. T., C. L. Villers, J. H. Lee, W. Ross and R. L. Gourse. (2009) Allosteric control of *Escherichia coli* rRNA promoter complexes by DksA. *Genes Dev* **23**: 236-248.

- Ryan, R. P., Y. Fouhy, J. F. Lucey, L. C. Crossman, S. Spiro, Y. W. He, L. H. Zhang, S. Heeb, M. Camara, P. Williams and J. M. Dow. (2006) Cell-cell signaling in *Xanthomonas campestris* involves an HD-GYP domain protein that functions in cyclic di-GMP turnover. *Proc Natl Acad Sci U S A* **103**: 6712-6717.
- Ryan, R. P., J. Lucey, K. O'Donovan, Y. McCarthy, L. Yang, T. Tolker-Nielsen and J. M. Dow. (2009) HD-GYP domain proteins regulate biofilm formation and virulence in *Pseudomonas aeruginosa*. *Environ Microbiol* **11**: 1126-1136.
- Ryan, R. P., Y. McCarthy, M. Andrade, C. S. Farah, J. P. Armitage and J. M. Dow. (2010) Cell-cell signal-dependent dynamic interactions between HD-GYP and GGDEF domain proteins mediate virulence in *Xanthomonas campestris*. *Proc Natl Acad Sci U S A* **107**: 5989-5994.
- Ryjenkov, D. A., R. Simm, U. Romling and M. Gomelsky. (2006) The PilZ domain is a receptor for the second messenger c-di-GMP: the PilZ domain protein YcgR controls motility in enterobacteria. *J Biol Chem* **281**: 30310-30314.
- Ryjenkov, D. A., M. Tarutina, O. V. Moskvina and M. Gomelsky. (2005) Cyclic diguanylate is a ubiquitous signaling molecule in bacteria: Insights into biochemistry of the GGDEF protein domain. *Journal of Bacteriology* **187**: 1792-1798.
- Sabnis, N. A., H. Yang and T. Romeo. (1995) Pleiotropic regulation of central carbohydrate metabolism in *Escherichia coli* via the gene *csrA*. *J Biol Chem* **270**: 29096-29104.

- Sahr, T., H. Bruggemann, M. Jules, M. Lomma, C. Albert-Weissenberger, C. Cazalet and C. Buchrieser. (2009) Two small ncRNAs jointly govern virulence and transmission in *Legionella pneumophila*. *Mol Microbiol*.
- Sato, A., G. Kobayashi, H. Hayashi, H. Yoshida, A. Wada, M. Maeda, S. Hiraga, K. Takeyasu and C. Wada. (2005) The GTP binding protein Obg homolog ObgE is involved in ribosome maturation. *Genes Cells* **10**: 393-408.
- Schilling-Bartetzko, S., F. Franceschi, H. Sternbach and K. H. Nierhaus. (1992) Apparent association constants of tRNAs for the ribosomal A, P, and E sites. *J Biol Chem* **267**: 4693-4702.
- Schirmer, T. and U. Jenal. (2009) Structural and mechanistic determinants of c-di-GMP signalling. *Nat Rev Microbiol* **7**: 724-735.
- Schmidt, A. J., D. A. Ryjenkov and M. Gomelsky. (2005) The ubiquitous protein domain EAL is a cyclic diguanylate-specific phosphodiesterase: enzymatically active and inactive EAL domains. *J Bacteriol* **187**: 4774-4781.
- Schneider, D. A. and R. L. Gourse. (2004) Relationship between growth rate and ATP concentration in *Escherichia coli*: a bioassay for available cellular ATP. *J Biol Chem* **279**: 8262-8268.
- Schroeder, C., K. Werner, H. Otten, S. Kratzig, H. Schwalbe and L. O. Essen. (2008) Influence of a joining helix on the BLUF domain of the YcgF photoreceptor from *Escherichia coli*. *Chembiochem* **9**: 2463-2473.
- Schubert, M., K. Lapouge, O. Duss, F. C. Oberstrass, I. Jelesarov, D. Haas and F. H. Allain. (2007) Molecular basis of messenger RNA recognition by the specific bacterial repressing clamp RsmA/CsrA. *Nat Struct Mol Biol* **14**: 807-813.

- Scott, J. M. and W. G. Haldenwang. (1999) Obg, an essential GTP binding protein of *Bacillus subtilis*, is necessary for stress activation of transcription factor sigma(B). *J Bacteriol* **181**: 4653-4660.
- Scott, J. M., J. Ju, T. Mitchell and W. G. Haldenwang. (2000) The *Bacillus subtilis* GTP binding protein obg and regulators of the sigma(B) stress response transcription factor cofractionate with ribosomes. *J Bacteriol* **182**: 2771-2777.
- Serror, P. and A. L. Sonenshein. (1996a) CodY is required for nutritional repression of *Bacillus subtilis* genetic competence. *J Bacteriol* **178**: 5910-5915.
- Serror, P. and A. L. Sonenshein. (1996b) Interaction of CodY, a novel *Bacillus subtilis* DNA-binding protein, with the *dpp* promoter region. *Mol Microbiol* **20**: 843-852.
- Seshasayee, A. S., G. M. Fraser and N. M. Luscombe. (2010) Comparative genomics of cyclic-di-GMP signalling in bacteria: post-translational regulation and catalytic activity. *Nucleic Acids Res.*
- Seyfzadeh, M., J. Keener and M. Nomura. (1993) spoT-dependent accumulation of guanosine tetraphosphate in response to fatty acid starvation in *Escherichia coli*. *Proc Natl Acad Sci U S A* **90**: 11004-11008.
- Shah, S., B. Das and R. K. Bhadra. (2008) Functional analysis of the essential GTP-binding-protein-coding gene *cgtA* of *Vibrio cholerae*. *J Bacteriol* **190**: 4764-4771.
- Shivers, R. P. and A. L. Sonenshein. (2004) Activation of the *Bacillus subtilis* global regulator CodY by direct interaction with branched-chain amino acids. *Mol Microbiol* **53**: 599-611.

- Sikora, A. E., R. Zielke, K. Datta and J. R. Maddock. (2006) The *Vibrio harveyi* GTPase CgtAV is essential and is associated with the 50S ribosomal subunit. *J Bacteriol* **188**: 1205-1210.
- Simm, R., M. Morr, A. Kader, M. Nimtz and U. Romling. (2004) GGDEF and EAL domains inversely regulate cyclic di-GMP levels and transition from sessility to motility. *Molecular Microbiology* **53**: 1123-1134.
- Sittka, A., S. Lucchini, K. Papenfort, C. M. Sharma, K. Rolle, T. T. Binnewies, J. C. Hinton and J. Vogel. (2008) Deep sequencing analysis of small noncoding RNA and mRNA targets of the global post-transcriptional regulator, Hfq. *PLoS Genet* **4**: e1000163.
- Sittka, A., C. M. Sharma, K. Rolle and J. Vogel. (2009) Deep sequencing of *Salmonella* RNA associated with heterologous Hfq proteins in vivo reveals small RNAs as a major target class and identifies RNA processing phenotypes. *RNA Biol* **6**: 266-275.
- Sjoblom, S., G. Brader, G. Koch and E. T. Palva. (2006) Cooperation of two distinct ExpR regulators controls quorum sensing specificity and virulence in the plant pathogen *Erwinia carotovora*. *Mol Microbiol* **60**: 1474-1489.
- Sommerfeldt, N., A. Possling, G. Becker, C. Pesavento, N. Tschowri and R. Hengge. (2009) Gene expression patterns and differential input into curli fimbriae regulation of all GGDEF/EAL domain proteins in *Escherichia coli*. *Microbiology* **155**: 1318-1331.

- Sonnleitner, E., M. Schuster, T. Sorger-Domenigg, E. P. Greenberg and U. Blasi. (2006) Hfq-dependent alterations of the transcriptome profile and effects on quorum sensing in *Pseudomonas aeruginosa*. *Mol Microbiol* **59**: 1542-1558.
- Sorger-Domenigg, T., E. Sonnleitner, V. R. Kaberdin and U. Blasi. (2007) Distinct and overlapping binding sites of *Pseudomonas aeruginosa* Hfq and RsmA proteins on the non-coding RNA RsmY. *Biochem Biophys Res Commun* **352**: 769-773.
- Srivatsan, A., A. Tehrani, D. M. MacAlpine and J. D. Wang. (2010) Co-orientation of replication and transcription preserves genome integrity. *PLoS Genet* **6**: e1000810.
- Stent, G. S. and S. Brenner. (1961) A genetic locus for the regulation of ribonucleic acid synthesis. *Proc Natl Acad Sci U S A* **47**: 2005-2014.
- Sudarsan, N., E. R. Lee, Z. Weinberg, R. H. Moy, J. N. Kim, K. H. Link and R. R. Breaker. (2008) Riboswitches in eubacteria sense the second messenger cyclic di-GMP. *Science* **321**: 411-413.
- Suzuki, K., P. Babitzke, S. R. Kushner and T. Romeo. (2006) Identification of a novel regulatory protein (CsrD) that targets the global regulatory RNAs CsrB and CsrC for degradation by RNase E. *Genes Dev* **20**: 2605-2617.
- Suzuki, K., X. Wang, T. Weilbacher, A. K. Pernestig, O. Melefors, D. Georgellis, P. Babitzke and T. Romeo. (2002) Regulatory circuitry of the CsrA/CsrB and BarA/UvrY systems of *Escherichia coli*. *J Bacteriol* **184**: 5130-5140.
- Sy, J. (1977) In vitro degradation of guanosine 5'-diphosphate, 3'-diphosphate. *Proc Natl Acad Sci U S A* **74**: 5529-5533.

- Szalewska-Palasz, A., L. U. Johansson, L. M. Bernardo, E. Skarfstad, E. Stec, K. Brannstrom and V. Shingler. (2007) Properties of RNA polymerase bypass mutants: implications for the role of ppGpp and its co-factor DksA in controlling transcription dependent on sigma54. *J Biol Chem* **282**: 18046-18056.
- Tagliabue, L., D. Antoniani, A. Maciag, P. Bocci, N. Raffaelli and P. Landini. (2010) The diguanylate cyclase YddV controls production of the exopolysaccharide poly-N-acetylglucosamine (PNAG) through regulation of the PNAG biosynthetic pgaABCD operon. *Microbiology*.
- Takahashi, K., K. Kasai and K. Ochi. (2004) Identification of the bacterial alarmone guanosine 5'-diphosphate 3'-diphosphate (ppGpp) in plants. *Proc Natl Acad Sci U S A* **101**: 4320-4324.
- Tal, R., H. C. Wong, R. Calhoon, D. Gelfand, A. L. Fear, G. Volman, R. Mayer, P. Ross, D. Amikam, H. Weinhouse, A. Cohen, S. Sapir, P. Ohana and M. Benziman. (1998) Three cdg operons control cellular turnover of cyclic di-GMP in *Acetobacter xylinum*: genetic organization and occurrence of conserved domains in isoenzymes. *J Bacteriol* **180**: 4416-4425.
- Tamayo, R., S. Schild, J. T. Pratt and A. Camilli. (2008) Role of cyclic Di-GMP during enterobiotype *Vibrio cholerae* infection: characterization of the in vivo-induced cyclic Di-GMP phosphodiesterase CdpA. *Infect Immun* **76**: 1617-1627.
- Tamayo, R., A. D. Tischler and A. Camilli. (2005) The EAL domain protein VieA is a cyclic diguanylate phosphodiesterase. *J Biol Chem* **280**: 33324-33330.

- Tarutina, M., D. A. Ryjenkov and M. Gomelsky. (2006) An unorthodox bacteriophytochrome from *Rhodobacter sphaeroides* involved in turnover of the second messenger c-di-GMP. *J Biol Chem* **281**: 34751-34758.
- Tehranchi, A. K., M. D. Blankschien, Y. Zhang, J. A. Halliday, A. Srivatsan, J. Peng, C. Herman and J. D. Wang. (2010) The transcription factor DksA prevents conflicts between DNA replication and transcription machinery. *Cell* **141**: 595-605.
- Teplitski, M., R. I. Goodier and B. M. Ahmer. (2003) Pathways leading from BarA/SirA to motility and virulence gene expression in *Salmonella*. *J Bacteriol* **185**: 7257-7265.
- Teplitski, M., R. I. Goodier and B. M. Ahmer. (2006) Catabolite repression of the SirA regulatory cascade in *Salmonella enterica*. *Int J Med Microbiol* **296**: 449-466.
- Timmermans, J. and L. Van Melderen. (2009) Conditional essentiality of the *csrA* gene in *Escherichia coli*. *J Bacteriol* **191**: 1722-1724.
- Tischler, A. D. and A. Camilli. (2004) Cyclic diguanylate (c-di-GMP) regulates *Vibrio cholerae* biofilm formation. *Molecular Microbiology* **53**: 857-869.
- Trautinger, B. W. and R. G. Lloyd. (2002) Modulation of DNA repair by mutations flanking the DNA channel through RNA polymerase. *EMBO J* **21**: 6944-6953.
- Travers, A. A. (1980) Promoter sequence for stringent control of bacterial ribonucleic acid synthesis. *J Bacteriol* **141**: 973-976.
- Travers, A. A., (1984) Conserved features of coordinately regulated *E. coli* promoters. *Nucleic Acids Res* **12**: 2605-2618.

- Tschowri, N., S. Busse and R. Hengge. (2009) The BLUF-EAL protein YcgF acts as a direct anti-repressor in a blue-light response of *Escherichia coli*. *Genes Dev* **23**: 522-534.
- Tu, K. C., T. Long, S. L. Svenningsen, N. S. Wingreen and B. L. Bassler. (2010) Negative feedback loops involving small regulatory RNAs precisely control the *Vibrio harveyi* quorum-sensing response. *Mol Cell* **37**: 567-579.
- Valverde, C., S. Heeb, C. Keel and D. Haas. (2003) RsmY, a small regulatory RNA, is required in concert with RsmZ for GacA-dependent expression of biocontrol traits in *Pseudomonas fluorescens* CHA0. *Mol Microbiol* **50**: 1361-1379.
- van der Biezen, E. A., J. Sun, M. J. Coleman, M. J. Bibb and J. D. Jones. (2000) *Arabidopsis* RelA/SpoT homologs implicate (p)ppGpp in plant signaling. *Proc Natl Acad Sci U S A* **97**: 3747-3752.
- Vassilyeva, M. N., A. A. Perederina, V. Svetlov, S. Yokoyama, I. Artsimovitch and D. G. Vassilyev. (2004) Cloning, expression, purification, crystallization and initial crystallographic analysis of transcription factor DksA from *Escherichia coli*. *Acta Crystallogr D Biol Crystallogr* **60**: 1611-1613.
- Ventre, I., A. L. Goodman, I. Vallet-Gely, P. Vasseur, C. Soscia, S. Molin, S. Bleves, A. Lazdunski, S. Lory and A. Filloux. (2006) Multiple sensors control reciprocal expression of *Pseudomonas aeruginosa* regulatory RNA and virulence genes. *Proc Natl Acad Sci U S A* **103**: 171-176.
- Vidwans, S. J., K. Ireton and A. D. Grossman. (1995) Possible role for the essential GTP-binding protein Obg in regulating the initiation of sporulation in *Bacillus subtilis*. *J Bacteriol* **177**: 3308-3311.

- Vinella, D., C. Albrecht, M. Cashel and R. D'Ari. (2005) Iron limitation induces SpoT-dependent accumulation of ppGpp in *Escherichia coli*. *Mol Microbiol* **56**: 958-970.
- Vrentas, C. E., T. Gaal, M. B. Berkmen, S. T. Rutherford, S. P. Haugen, D. G. Vassylyev, W. Ross and R. L. Gourse. (2008) Still looking for the magic spot: the crystallographically defined binding site for ppGpp on RNA polymerase is unlikely to be responsible for rRNA transcription regulation. *J Mol Biol* **377**: 551-564.
- Vrentas, C. E., T. Gaal, W. Ross, R. H. Ebright and R. L. Gourse. (2005) Response of RNA polymerase to ppGpp: requirement for the omega subunit and relief of this requirement by DksA. *Genes Dev* **19**: 2378-2387.
- Wang, J. D., G. M. Sanders and A. D. Grossman. (2007) Nutritional control of elongation of DNA replication by (p)ppGpp. *Cell* **128**: 865-875.
- Wang, X., A. K. Dubey, K. Suzuki, C. S. Baker, P. Babitzke and T. Romeo. (2005) CsrA post-transcriptionally represses *pgaABCD*, responsible for synthesis of a biofilm polysaccharide adhesin of *Escherichia coli*. *Mol Microbiol* **56**: 1648-1663.
- Wassmann, P., C. Chan, R. Paul, A. Beck, H. Heerklotz, U. Jenal and T. Schirmer. (2007) Structure of BeF3⁻-modified response regulator PleD: implications for diguanylate cyclase activation, catalysis, and feedback inhibition. *Structure* **15**: 915-927.
- Waters, C. M., W. Lu, J. D. Rabinowitz and B. L. Bassler. (2008) Quorum sensing controls biofilm formation in *Vibrio cholerae* through modulation of cyclic di-GMP levels and repression of *vpsT*. *J Bacteriol* **190**: 2527-2536.

- Waters, L. S. and G. Storz. (2009) Regulatory RNAs in bacteria. *Cell* **136**: 615-628.
- Webb, C., M. Moreno, M. Wilmes-Riesenberg, R. Curtiss, 3rd and J. W. Foster. (1999) Effects of DksA and ClpP protease on sigma S production and virulence in *Salmonella typhimurium*. *Mol Microbiol* **34**: 112-123.
- Wei, B., S. Shin, D. LaPorte, A. J. Wolfe and T. Romeo. (2000) Global regulatory mutations in *csrA* and *rpoS* cause severe central carbon stress in *Escherichia coli* in the presence of acetate. *J Bacteriol* **182**: 1632-1640.
- Wei, B. L., A. M. Brun-Zinkernagel, J. W. Simecka, B. M. Pruss, P. Babitzke and T. Romeo. (2001) Positive regulation of motility and *flhDC* expression by the RNA-binding protein CsrA of *Escherichia coli*. *Mol Microbiol* **40**: 245-256.
- Weilbacher, T., K. Suzuki, A. K. Dubey, X. Wang, S. Gudapaty, I. Morozov, C. S. Baker, D. Georgellis, P. Babitzke and T. Romeo. (2003) A novel sRNA component of the carbon storage regulatory system of *Escherichia coli*. *Mol Microbiol* **48**: 657-670.
- Weinhouse, H., S. Sapir, D. Amikam, Y. Shilo, G. Volman, P. Ohana and M. Benziman. (1997) c-di-GMP-binding protein, a new factor regulating cellulose synthesis in *Acetobacter xylinum*. *FEBS Lett* **416**: 207-211.
- Welsh, K. M., K. A. Trach, C. Folger and J. A. Hoch. (1994) Biochemical characterization of the essential GTP-binding protein Obg of *Bacillus subtilis*. *J Bacteriol* **176**: 7161-7168.
- Wendrich, T. M., G. Blaha, D. N. Wilson, M. A. Marahiel and K. H. Nierhaus. (2002) Dissection of the mechanism for the stringent factor RelA. *Mol Cell* **10**: 779-788.

- Wendrich, T. M. and M. A. Marahiel. (1997) Cloning and characterization of a *relA*/*spoT* homologue from *Bacillus subtilis*. *Mol Microbiol* **26**: 65-79.
- Wolfe, A. J. and K. L. Visick. (2008) Get the message out: cyclic-Di-GMP regulates multiple levels of flagellum-based motility. *J Bacteriol* **190**: 463-475.
- Wout, P., K. Pu, S. M. Sullivan, V. Reese, S. Zhou, B. Lin and J. R. Maddock. (2004) The *Escherichia coli* GTPase CgtAE cofractionates with the 50S ribosomal subunit and interacts with SpoT, a ppGpp synthetase/hydrolase. *J Bacteriol* **186**: 5249-5257.
- Wu, Q. and K. H. Gardner. (2009) Structure and insight into blue light-induced changes in the BlrP1 BLUF domain. *Biochemistry* **48**: 2620-2629.
- Xiao, H., M. Kalman, K. Ikehara, S. Zemel, G. Glaser and M. Cashel. (1991) Residual guanosine 3',5'-bispyrophosphate synthetic activity of *relA* null mutants can be eliminated by *spoT* null mutations. *J Biol Chem* **266**: 5980-5990.
- Yakhnin, H., P. Pandit, T. J. Petty, C. S. Baker, T. Romeo and P. Babitzke. (2007) CsrA of *Bacillus subtilis* regulates translation initiation of the gene encoding the flagellin protein (*hag*) by blocking ribosome binding. *Mol Microbiol* **64**: 1605-1620.
- Yamanaka, K., T. Mitani, T. Ogura, H. Niki and S. Hiraga. (1994) Cloning, sequencing, and characterization of multicopy suppressors of a *mukB* mutation in *Escherichia coli*. *Mol Microbiol* **13**: 301-312.
- Yang, H., M. Y. Liu and T. Romeo. (1996) Coordinate genetic regulation of glycogen catabolism and biosynthesis in *Escherichia coli* via the CsrA gene product. *J Bacteriol* **178**: 1012-1017.

- Yang, T. Y., Y. M. Sung, G. S. Lei, T. Romeo and K. F. Chak. (2010) Posttranscriptional repression of the *cel* gene of the ColE7 operon by the RNA-binding protein CsrA of *Escherichia coli*. *Nucleic Acids Res.*
- Yang, X. and E. E. Ishiguro. (2001) Involvement of the N terminus of ribosomal protein L11 in regulation of the RelA protein of *Escherichia coli*. *J Bacteriol* **183**: 6532-6537.
- Zhou, Y. N. and D. J. Jin. (1998) The *rpoB* mutants destabilizing initiation complexes at stringently controlled promoters behave like "stringent" RNA polymerases in *Escherichia coli*. *Proc Natl Acad Sci U S A* **95**: 2908-2913.

Chapter 2. Circuitry Linking the Csr and Stringent Response

Global Regulatory Systems

Adrienne N. Edwards¹, Laura Patterson-Fortin², Christopher A. Vakulskas², Jeffrey W. Mercante¹, Katarzyna Potrykus³, Martha I. Camacho⁴, Joshua A. Fields⁵, Stuart A. Thompson⁵, Dimitris Georgellis⁴, Michael Cashel³, Paul Babitzke⁶, and Tony Romeo^{1,2§}

¹Department of Microbiology and Immunology, Emory University School of Medicine, Atlanta, GA 30322, USA, ²Department of Microbiology and Cell Science, University of Florida, Gainesville, FL 32611, USA, ³Laboratory of Molecular Genetics, NICHD, NIH, Bethesda, MA 20892, USA, ⁴Departamento de Genética Molecular, Instituto de Fisiología Celular, Universidad Nacional Autónoma de México, Mexico City, Mexico, ⁵Department of Biochemistry and Molecular Biology, Medical College of Georgia, Augusta, GA 30912, USA, ⁶Department of Biochemistry and Molecular Biology, Pennsylvania State University, University Park, PA 16802, USA, §Corresponding Author: Fax: 1 (352) 392-5922. Phone: 1 (352) 392-2400. Email: tromeo@ufl.edu

This chapter consists of a manuscript submitted to *Molecular Microbiology*. The manuscript was written by Adrienne N. Edwards and Tony Romeo. Laura Patterson-Fortin constructed the CRIM plasmids used for construction of *lacZ* fusions. Christopher A. Vakulskas performed the CsrB and CsrC Northern blots. Jeffery W. Mercante provided technical assistance. Katarzyna Potrykus performed the *dkxA* primer extension. All remaining experiments were performed by Adrienne N. Edwards.

ABSTRACT

CsrA protein regulates several important cellular processes by binding to target mRNAs and altering their translation and/or stability. In *Escherichia coli*, CsrA binds to sRNAs, CsrB and CsrC, which sequester CsrA and antagonize its activity. In this study, RNA that copurified with CsrA (CsrA-His₆) was analyzed by high throughput sequencing. Among the 721 transcripts identified were *relA*, *spoT* and *dksA* of the stringent response system. Gel shift assays confirmed specific, high affinity binding of CsrA to the *relA* mRNA leader and weaker interactions with *dksA* and *spoT*. Studies using reporter fusions, qRT-PCR, and Western blotting revealed that CsrA posttranscriptionally repressed *relA*. CsrA did not affect a reporter fusion containing the *spoT* mRNA leader, although it lowered *spoT* transcript levels. While CsrA activated a *dksA*'-'*lacZ* translational fusion, *dksA* transcription was negatively autoregulated via a feedback loop that masked the effects of CsrA. DksA and ppGpp modestly activated CsrA, but robustly activated CsrB/C RNAs. Epistasis studies indicated that DksA and CsrA were both required for transcription of *csrB* and *csrC* by the response regulator UvrY. Our findings suggest that this composite network tightens the regulation of target genes responding to both systems and that the Csr system fine-tunes the stringent response.

INTRODUCTION

Bacteria utilize genetic regulatory mechanisms to adapt, compete and survive in response to changing environmental and physiological conditions. Moreover, global regulatory networks permit bacteria to coordinate expression of large sets of genes in multiple operons (Gottesman, 1984, Beisel and Storz, 2010). Two global regulatory

networks, Csr (carbon storage regulator) and stringent response, provide mechanisms for sensing end products of carbon metabolism and nutrient availability, and regulating translation and transcription, respectively (Babitzke and Romeo, 2007, Chavez *et al.*, 2010, Potrykus and Cashel, 2008).

CsrA (and its orthologs, RsmA/E) is a small, dimeric RNA binding protein that post-transcriptionally coordinates expression of a diverse set of genes by positively or negatively regulating the translation and/or stability of target transcripts. In this way, CsrA activates exponential phase processes while repressing several stationary phase functions (Babitzke and Romeo, 2007). CsrA is widely distributed among eubacteria (White *et al.*, 1996, Mercante *et al.*, 2006) and regulates expression of genes for virulence factors (Fortune *et al.*, 2006, Bhatt *et al.*, 2009b), quorum sensing (Cui *et al.*, 1995, Lenz *et al.*, 2005), motility (Wei *et al.*, 2001, Yakhnin *et al.*, 2007), carbon metabolism (Romeo *et al.*, 1993, Sabnis *et al.*, 1995), biofilm formation (Jackson *et al.*, 2002, Wang *et al.*, 2005), cyclic di-GMP synthesis (Jonas *et al.*, 2008) and peptide uptake (Dubey *et al.*, 2003).

CsrA directly regulates gene expression by interacting with the 5' untranslated leaders of target mRNAs at sites characterized by a GGA sequence that is often located within the loop of a short stem-loop structure (Liu *et al.*, 1997, Dubey *et al.*, 2005, Schubert *et al.*, 2007). CsrA typically represses translation initiation by binding at sites that overlap the Shine-Dalgarno sequence (SD), thus competing with the 30S ribosomal subunit and accelerating mRNA degradation (Liu and Romeo, 1997, Baker *et al.*, 2002, Dubey *et al.*, 2003). CsrA can also activate gene expression by stabilizing a bound transcript, as exemplified by the *E. coli flhDC* mRNA (Wei *et al.*, 2001).

The *E. coli* Csr system includes other important regulatory components. CsrB and CsrC are noncoding RNAs that contain multiple CsrA binding sites, which permit them to sequester and antagonize CsrA (Liu *et al.*, 1997, Weilbacher *et al.*, 2003). Transcription of these sRNAs is activated by the two-component signal transduction system (TCS), BarA-UvrY (Suzuki *et al.*, 2002, Weilbacher *et al.*, 2003). Recently, acetate was identified as a physiological stimulus for BarA-dependent signaling (Chavez *et al.*, 2010). This finding suggested a negative feedback loop whereby CsrA activates glycolysis (Sabnis *et al.*, 1995), a major source of acetate, and thus indirectly activates *csrB* and *csrC* transcription (Suzuki *et al.*, 2002, Weilbacher *et al.*, 2003). CsrA participates in at least two other negative feedback loops. CsrA represses expression of *csrD*, which encodes a GGDEF-EAL domain protein that functions along with RNase E and PNPase to mediate CsrB/C turnover (Suzuki *et al.*, 2006). CsrA also binds to the *csrA* mRNA leader and represses its own translation (H. Yakhnin and P. Babitzke, unpublished data).

The stringent response defines another global regulatory network of eubacteria. It is characterized by a rapid downshift in synthesis of stable RNAs, such as rRNA and tRNA, and the upregulation of a number of operons, such as those for amino acid biosynthesis, in response to starvation for amino acids or other nutrients (Potrykus and Cashel, 2008). The effector of this response is the nucleotide secondary messenger guanosine tetraphosphate (ppGpp) (Cashel and Gallant, 1969), which binds to RNA polymerase and positively or negatively affects transcription, depending upon promoter characteristics (Barker *et al.*, 2001). In *E. coli*, ppGpp levels are regulated by two enzymes: RelA and SpoT. RelA is a monofunctional pppGpp/ppGpp synthetase, which

responds to the presence of uncharged tRNA in the ribosomal A-site (Wendrich *et al.*, 2002). SpoT is a bifunctional synthetase/hydrolase, which exhibits weak ppGpp synthetase activity and serves primarily to degrade ppGpp (Cashel *et al.*, 1996). However, SpoT synthesizes ppGpp in response to carbon starvation (Cashel *et al.*, 1996), fatty acid starvation (Seyfzadeh *et al.*, 1993, Gong *et al.*, 2002) and other stresses, such as iron limitation (Vinella *et al.*, 2005).

In most cases, regulation by ppGpp requires the transcription factor DksA (Paul *et al.*, 2004a, Paul *et al.*, 2005), which interacts with the secondary channel of RNA polymerase (Paul *et al.*, 2004a, Perederina *et al.*, 2004). Together, ppGpp and DksA regulate the expression or activity of a number of global regulators, including the stationary phase sigma factor RpoS (Brown *et al.*, 2002), the extracytoplasmic sigma factor RpoE (Costanzo *et al.*, 2008) and the master regulator of the motility cascade, FlhD₄C₂ (Lemke *et al.*, 2009).

Here, we used high throughput sequencing to search for novel, direct targets of CsrA regulation. Among the transcripts identified by our screen were *relA*, *spoT* and *dksA*, which encode proteins that mediate the stringent response. In addition, we developed a reporter system for monitoring post-transcriptional regulation and used this and other approaches to reveal regulatory connections between the Csr and stringent response systems. Our findings reveal complex interactions between the Csr and stringent response systems, which likely allow fine tuning of gene expression by coupling global regulatory responses to substrate availability and end product accumulation. These interconnections may be designed in part to reinforce the direct effects of DksA and ppGpp on transcription of target genes by mediating indirect effects on the post-

transcriptional regulation of these genes by the Csr system. Our data also raise the possibility that the Csr system affects the magnitude of stringent response under certain conditions.

RESULTS

Screening for novel targets of CsrA binding. Several studies suggest that CsrA regulates expression of a large number of transcripts (Lawhon *et al.*, 2003, Burrowes *et al.*, 2006, Brencic and Lory, 2009). Data from these studies were primarily derived from transcriptome analyses, which in large part, did not exclude effects of indirect regulation or examine expression from intergenic regions. To screen for putative direct targets of CsrA binding, recombinant His-tagged CsrA (CsrA-His₆) was ectopically expressed and purified from a *csrA csrB csrC* triple mutant. RNA that was noncovalently bound to CsrA-His₆ was isolated, converted to cDNA, and analyzed by 454 sequencing (Margulies *et al.*, 2005). The results of this analysis suggested that CsrA binds to the RNAs of at least 721 genes (Appendix, Table 1), representing many fundamental physiological and regulatory processes, including the stringent response (Table 2-1). As an additional screen for potential targets of CsrA regulation, proteins from *csrA* mutant and wild-type strains were harvested under four growth conditions and identified by two-dimensional PAGE and MALDI-ToF/ToF mass spectrometry (Appendix, Table 2). Although some of these abundant proteins may not represent directly regulated targets of CsrA, transcripts of several of these proteins also copurified with CsrA (Appendix, Table 3).

CsrA binds to *relA* and *dksA* mRNA leaders with high affinity and specificity.

We found that CsrA-His₆ copurified with *relA*, *spoT*, and *dksA* transcripts. The mRNA

leader of *relA* contains six putative CsrA binding sites, while the mRNA leader of *dksA* contains two (Fig. 1A). To determine whether CsrA binds directly to *relA* and *dksA* transcripts, gel shift assays were performed with CsrA protein and in vitro synthesized transcripts containing the 5' untranslated region and part of the coding region of *relA* (+1 to +200 relative to the start of transcription) and *dksA* (+1 to +64 relative to the start of transcription). CsrA binding was initially observed at 5 to 10 nM CsrA for *relA* and at 10 nM CsrA for *dksA* (Fig. 1C, E). As the concentration of CsrA was increased further, additional shifted species were observed for the CsrA-*relA* interaction, suggesting that multiple CsrA proteins were bound to each *relA* transcript at the higher concentrations of CsrA. A nonlinear least-squares analysis of these data yielded apparent K_d values of 17 ± 1 nM CsrA for *relA* and 66 ± 4 nM CsrA for *dksA*.

The specificity of the CsrA-RNA interactions was investigated by performing competition experiments with specific (*relA* and *dksA*) and nonspecific (*Bacillus subtilis trp* leader) unlabeled RNA competitors. *relA* was an effective competitor, whereas the *B. subtilis trp* leader RNA did not compete with the CsrA-*relA* RNA interaction, confirming that CsrA binds to the *relA* mRNA leader with high affinity and specificity (Fig. 1C, D). *dksA* was also an effective competitor for the CsrA-*dksA* RNA interaction. However, in this case, the *B. subtilis trp* leader RNA exhibited weak competition, indicating that the affinity and specificity of the CsrA-*dksA* RNA interaction is not as strong (Fig. 1F).

Analyses of CsrA binding to *gmk* and *rpoZ* mRNA leaders. *spoT* is located within the five gene *spo* operon, *gmk-rpoZ-spoT-trmH-recG*, which is transcribed by three mapped promoters (Gentry *et al.*, 1993; Fig. 1B). Sequence analysis identified a possible CsrA binding site, with modest similarity to consensus, overlapping the *gmk* SD

sequence, and two putative CsrA binding sites in *rpoZ*, one of which overlaps the SD sequence (Fig. 1A, B). Gel shift assays with transcripts containing the 5' untranslated leader and part of the coding region of *gmk* (-42 nt to +25 nt) and *rpoZ* (-28 nt to +33 nt) were used to assess binding. CsrA did not interact with the *gmk* transcript (Fig. 1G) but bound to the *rpoZ* transcript, beginning at 5 to 10 nM CsrA, resulting in an apparent K_d value of 66 ± 4 nM (Fig. 1H).

Experiments with specific (*rpoZ*) and nonspecific (*B. subtilis trp*) unlabeled RNA competitors revealed that *rpoZ* RNA competed effectively for the CsrA-*rpoZ* interaction (Fig. 1I). *trp* leader RNA was also able to compete, although not as effectively as *rpoZ* RNA (Fig. 1I), implying that CsrA interacts with modest specificity to the *rpoZ* mRNA leader.

Repression of *relA* and activation of *dksA* expression by CsrA. To determine whether CsrA regulates *relA* expression, β -galactosidase specific activity from a chromosomal *relA*'-'*lacZ* translational fusion containing the upstream non-coding region through the first three codons was monitored in wild-type and *csrA* mutant strains. Disruption of *csrA* increased expression ~40%, and activity was restored to wild-type levels by complementation when *csrA* was expressed from its native promoter on a low-copy number plasmid (Fig. 2-2A). The promoters driving *relA* expression have been previously mapped (Metzger *et al.*, 1988, Nakagawa *et al.*, 2006), so to further examine CsrA-mediated repression of *relA*, expression from a transcriptional fusion containing the entire upstream non-coding region through the upstream transcriptional start was tested and found to be unaltered by the *csrA* mutation (Fig. 2-2B). In addition, the 5' untranslated region and first three codons of *relA* were cloned downstream from the

constitutive *lacUV5* promoter and in frame with '*lacZ* and integrated into the chromosome. We refer to this and other reporter fusions driven by the *lacUV5* promoter as post-transcriptional or leader fusions (Materials and Methods). Expression from the *relA* leader fusion was increased in the stationary phase in the *csrA* mutant compared to the wild-type strain (Fig. 2-2C). These data imply that CsrA affects *relA* expression post-transcriptionally and that the 5' untranslated region of the *relA* gene mediates this regulation.

In contrast, CsrA had little to no effect on the expression of a *PlacUV5-rpoZ-spoT*'-'*lacZ* leader fusion (Fig. 2-2D). Translational fusions for *gmk*, *rpoZ* or *spoT* containing the native promoters and ribosome binding sites produced extremely low levels of β -galactosidase and were not quantitated.

Expression of the *dksA*'-'*lacZ* fusion was decreased ~30% in the *csrA* mutant and was complemented by ectopic expression of *csrA* (Fig. 2-2E), indicating that CsrA activates *dksA* expression. This effect is examined in more detail below.

Effect of CsrA on *relA*, *spoT* and *dksA* steady-state transcript levels. Because CsrA frequently affects the stability and steady-state levels of its target RNAs (Liu *et al.*, 1995, Wei *et al.*, 2001, Wang *et al.*, 2005), quantitative real-time reverse transcription polymerase chain reactions (RT-qRT-PCR) on *relA*, *spoT* and *dksA* transcripts were performed with Taqman probes, using 16S rRNA as an internal control. In the *csrA* mutant, *relA* mRNA was increased 1.4-fold in exponential phase ($OD_{600} = \sim 0.5$), and 2.0-fold in stationary phase (Fig. 2-3), confirming that repression of *relA* involves an alteration in mRNA levels. In contrast to the leader fusion results, steady-state transcript levels of *spoT* RNA were increased 1.5-fold in exponential phase and 1.8-fold in

stationary phase in the *csrA* mutant (Fig. 2-3), suggesting that CsrA has an indirect effect on *spoT* transcript levels. *dksA* transcript levels remained unchanged between the *csrA* mutant and wild type strains (Fig. 2-3).

RelA accumulates in a *csrA* mutant while GMK and DksA remain unchanged. The effects of CsrA on steady state levels of RelA, GMK and DksA proteins were examined by western blotting. RelA was increased by the *csrA* mutation in both mid-exponential and stationary phases (Fig 4A), confirming the results obtained with the translational and leader reporter fusions. Steady-state protein levels of GMK, the product of the first gene of the *spo* operon (Fig. 2-1A), were unchanged in the *csrA* mutant, indicating that CsrA has no effect on *gmk* expression (Fig. 2-4B). Similar to *dksA* transcript levels, DksA protein levels were comparable between wild-type and *csrA* mutant strains (Fig. 2-4C). A possible explanation for this result is that while CsrA directly binds *dksA* mRNA and activates *dksA* expression, another factor(s) may compensate for these effects. Analyses of SpoT protein levels had technical complications.

Because CsrA bound specifically to the *relA* mRNA leader, repressed *relA* expression post-transcriptionally, and appeared to indirectly repress *spoT* expression, we examined ppGpp synthesis and accumulation in *csrA* mutant and wild-type strains using thin-layer chromatography. There was no significant difference in basal or serine hydroxamate-induced ppGpp levels in *csrA* mutant and wild-type strains (Appendix, Fig. 1). We suspect that the relatively modest stringent response that was triggered by serine hydroxamate in EZ Rich Defined Medium was insufficient to fully utilize the excess RelA protein present in the *csrA* mutant. However, growth defects of the *csrA* mutant in

minimal media prevented us from testing ppGpp levels under minimal media conditions, which would likely induce a more robust stringent response.

DksA negatively regulates its own transcription. Because CsrA bound specifically to *dksA* mRNA and a *dksA*'-'*lacZ* fusion responded modestly to CsrA, yet *dksA* transcript and protein levels were similar in the *csrA* mutant and wild-type strains, we sought to clarify the influence of CsrA on *dksA* expression. We reasoned that many global regulators are autoregulatory (H. Yakhnin and P. Babitzke, unpublished data), which might have complicated these analyses. We examined expression of a *dksA*'-'*lacZ* translational fusion and observed a ~2.5-fold increase in β -galactosidase activity in a *dksA* mutant, suggesting that DksA negatively regulates its own expression (Fig. 2-5A). β -galactosidase activity from the *dksA*'-'*lacZ* fusion was reduced to wild-type levels when *dksA* was ectopically expressed from an IPTG-inducible promoter and was further reduced upon addition of IPTG (Fig. 2-5A).

To determine if DksA negative autoregulation influences the effect of CsrA on *dksA* expression, activity of the *dksA*'-'*lacZ* translational fusion was compared in isogenic wild-type, *dksA*, *csrA* and *dksA csrA* strains. The *dksA csrA* double mutant showed ~50% less β -galactosidase activity compared to the *dksA* single mutant (Fig. 2-5B), confirming that CsrA activates DksA expression and indicating that this effect can be masked by DksA autoregulation. The *dksA csrA* double mutant exhibited an increase in β -galactosidase activity compared to the *csrA* single mutant (Fig. 2-5B), indicating that DksA negative autoregulation occurs independently of CsrA regulation.

To assess the levels at which DksA and CsrA regulate *dksA* expression, a *dksA-lacZ* transcriptional fusion and a *PlacUV5-dksA*'-'*lacZ* leader fusion were examined.

Expression from the transcriptional fusion was increased ~2.5-fold in the *dksA* mutant, similar to the translational fusion (compare Fig. 2-5C and 2-5B), revealing that negative autoregulation is mediated at the level of transcription and that the promoter DNA in this construct is sufficient for this regulation. Expression from this fusion in the *dksA* mutant was complemented by ectopic expression of *dksA* from an IPTG-inducible promoter (Appendix, Fig. 2A). In contrast, there was no significant difference in expression of the *dksA-lacZ* transcriptional fusion between the *csrA* mutant and wild-type strains or the *dksA* and *dksA csrA* double mutant strains, suggesting that CsrA regulates *dksA* post-transcriptionally (Fig. 2-5C). Furthermore, we observed a slight decrease in β -galactosidase activity from the *PlacUV5-dksA'*-*lacZ* leader fusion in the *dksA* mutant (Fig. 2-5D), demonstrating that the 5' leader of *dksA* mRNA does not support negative autoregulation, and confirming that DksA autoregulation is mediated at the level of transcription. Similar to expression of the translational fusion, β -galactosidase activity from the *PlacUV5-dksA'*-*lacZ* was decreased ~50% in a *csrA* mutant, confirming that CsrA activates *dksA* post-transcriptionally via the 5' leader of *dksA*, and that CsrA regulation occurs independently of DksA negative autoregulation (Fig. 2-5D). As expected from these findings, ectopic expression of *dksA* did not substantially alter expression from the *PlacUV5-dksA'*-*lacZ* leader fusion (Appendix, Fig. 2B).

Primer extension analysis of *dksA* mRNA was conducted to further examine DksA negative autoregulation. Transcription of *dksA* from the chromosome was below the level of detection in our hands, even after long exposures (Fig. 2-6B, Lanes 1, 4-5). Using a *dksA* mutant, we examined ectopic expression of *dksA* transcripts from strains containing plasmids that expressed either the wild-type *dksA* allele or a *dksA* allele that

contained amino acid substitutions in the two aspartic acid residues (D71N D74N) that are critical for DksA activity (Perederina *et al.*, 2004). Both alleles were expressed from the native *dksA* promoters present in these plasmids. The wild-type *dksA* allele produced two transcripts, P1 and P2, in low abundance (Fig. 2-6B, Lane 3), which were increased in the strain expressing the defective *dksA* D71N D74N allele (Fig. 2-6B, Lane 2). This finding confirmed that a functional DksA protein is required for negative autoregulation and that the P1 and P2 transcripts are both subject to this regulation. The P1 promoter has been characterized previously (Kang and Craig, 1990), and in vitro transcription analysis resulted in two identically mapped transcripts (data not shown).

To confirm that DksA directly repressed transcription from the putative P1 and P2 promoters, we attempted in vitro transcription using a linear template and purified DksA and/or ppGpp, but were unable to demonstrate DksA-mediated inhibition (data not shown), suggesting that an additional factor may be required or that this effect is indirect.

DksA and ppGpp modestly activate *csrA* expression. The Csr and stringent response systems share a number of regulatory targets, e.g. *glgCAP* (Romeo and Preiss, 1989; Romeo *et al.*, 1990; Liu and Romeo, 1997) and *flhDC* (Wei *et al.*, 2001, Lemke *et al.*, 2009). Furthermore, the Csr system possesses multiple feedback loops in which its components both control and are controlled by other factors. Thus, we reasoned that the stringent response components might regulate expression of the genes of the Csr system. Western blot analysis demonstrated that CsrA protein levels were reduced ~50% in *dksA* mutant and ppGpp⁰ strains, and CsrA protein levels in the *dksA* mutant were restored to wild-type or higher levels by ectopic expression of *dksA* (Fig. 2-7A), suggesting that DksA and ppGpp activate *csrA* expression. β -galactosidase activity from a *csrA*'-*lacZ*

translational fusion was reduced in the *dksA* and *relA spoT* (ppGpp⁰) mutants (Fig. 2-7B). Activity was restored to wild-type levels when *dksA* was expressed ectopically from an IPTG-inducible plasmid in the *dksA* mutant, and activity was further increased by the addition of IPTG (Fig. 2-7B).

We recently found that *csrA* transcription is directly activated by RpoS (σ^S), the stationary phase and general stress response sigma factor (H. Yakhnin and P. Babitzke, unpublished data). Furthermore, ppGpp and DksA are required for full expression of RpoS (Brown *et al.*, 2002, Hirsch and Elliott, 2002). We therefore asked whether DksA activation of *csrA* expression requires RpoS. Expression of the *csrA*'-*lacZ* fusion was reduced ~60% in the *rpoS* and *dksA* single mutant strains, while the *rpoS dksA* double mutant exhibited a further reduction in β -galactosidase activity (Fig. 2-7C). Ectopic expression of *dksA* from an IPTG-inducible plasmid partially restored β -galactosidase activity in the double mutant, but not to wild-type levels, suggesting that activation of *csrA* expression by DksA depends in part on RpoS.

Transcription of *csrA* is driven by at least three promoters (H. Yakhnin and P. Babitzke, unpublished data). RpoS directs *csrA* transcription from P3, while P1 and P5 are transcribed by the housekeeping sigma factor, σ^{70} . Using transcriptional *lacZ* fusions for each promoter, we found that β -galactosidase activity from the P1-*csrA-lacZ* and P5-*csrA-lacZ* fusions were unaffected by the *dksA* mutant, whereas there was a threefold reduction in activity from the P3-*csrA-lacZ* fusion in the *dksA* mutant (Fig. 2-7D-F). These data further indicate that DksA activates *csrA* expression primarily through RpoS-driven transcription of P3. Interestingly, ppGpp was required for full activity of the P1-

csrA-lacZ and P3-*csrA-lacZ* fusions (Fig. 2-7D-F), suggesting that ppGpp likely influences *csrA* expression through RpoS as well as through an additional pathway.

DksA and ppGpp activate *csrB* and *csrC* expression. To further examine effects of DksA and ppGpp on the Csr system, steady-state CsrB and CsrC RNA levels were determined by Northern blotting. Both RNAs were reduced 10-fold in *dksA* and ppGpp⁰ mutant strains (Fig. 2-8A). Additionally, *csrB* and *csrC* transcript levels were reduced in the *csrA* mutant, as previously determined (Fig. 2-8A, Suzuki *et al.*, 2002, Weilbacher *et al.*, 2003). To further characterize this regulation, we measured β -galactosidase activity from *csrB-lacZ* and *csrC-lacZ* transcriptional fusions. Activity from both fusions was decreased substantially in the *dksA* mutant and ppGpp⁰ strains (Fig. 2-8B, C), indicating that DksA and ppGpp activate *csrB* and *csrC* transcription. Furthermore, activity was restored to near wild-type levels in the *dksA* mutant strain by complementation of *dksA* using an IPTG-inducible plasmid, and activity was increased further by the addition of IPTG (Fig. 2-8B, C).

CsrA indirectly activates expression of CsrB and CsrC sRNAs, through the BarA-UvrY TCS, which directly activates their transcription (Suzuki *et al.*, 2002, Weilbacher *et al.*, 2003). BarA is a membrane bound tripartite sensor kinase, while UvrY functions as its cognate response regulator (Pernestig *et al.*, 2001). Epistasis studies were conducted to determine whether the effects of DksA on *csrB* and *csrC* expression were dependent upon UvrY. Ectopic expression of *uvrY* from a multicopy plasmid restored *csrB-lacZ* and *csrC-lacZ* expression in a *dksA uvrY* double mutant while ectopic expression of *dksA* did not, implying that *dksA* lies upstream of *uvrY* in this signaling pathway (Fig. 2-8D, E). Expression from a *uvrY'-lacZ* translational fusion was unaffected in the *dksA* mutant

strain (Appendix, Fig. 3), suggesting that DksA affects UvrY activity, not *uvrY* expression. CsrA is required for normal signaling through the BarA-UvrY TCS (Suzuki *et al.*, 2002), and since DksA activates CsrA, epistasis studies were performed to determine if DksA activated *csrB* and *csrC* expression through CsrA. In this case, neither overexpression of CsrA nor DksA fully restored *csrB-lacZ* or *csrC-lacZ* expression in a *dksA csrA* double mutant (Fig. 2-8F, G). These findings reveal that both CsrA and DksA are necessary for full expression of *csrB* and *csrC*, and suggest that their effects are not mediated in series (i.e. sequentially).

DksA, ppGpp and CsrA effects on acetate production. Because acetate acts as a stimulus for BarA-UvrY signaling, we asked whether CsrA, DksA or ppGpp might affect *csrB* and *csrC* expression via effects on acetate accumulation under our growth conditions (LB). Acetate levels were monitored through the growth curve in isogenic wild-type, *csrA*, *dksA*, *csrA dksA*, and ppGpp⁰ strains. We observed no significant difference in acetate levels in any of these strains (Appendix, Fig. 4A), suggesting that under these conditions, ppGpp, DksA and CsrA signaling may affect *barA* expression or UvrY activity through an unknown factor. Because CsrA activates glycolysis (Sabnis *et al.*, 1995), acetate accumulation was also monitored in a medium requiring glycolytic metabolism for growth (Kornberg medium; Appendix, Fig. 4B). These studies revealed that the *csrA*, *dksA* and ppGpp⁰ mutants accumulated less acetate than the parent strain. However, the effects were apparently insufficient to account for strong regulation of *csrB* and *csrC* expression by these genes. A *barA*'-*lacZ* translational fusion was constructed to monitor effects of ppGpp, DksA and CsrA on *barA* expression, but expression from this fusion was too low to permit quantitation.

DISCUSSION

The motivation for these studies was our observation that the mRNAs for the three stringent response genes, *relA*, *spoT* and *dksA*, copurified with a recombinant CsrA protein. While the Csr and stringent response systems were known to govern a number of the same genes and processes, the present study revealed novel regulatory interactions within and among the components of these global regulatory systems (summarized in Fig. 2-9). As discussed below, we propose that these interactions provide a fine-tuning role for the Csr system during stringent response, and more importantly, they downregulate CsrA activity upon induction of the stringent response. Thus, the direct transcriptional effects of stringent response, mediated by DksA and ppGpp, on a subset of its target genes are reinforced by indirect effects on their translation and/or mRNA stability via the Csr system.

Despite its strong binding interactions with *relA* and *dksA* transcripts (Fig. 2-1B-E), the effects of CsrA on *relA* and *dksA* expression were modest (Figs. 2-2 through 2-5). These results differ from the much stronger effects of CsrA on various structural genes, e.g. for glycogen and poly- β -1,6-*N*-acetyl-glucosamine biosynthesis, which are mediated via CsrA binding affinities that are similar to *relA* mRNA (Romeo *et al.*, 1993, Baker *et al.*, 2002, Wang *et al.*, 2005). Such high affinity binding in the context of modest regulation is indicative of a fine-tuning role for CsrA in stringent response. We envision a role for the Csr system in enhancing stringent response under conditions that require strong regulation, triggered by an abundance of uncharged tRNAs. Activation of *csrB* and *csrC* transcription (Fig. 2-8) under this condition should greatly increase CsrB and CsrC RNA levels, thus relieving CsrA repression of *relA*. The additional RelA protein

that accumulates through these effects should poise the cell for an enhanced response to abundant uncharged tRNAs.

In contrast to the modest to negligible effects of CsrA on stringent response components, ppGpp and DksA exhibited robust regulation (10-fold) of CsrB and CsrC levels via the response regulator UvrY (Fig. 2-8). Because DksA and ppGpp modestly activated *csrA* expression (Fig. 2-7), the net effect of increased ppGpp accumulation through the induction of stringent response should be to inhibit CsrA activity.

Furthermore, one molecule of CsrB or CsrC RNA is capable of sequestering ~10 or 5 CsrA dimers, respectively (Babitzke and Romeo, 2007), thus magnifying the indirect inhibitory effects of ppGpp on CsrA activity. The implication of these findings is that the regulation of genes that respond oppositely to CsrA versus ppGpp should be enhanced indirectly by decreased CsrA activity due to elevated CsrB and CsrC levels during stringent response. Previous studies demonstrated that CsrB and CsrC RNA levels are greatly elevated in minimal media and decline drastically upon amino acid supplementation, while CsrA exhibited only modest effects under these conditions (Jonas and Melefors, 2009b). These physiological observations are fully consistent with our genetic findings on the effects of ppGpp and DksA on CsrA, CsrB, and CsrC levels, and strengthen this model for the workings of this composite network.

Clearly, there is substantial regulatory overlap by the stringent response and Csr global regulatory systems. Altogether, 40% of the genes whose transcripts copurified with CsrA (Table 2-1) were found previously to respond to ppGpp and/or DksA (Aberg *et al.*, 2009). Even more striking, 68% of the genes of COG C, energy production and conversion, were found in to be common in these two studies (Table 2-1). These values

represent minimum estimates of the overlap, as only exact gene matches in the two data sets were tabulated.

To illustrate our model with specific examples, glycogen synthesis and *glgCAP* expression are directly activated by ppGpp (Romeo and Preiss, 1989, Romeo *et al.*, 1990) and directly repressed by CsrA (Romeo *et al.*, 1993, Baker *et al.*, 2002). During stringent response, increased CsrB and CsrC levels should relieve CsrA repression, reinforcing the direct effects of ppGpp on *glgCAP* expression. Indeed, CsrA also represses *cstA* translation (Dubey *et al.*, 2003), which is a carbon starvation response gene, required for efficient peptide uptake (Schultz and Matin, 1991). Thus, derepression of CsrA-mediated *cstA* translation during stringent response may facilitate nutrient scavenging. Furthermore, many mRNAs of amino acid and peptide uptake and metabolism genes copurified with CsrA (Table 2-1; Appendix, Table 1), raising the possibility that CsrA plays global regulatory role in peptide and amino acid uptake.

In a similar fashion, expression of *flhDC*, which encodes the master regulator of the motility cascade, is transcriptionally repressed by DksA and ppGpp (Lemke *et al.*, 2009) and activated post-transcriptionally by CsrA binding to and stabilizing *flhDC* mRNA (Wei *et al.*, 2001). In this case, the indirect effects of stringent response on the Csr system should reinforce its direct negative effects on motility by decreasing CsrA activity. Thus, Csr and ppGpp are proposed to function together under starvation conditions to promote nutrient acquisition and sequestration of intracellular carbon and energy, while repressing energy intensive flagellum synthesis and motility, under starvation conditions.

The effects of DksA and ppGpp on expression and levels of CsrB and CsrC RNAs required CsrA and the response regulator UvrY (Fig. 2-8), which directly stimulates *csrB* and *csrC* transcription (Suzuki *et al.*, 2002, Weilbacher *et al.*, 2003). Because DksA and ppGpp did not affect *uvrY* expression (Appendix, Fig. 3), and ectopic expression of *uvrY* restored *csrB* and *csrC* expression in a *dksA uvrY* mutant background, it is apparent that DksA somehow affects UvrY activity. In *Pseudomonas aeruginosa*, the BarA sensor-kinase ortholog (GacS), as well as two other sensors that do not have orthologs in *E. coli*, RetS (Goodman *et al.*, 2004, Goodman *et al.*, 2009) and LadS (Ventre *et al.*, 2006), regulate the activity of the UvrY ortholog (GacA). Whether BarA alone or other regulatory factors in *E. coli* mediate DksA and ppGpp effects on *csrB* and *csrC* expression will require additional investigation.

Previous studies revealed that DksA protein levels remain relatively constant throughout growth (Brown *et al.*, 2002, Paul *et al.*, 2004a, Rutherford *et al.*, 2007). A recent stringent response model suggests that since DksA levels are constant, ppGpp levels mediate stringent control upon nutritional stress (Dalebroux *et al.*, 2010). Our results further demonstrated that DksA levels are regulated by a negative feedback loop, whereby DksA represses its own transcription. Autoregulation of *dksA* tended to mask the opposing effect of CsrA (Fig. 2-5). Such an effect is consistent with negative feedback loops in promoting homeostasis (Becskei and Serrano, 2000), and is not unexpected for a gene whose product is maintained within a relatively narrow range.

We previously demonstrated that the Csr system of *E. coli* contains multiple negative feedback loops (Suzuki *et al.*, 2002, Weilbacher *et al.*, 2003, Suzuki *et al.*, 2006, Fig. 2-9), which may provide distinct advantages for this regulatory network. Negative

feedback loops produce graded responses, thus reducing cell-cell variability (Nevozhay *et al.*, 2009) and stochastic events and noise (Becskei and Serrano, 2000), and can also accelerate regulatory responses (Rosenfeld *et al.*, 2002). The critical negative feedback loop of the Csr system involves a multistep pathway from CsrA to *csrB* and *csrC* expression via the BarA-UvrY TCS (Fig. 2-9). The recent finding that acetate is a stimulus for BarA signaling (Chavez *et al.*, 2010), coupled with previous studies showing that CsrA activates glycolysis (Sabnis *et al.*, 1995), suggested that glycolysis might provide the link between CsrA and BarA activity. However, we determined here that mutations affecting CsrA, DksA or ppGpp have negligible or modest effects on acetate accumulation under gluconeogenic or glycolytic growth conditions, respectively (Appendix, Fig. 4). Thus, effects of these genes on acetate accumulation cannot account for their impact on *csrB* and *csrC* expression, and additional studies will be necessary to define this negative feedback loop, which provides a central link between the Csr and stringent response systems.

A surprising observation was that CsrA had opposite effects on *relA* and *dksA* expression (e.g. Fig. 2-2). Although ppGpp and DksA often potentiate each other's effects, there have been several reports of independent and even antagonistic effects of ppGpp and DksA (Magnusson *et al.*, 2007, Aberg *et al.*, 2008, Aberg *et al.*, 2009, Lyzen *et al.*, 2009, Merrikh *et al.*, 2009). Indeed, ppGpp⁰ and *dksA* mutant strains exhibit multiple, but not identical, amino acid auxotrophies (Brown *et al.*, 2002, Potrykus *et al.*, 2010b), perhaps signifying alternative gene expression roles for ppGpp and DksA. Presently, it is not clear how the modest effect of CsrA on *dksA* expression impacts such

differential genetic regulation or whether negative feedback by DksA itself overshadows CsrA effects under all physiological conditions.

Given that stringent response was only one of many transcriptional regulatory systems whose mRNAs copurified with CsrA (Table 2-1, Appendix, Table 1), the complexity of the regulatory circuitry surrounding the Csr system is undoubtedly vast. Supporting this hypothesis, transcripts for regulatory factors necessary for critical cellular processes were identified, including alternative sigma factors (*rpoE* and *rpoH*), universal stress proteins (*uspA*, *uspB* and *uspD*) and the proteins that mediate catabolite repression (*crp* and *cyaA*). A recent study reveals additional complexity within the Csr system, consisting of direct feedback repression by CsrA of its own translation and indirect activation of its transcription via RpoS (H. Yakhnin and P. Babitzke, unpublished data). We expect that the high-throughput sequencing of CsrA-bound transcripts from the present study will spur additional research on the complex circuitry and global regulatory role of Csr system.

MATERIALS AND METHODS

Bacterial strains, phage, plasmids and growth conditions. All *E. coli* K-12 strains, plasmids and bacteriophage used in this study are listed in Appendix, Table 4. Unless otherwise indicated, bacteria were grown at 37°C, shaking at 250 rpm, in Luria-Bertani (LB) medium (Miller, 1972). Media were supplemented with antibiotics, as needed, at the following concentrations: kanamycin, 100 µg/ml; ampicillin, 25 µg/ml; spectinomycin, 25 µg/ml; chloramphenicol, 25 µg/ml; and tetracycline, 10 µg/ml, except

that ampicillin was used at 100 µg/ml during the construction of *lacZ* fusion plasmids. P1*vir* transduction was performed as previously described (Miller, 1972).

Construction of transcriptional, translational and leader fusions and integration into the chromosome. Plasmids pRELZ and pDKSZ were constructed by PCR amplification of an 888 bp fragment containing the upstream regulatory region through the first three codons of *relA* and 628 bp fragment containing the upstream regulatory region through the first three codons of *dksA* using the primer pairs relA-F/relA-R and dksA-F/dksA-R. Table S5 lists primer sequences. The products were digested with *EcoRI* and *BamHI* and cloned into the same sites of pMLB1034 to create *relA*'-'*lacZ* and *dksA*'-'*lacZ* translational fusions. Both fusions were moved into the *E. coli* CF7789 chromosome using λInCh1 and confirmed by PCR analysis, as previously described (Boyd *et al.*, 2000).

A series of plasmids using the pAH125 plasmid backbone (Haldimann and Wanner, 2001) were created for the generation of various *lacZ* fusions. pLFT was generated to replace the kanamycin resistance marker of pAH125 with ampicillin resistance. The *bla* PCR product was generated using the primer pair AmpRF/AmpRR and plasmid pUC19 DNA as template. Purified PCR product was digested with *ClaI* and *NotI*. *ClaI/NotI* digestion of pAH125 generated three fragments; the 1.2 kb and 3.5 kb DNA fragments were purified from 1X TAE agarose gels and ligated with the *bla* PCR product to generate the *lacZ* transcriptional fusion vector, pLFX. pLFX was used to generate a *lacZ* translational fusion vector. *BssHII/EcoRI* digestion of pLFX and pMLB1034 liberated 4.3 kb and 1.5 kb fragments, respectively. These fragments were gel purified and ligated to generate the *lacZ* translation fusion vector, pLFT. pLFT was also

used to create a post-transcriptional (or leader) fusion vector containing the constitutive *lacUV5* promoter. The *lacUV5* promoter was amplified using the primer pair LPF-19/LPF-20 and pUV5moaA (L. Patterson-Fortin and T. Romeo, unpublished data) plasmid DNA as template, and the purified PCR product was digested with *Pst*I and *Eco*RI and cloned into *Pst*I/*Eco*RI digested pLFT plasmid DNA. The resulting plasmid pUV5 allows construction of *lacZ* translational fusions expressed from the constitutive *lacUV5* promoter.

Plasmid pPFINT was constructed to replace the ampicillin resistance marker of the parent plasmid, pINT-ts (Haldimann and Wanner, 2001), with tetracycline resistance. The *tet* PCR product was generated using the primer pair LPF-21/LPF-22 and pBR322 plasmid DNA as template, and the purified PCR product was digested with *Cla*I. pINT-ts was digested with *Bgl*II, blunt-ended using DNA polymerase I, and digested with *Cla*I. The resulting 4 kb fragment was gel purified and ligated with the *Cla*I-digested *tet* PCR product to generate pPFINT.

The plasmids pRELZtxn and pDKSZtxn were constructed by PCR amplification of a 255 bp fragment containing the upstream regulatory region of *relA* from -880 to -625 relative to the translational start and a 66 bp fragment containing the upstream regulatory region of *dksA* from -118 to -52 relative to the translational start using the primer pairs *relA*-F-txn/*relA*-R-txn and *dksA*-F-txn/*dksA*-R-txn, respectively. The products were digested with *Pst*I and *Bam*HI and cloned into the same sites of pLFX to create *relA-lacZ* and *dksA-lacZ* transcriptional fusions. Plasmids pRELZplac, pDKSZplac, pGMKZplac, and pSPOZplac were constructed by PCR amplification of the 5' untranslated mRNA leaders of *relA*, *dksA*, *gmk*, and *rpoZ-spoT* using the primer pairs

relA-F-plac/relA-R, dksA-F-plac/dksA-R, gmk-F-plac/gmk-R-plac, and spoT-F-plac/spoT-R-plac, respectively, to create leader fusions under the control of the *lacUV5* promoter. These products were digested with *EcoRI* and *BamHI* and cloned into the same sites of pUV5. All fusions were integrated into the CF7789 chromosome as previously described (Haldimann and Wanner, 2001). All oligonucleotide primers used in this study (Table 5) were synthesized by Integrated DNA Technologies Inc., Coralville, Iowa, and all cloned DNA inserts were sequenced to confirm the absence of mutations.

Cloning of the *csrA* gene. The plasmid pCsrA, encoding the *csrA* gene including 400 bp upstream from the start of *csrA* translation through the coding region, was constructed by PCR amplifying the *csrA* gene with primers csrA-F-pGB2 and csrA-R-pGB2. The PCR product was digested with *HindIII* and *EcoRI* and cloned into the same sites of pGB2 (Churchward *et al.*, 1984).

RNA Electrophoretic Mobility Shift Assays. Quantitative gel mobility shift assays followed a previously published procedure (Yakhnin *et al.*, 2000). *E. coli* CsrA-His₆ protein was purified as described previously (Mercante *et al.*, 2006). DNA templates for *relA* and *gmk* transcript were PCR-amplified from MG1655 genomic DNA using the primer pairs relA-F-T7/relA-R-T7 and gmk-F-T7/gmk-R-T7. DNA templates for *rpoZ* and all *dksA* transcripts were produced by annealing primer pairs rpoZ-T7/GC-rpoZ-T7, dksA-T7/GC-dksA-T7, dksA-BS1/GC-dksA-BS1, dksA-BS2/GC-dksA-BS2, and dksA-BS1-2/GC-dksA-BS1-2. RNA was synthesized *in vitro* using the MEGAshortscript kit (Ambion, Austin, TX) and purified PCR products (for *relA* and *rpoZ*), annealed DNA primers (*gmk* and all *dksA* transcripts) or linearized plasmid pPB77 (for nonspecific *trp*

leader RNA from *B. subtilis*) (Babitzke *et al.*, 1994) as templates, and RNA was gel purified. Transcripts were 5' end-labeled using T4 polynucleotide kinase and [γ - 32 P]-ATP. Radiolabeled RNA was gel purified and resuspended in TE (10 mM Tris-HCl pH 8.0, 1 mM EDTA), heated to 85°C and chilled on ice. Increasing concentrations of purified CsrA-His₆ recombinant protein were combined with 80 pM radiolabeled RNA in 10 μ l binding reactions [10 mM Tris-HCl pH 7.5, 10 mM MgCl₂, 100 mM KCl, 3.25 ng total yeast RNA, 20 mM DTT, 7.5% glycerol, 4 U SUPERasin (Ambion, Austin, TX)] for 30 min at 37°C to allow for CsrA–RNA complex formation. Competition assays were performed in the absence or presence of unlabelled RNA specific and non-specific competitors. Binding reactions were separated using 10% native TBE polyacrylamide gels, and radioactive bands were visualized with a Molecular Dynamics phosphorimager. Free and bound RNA species were quantified with Quantity One (Bio-Rad, Hercules, CA), and an apparent equilibrium binding constant (κ_d) was calculated for CsrA–RNA complex formation according to a previously described cooperative binding equation (Mercante *et al.*, 2006).

β -galactosidase and total protein assays. β -galactosidase activity was determined as described previously (Romeo *et al.*, 1990), except that 100 μ l chloroform and 50 μ l 0.01% SDS were used for cell membrane permeabilization. Total cellular protein was measured by the bicinchoninic acid (BCA) assay with bovine serum albumin as the protein standard (Pierce Biotechnology, Rockford, IL). All analyses compared isogenic strains, derived from CF7789.

rt-qRT-PCR. To measure steady-state levels of *relA*, *spoT* and *dksA* transcripts, wild-type (MG1655) and *csrA* mutant strains were grown at 37°C in LB medium, and

cells were harvested in exponential ($OD_{600} \approx 0.5$) and early stationary phases. Total RNA was isolated using the Ribo-pure Bacteria Kit (Ambion, Austin, TX) according to the manufacturer's instructions. RNA was quantified by its absorbance at 260 and 280 nm, and rRNA integrity was analyzed on formaldehyde agarose gels. Real-time quantitative reverse-transcription PCR (rt-qRT-PCR) was performed using the iScript one-step RT-PCR Kit (Bio-Rad, Hercules, CA), the primer pairs *relA*-F-taqman and *relA*-R-taqman, *spoT*-F-taqman and *spoT*-R-taqman, and *dksA*-F-taqman and *dksA*-R-taqman and the probes *relA*-6FAM-BHQ1, *spoT*-6FAM-BHQ1, and *dksA*-6FAM-BHQ1, which were 5'-end labeled with 6-carboxyfluorescein (6FAM) and 3'-end labeled with Black Hole Quencher 1(BHQ1). Reactions were conducted using the Lightcycler 480 (Roche Diagnostics) under the following conditions: 50°C for 10 min, 95°C for 5 min, and 40 cycles of 95°C for 15 sec and 60°C for 30 seconds with real time measurements taken at the 60°C step. Each reaction was performed in triplicate in two independent experiments, each time with 100 ng and 10 ng template RNA, and the mean values of the two experiments were determined. A reaction lacking reverse transcriptase was included for each sample, which served as a control for DNA contamination. For normalization of *relA*, *spoT* and *dksA* transcript levels, rt-qRT-PCRs were performed with each sample for 16S rRNA quantitation using the primer pair 16S-Fw and 16S-Rw and the probe 16S-6FAM-BHQ1 (Baker *et al.*, 2007). The reaction conditions for rt-qRT-PCR of 16S rRNA were identical to the other transcripts except that 1 ng and 0.1 ng of RNA were used for each example. The PCR product identities were confirmed by electrophoresis on 1% agarose gels with ethidium bromide staining. The $2^{-\Delta\Delta CT}$ method was used to calculate relative transcript levels (Livak and Schmittgen, 2001).

Western blotting. Cultures for western blot analyses were grown at 37°C with shaking, and at indicated time points, cells from 1 ml of culture were concentrated and resuspended in Lysis Buffer A (90 mM Tris-HCl, 2% SDS, pH 6.8). Samples were boiled for 3 min, cell debris was removed by centrifugation, and the supernatant saved and assayed for total protein using the BCA assay with bovine serum albumin as the protein standard (Pierce Biotechnology, Rockford, IL). 10 µg total protein was applied to 8-15% SDS-polyacrylamide gels and transferred to Immunoblot PVDF membrane (Bio-Rad, Hercules, CA) after separation. RelA, DksA and CsrA proteins were detected as previously described (Brown *et al.*, 2002, Gudapaty *et al.*, 2001). GMK antibody was obtained from the Cashel lab and was raised against GMK protein purified as previously described (Gentry *et al.*, 1993). Protein bands were quantified with Quantity One (Bio-Rad, Hercules, CA).

Primer Extension. Primer extension was carried out as previously described (Potrykus *et al.*, 2010a) except that 10 µg of total RNA was used. RNA was isolated from the following strains: CF9239 (MG1655 *dksA::kan*), CF9239/pJK537 and CF9239/pHM1684.

Northern Blotting. Bacterial cells were grown in LB at 37°C with shaking, and cellular RNA was stabilized by the addition of 2 vol of the RNeasy Protect Bacteria Reagent (Qiagen). Total cellular RNA was extracted using the RNeasy Mini kit (Qiagen) and the resulting RNA (5 µg) was separated on 5% polyacrylamide gels containing 7 M urea, and transferred to positively charged nylon membranes (Roche Diagnostics) by electroblotting using the Mini Trans-Blot Cell (Bio-Rad, Hercules, CA) according to the manufacturer's instructions. RNA was cross-linked to nylon membranes by exposure to

UV light (120,000 μ J) followed by baking at 80° C for 30 min. Membranes were then blotted with DIG-labeled anti-sense RNA probes using the DIG Northern Starter Kit (Roche Diagnostics) according to the manufacturer's instructions. Blots were developed using the ChemiDoc XRS+ system (Bio-Rad, Hercules, CA) and densitometry was performed using Quantity One image analysis software (Bio-Rad, Hercules, CA).

ACKNOWLEDGEMENTS

This work was supported by National Institutes of Health grant GM059969 (T.R. and P.B.); FLA-MCS-004949 from University of Florida CRIS project (T.R.); by grants AI084160 and AI058284 (S.A.T.); by grants IN219709-3 from DGAPA-PAPIIT of UNAM and CRP/MEX08-02 from the International Centre for Genetic Engineering and Biotechnology (ICGEB) (D.G.); and in part by the Eunice Kennedy Shriver National Institute of Child Health and Human Development intramural program of the National Institutes of Health (M.C.). We gratefully acknowledge the original contributions and findings by Daniel Vinella to the DksA autoregulation studies. We also thank Helen Murphy for pHM1684. We would like to express our gratitude to William Farmerie at the University of Florida ICBR for 454 Sequencing of CsrA-bound RNA.

REFERENCES

- Aberg, A., J. Fernandez-Vazquez, J. D. Cabrer-Panes, A. Sanchez and C. Balsalobre. (2009) Similar and divergent effects of ppGpp and DksA deficiencies on transcription in *Escherichia coli*. *J Bacteriol* **191**: 3226-3236.

- Aberg, A., V. Shingler and C. Balsalobre. (2008) Regulation of the *fimB* promoter: a case of differential regulation by ppGpp and DksA in vivo. *Mol Microbiol* **67**: 1223-1241.
- Babitzke, P. and T. Romeo, (2007) CsrB sRNA family: sequestration of RNA-binding regulatory proteins. *Curr Opin Microbiol* **10**: 156-163.
- Babitzke, P., J. T. Stults, S. J. Shire and C. Yanofsky. (1994) TRAP, the *trp* RNA-binding attenuation protein of *Bacillus subtilis*, is a multisubunit complex that appears to recognize G/UAG repeats in the *trpEDCFBA* and *trpG* transcripts. *J Biol Chem* **269**: 16597-16604.
- Baker, C. S., L. A. Eory, H. Yakhnin, J. Mercante, T. Romeo and P. Babitzke. (2007) CsrA inhibits translation initiation of *Escherichia coli* *hfq* by binding to a single site overlapping the Shine-Dalgarno sequence. *J Bacteriol* **189**: 5472-5481.
- Baker, C. S., I. Morozov, K. Suzuki, T. Romeo and P. Babitzke. (2002) CsrA regulates glycogen biosynthesis by preventing translation of *glgC* in *Escherichia coli*. *Mol Microbiol* **44**: 1599-1610.
- Barker, M. M., T. Gaal, C. A. Josaitis and R. L. Gourse. (2001) Mechanism of regulation of transcription initiation by ppGpp. I. Effects of ppGpp on transcription initiation in vivo and in vitro. *J Mol Biol* **305**: 673-688.
- Becskei, A. and L. Serrano. (2000) Engineering stability in gene networks by autoregulation. *Nature* **405**: 590-593.
- Beisel, C. L. and G. Storz. (2010) Base pairing small RNAs and their roles in global regulatory networks. *FEMS Microbiol Rev.*

- Bhatt, S., A. N. Edwards, H. T. Nguyen, D. Merlin, T. Romeo and D. Kalman. (2009) The RNA binding protein CsrA is a pleiotropic regulator of the locus of enterocyte effacement pathogenicity island of enteropathogenic *Escherichia coli*. *Infect Immun* **77**: 3552-3568.
- Boyd, D., D. S. Weiss, J. C. Chen and J. Beckwith. (2000) Towards single-copy gene expression systems making gene cloning physiologically relevant: lambda InCh, a simple *Escherichia coli* plasmid-chromosome shuttle system. *J Bacteriol* **182**: 842-847.
- Brencic, A. and S. Lory. (2009) Determination of the regulon and identification of novel mRNA targets of *Pseudomonas aeruginosa* RsmA. *Mol Microbiol* **72**: 612-632.
- Brown, L., D. Gentry, T. Elliott and M. Cashel. (2002) DksA affects ppGpp induction of RpoS at a translational level. *J Bacteriol* **184**: 4455-4465.
- Burrowes, E., C. Baysse, C. Adams and F. O'Gara. (2006) Influence of the regulatory protein RsmA on cellular functions in *Pseudomonas aeruginosa* PAO1, as revealed by transcriptome analysis. *Microbiology* **152**: 405-418.
- Cashel, M. and J. Gallant. (1969) Two compounds implicated in the function of the *RC* gene of *Escherichia coli*. *Nature* **221**: 838-841.
- Cashel, M., D. Gentry, V. J. Hernandez and D. Vinella. (1996) The stringent response. In: *Escherichia coli and Salmonella: Cellular and Molecular Biology*. F. C. Neidhardt, *et al.* (ed). Washington, D.C.: ASM Press, pp. 1458-1496.
- Chavez, R. G., A. F. Alvarez, T. Romeo and D. Georgellis. (2010) The physiological stimulus for the BarA sensor kinase. *J Bacteriol* **192**: 2009-2012.

- Churchward, G., D. Belin and Y. Nagamine. (1984) A pSC101-derived plasmid which shows no sequence homology to other commonly used cloning vectors. *Gene* **31**: 165-171.
- Costanzo, A., H. Nicoloff, S. E. Barchinger, A. B. Banta, R. L. Gourse and S. E. Ades. (2008) ppGpp and DksA likely regulate the activity of the extracytoplasmic stress factor sigmaE in *Escherichia coli* by both direct and indirect mechanisms. *Mol Microbiol* **67**: 619-632.
- Cui, Y., A. Chatterjee, Y. Liu, C. K. Dumenyo and A. K. Chatterjee. (1995) Identification of a global repressor gene, *rsmA*, of *Erwinia carotovora* subsp. *carotovora* that controls extracellular enzymes, N-(3-oxohexanoyl)-L-homoserine lactone, and pathogenicity in soft-rotting *Erwinia* spp. *J Bacteriol* **177**: 5108-5115.
- Dalebroux, Z. D., S. L. Svensson, E. C. Gaynor and M. S. Swanson. (2010) ppGpp conjures bacterial virulence. *Microbiol Mol Biol Rev* **74**: 171-199.
- Dubey, A. K., C. S. Baker, T. Romeo and P. Babitzke. (2005) RNA sequence and secondary structure participate in high-affinity CsrA-RNA interaction. *RNA* **11**: 1579-1587.
- Dubey, A. K., C. S. Baker, K. Suzuki, A. D. Jones, P. Pandit, T. Romeo and P. Babitzke. (2003) CsrA regulates translation of the *Escherichia coli* carbon starvation gene, *cstA*, by blocking ribosome access to the *cstA* transcript. *J Bacteriol* **185**: 4450-4460.
- Fortune, D. R., M. Suyemoto and C. Altier. (2006) Identification of CsrC and characterization of its role in epithelial cell invasion in *Salmonella enterica* serovar Typhimurium. *Infect Immun* **74**: 331-339.

- Gentry, D., C. Bengra, K. Ikehara and M. Cashel. (1993) Guanylate kinase of *Escherichia coli* K-12. *J Biol Chem* **268**: 14316-14321.
- Gong, L., K. Takayama and S. Kjelleberg. (2002) Role of spoT-dependent ppGpp accumulation in the survival of light-exposed starved bacteria. *Microbiology* **148**: 559-570.
- Goodman, A. L., B. Kulasekara, A. Rietsch, D. Boyd, R. S. Smith and S. Lory. (2004) A signaling network reciprocally regulates genes associated with acute infection and chronic persistence in *Pseudomonas aeruginosa*. *Dev Cell* **7**: 745-754.
- Goodman, A. L., M. Merighi, M. Hyodo, I. Ventre, A. Filloux and S. Lory. (2009) Direct interaction between sensor kinase proteins mediates acute and chronic disease phenotypes in a bacterial pathogen. *Genes Dev* **23**: 249-259.
- Gottesman, S. (1984) Bacterial regulation: global regulatory networks. *Annu Rev Genet* **18**: 415-441.
- Gudapaty, S., K. Suzuki, X. Wang, P. Babitzke and T. Romeo. (2001) Regulatory interactions of Csr components: the RNA binding protein CsrA activates *csrB* transcription in *Escherichia coli*. *J Bacteriol* **183**: 6017-6027.
- Haldimann, A. and B. L. Wanner. (2001) Conditional-replication, integration, excision, and retrieval plasmid-host systems for gene structure-function studies of bacteria. *J Bacteriol* **183**: 6384-6393.
- Hirsch, M. and T. Elliott. (2002) Role of ppGpp in rpoS stationary-phase regulation in *Escherichia coli*. *J Bacteriol* **184**: 5077-5087.

- Jackson, D. W., K. Suzuki, L. Oakford, J. W. Simecka, M. E. Hart and T. Romeo. (2002) Biofilm formation and dispersal under the influence of the global regulator CsrA of *Escherichia coli*. *J Bacteriol* **184**: 290-301.
- Jonas, K., A. N. Edwards, R. Simm, T. Romeo, U. Romling and O. Melefors. (2008) The RNA binding protein CsrA controls cyclic di-GMP metabolism by directly regulating the expression of GGDEF proteins. *Mol Microbiol* **70**: 236-257.
- Jonas, K. and O. Melefors. (2009) The *Escherichia coli* CsrB and CsrC small RNAs are strongly induced during growth in nutrient-poor medium. *FEMS Microbiol Lett* **297**: 80-86.
- Kang, P. J. and E. A. Craig. (1990) Identification and characterization of a new *Escherichia coli* gene that is a dosage-dependent suppressor of a *dnaK* deletion mutation. *J Bacteriol* **172**: 2055-2064.
- Lawhon, S. D., J. G. Frye, M. Suyemoto, S. Porwollik, M. McClelland and C. Altier. (2003) Global regulation by CsrA in *Salmonella typhimurium*. *Mol Microbiol* **48**: 1633-1645.
- Lemke, J. J., T. Durfee and R. L. Gourse. (2009) DksA and ppGpp directly regulate transcription of the *Escherichia coli* flagellar cascade. *Mol Microbiol* **74**: 1368-1379.
- Lenz, D. H., M. B. Miller, J. Zhu, R. V. Kulkarni and B. L. Bassler. (2005) CsrA and three redundant small RNAs regulate quorum sensing in *Vibrio cholerae*. *Mol Microbiol* **58**: 1186-1202.
- Liu, M. Y., G. Gui, B. Wei, J. F. Preston, 3rd, L. Oakford, U. Yuksel, D. P. Giedroc and T. Romeo. (1997) The RNA molecule CsrB binds to the global regulatory protein

- CsrA and antagonizes its activity in *Escherichia coli*. *J Biol Chem* **272**: 17502-17510.
- Liu, M. Y. and T. Romeo. (1997) The global regulator CsrA of *Escherichia coli* is a specific mRNA-binding protein. *J Bacteriol* **179**: 4639-4642.
- Liu, M. Y., H. Yang and T. Romeo. (1995) The product of the pleiotropic *Escherichia coli* gene *csrA* modulates glycogen biosynthesis via effects on mRNA stability. *J Bacteriol* **177**: 2663-2672.
- Livak, K. J. and T. D. Schmittgen. (2001) Analysis of relative gene expression data using real-time quantitative PCR and the 2(-Delta Delta C(T)) Method. *Methods* **25**: 402-408.
- Lyzen, R., M. Kochanowska, G. Wegrzyn and A. Szalewska-Palasz. (2009) Transcription from bacteriophage lambda pR promoter is regulated independently and antagonistically by DksA and ppGpp. *Nucleic Acids Res* **37**: 6655-6664.
- Magnusson, L. U., B. Gummesson, P. Joksimovic, A. Farewell and T. Nystrom. (2007) Identical, independent, and opposing roles of ppGpp and DksA in *Escherichia coli*. *J Bacteriol* **189**: 5193-5202.
- Margulies, M., M. Egholm, W. E. Altman, S. Attiya, J. S. Bader, L. A. Bemben, J. Berka, M. S. Braverman, Y. J. Chen, Z. Chen, S. B. Dewell, L. Du, J. M. Fierro, X. V. Gomes, B. C. Godwin, W. He, S. Helgesen, C. H. Ho, G. P. Irzyk, S. C. Jando, M. L. Alenquer, T. P. Jarvie, K. B. Jirage, J. B. Kim, J. R. Knight, J. R. Lanza, J. H. Leamon, S. M. Lefkowitz, M. Lei, J. Li, K. L. Lohman, H. Lu, V. B. Makhijani, K. E. McDade, M. P. McKenna, E. W. Myers, E. Nickerson, J. R. Nobile, R. Plant, B. P. Puc, M. T. Ronan, G. T. Roth, G. J. Sarkis, J. F. Simons, J. W.

- Simpson, M. Srinivasan, K. R. Tartaro, A. Tomasz, K. A. Vogt, G. A. Volkmer, S. H. Wang, Y. Wang, M. P. Weiner, P. Yu, R. F. Begley and J. M. Rothberg. (2005) Genome sequencing in microfabricated high-density picolitre reactors. *Nature* **437**: 376-380.
- Mercante, J., K. Suzuki, X. Cheng, P. Babitzke and T. Romeo. (2006) Comprehensive alanine-scanning mutagenesis of *Escherichia coli* CsrA defines two subdomains of critical functional importance. *J Biol Chem* **281**: 31832-31842.
- Merrikh, H., A. E. Ferrazzoli and S. T. Lovett. (2009) Growth phase and (p)ppGpp control of IraD, a regulator of RpoS stability, in *Escherichia coli*. *J Bacteriol* **191**: 7436-7446.
- Metzger, S., I. B. Dror, E. Aizenman, G. Schreiber, M. Toone, J. D. Friesen, M. Cashel and G. Glaser. (1988) The nucleotide sequence and characterization of the *relA* gene of *Escherichia coli*. *J Biol Chem* **263**: 15699-15704.
- Miller, J. H. (1972) *Experiments in molecular genetics*, p. xvi, 466 p. Cold Spring Harbor Laboratory, Cold Spring Harbor, N.Y.
- Nakagawa, A., T. Oshima and H. Mori. (2006) Identification and characterization of a second, inducible promoter of *relA* in *Escherichia coli*. *Genes Genet Syst* **81**: 299-310.
- Nevozhay, D., R. M. Adams, K. F. Murphy, K. Josic and G. Balazsi. (2009) Negative autoregulation linearizes the dose-response and suppresses the heterogeneity of gene expression. *Proc Natl Acad Sci U S A* **106**: 5123-5128.
- Paul, B. J., M. M. Barker, W. Ross, D. A. Schneider, C. Webb, J. W. Foster and R. L. Gourse. (2004) DksA: a critical component of the transcription initiation

machinery that potentiates the regulation of rRNA promoters by ppGpp and the initiating NTP. *Cell* **118**: 311-322.

Paul, B. J., M. B. Berkmen and R. L. Gourse. (2005) DksA potentiates direct activation of amino acid promoters by ppGpp. *Proc Natl Acad Sci U S A* **102**: 7823-7828.

Perederina, A., V. Svetlov, M. N. Vassilyeva, T. H. Tahirov, S. Yokoyama, I. Artsimovitch and D. G. Vassilyev. (2004) Regulation through the secondary channel--structural framework for ppGpp-DksA synergism during transcription. *Cell* **118**: 297-309.

Pernestig, A. K., O. Melefors and D. Georgellis. (2001) Identification of UvrY as the cognate response regulator for the BarA sensor kinase in *Escherichia coli*. *J Biol Chem* **276**: 225-231.

Potrykus, K. and M. Cashel. (2008) (p)ppGpp: still magical? *Annu Rev Microbiol* **62**: 35-51.

Potrykus, K., H. Murphy, X. Chen, J. A. Epstein and M. Cashel. (2010a) Imprecise transcription termination within *Escherichia coli* *greA* leader gives rise to an array of short transcripts, GraL. *Nucleic Acids Res* **38**: 1636-1651.

Potrykus, K., H. Murphy, N. Philippe and M. Cashel, (2010b) ppGpp is the major source of growth rate control in *E. coli*. *Environ Microbiol*.

Romeo, T. and J. Preiss. (1989) Genetic regulation of glycogen biosynthesis in *Escherichia coli*: in vitro effects of cyclic AMP and guanosine 5'-diphosphate 3'-diphosphate and analysis of in vivo transcripts. *J. Bacteriol.* **171**: 2773-2782.

Romeo, T., M. Gong, M. Y. Liu and A. M. Brun-Zinkernagel. (1993) Identification and molecular characterization of *csrA*, a pleiotropic gene from *Escherichia coli* that

- affects glycogen biosynthesis, gluconeogenesis, cell size, and surface properties. *J Bacteriol* **175**: 4744-4755.
- Romeo, T., J. Black, and J. Preiss. (1990) Genetic regulation of glycogen synthesis in *Escherichia coli*: in vivo effects of the catabolite repression and stringent response systems in *glg* gene expression. *Curr. Microbiol.* **21**: 131-137.
- Rosenfeld, N., M. B. Elowitz and U. Alon. (2002) Negative autoregulation speeds the response times of transcription networks. *J Mol Biol* **323**: 785-793.
- Rutherford, S. T., J. J. Lemke, C. E. Vrentas, T. Gaal, W. Ross and R. L. Gourse. (2007) Effects of DksA, GreA, and GreB on transcription initiation: insights into the mechanisms of factors that bind in the secondary channel of RNA polymerase. *J Mol Biol* **366**: 1243-1257.
- Sabnis, N. A., H. Yang and T. Romeo. (1995) Pleiotropic regulation of central carbohydrate metabolism in *Escherichia coli* via the gene *csrA*. *J Biol Chem* **270**: 29096-29104.
- Schubert, M., K. Lapouge, O. Duss, F. C. Oberstrass, I. Jelesarov, D. Haas and F. H. Allain. (2007) Molecular basis of messenger RNA recognition by the specific bacterial repressing clamp RsmA/CsrA. *Nat Struct Mol Biol* **14**: 807-813.
- Schultz, J. E. and A. Martin. (1991) Molecular and functional characterization of a carbon starvation gene of *Escherichia coli*. *J Mol Biol* **218**: 129-140.
- Seyfzadeh, M., J. Keener and M. Nomura. (1993) *spoT*-dependent accumulation of guanosine tetraphosphate in response to fatty acid starvation in *Escherichia coli*. *Proc Natl Acad Sci U S A* **90**: 11004-11008.

- Suzuki, K., P. Babitzke, S. R. Kushner and T. Romeo. (2006) Identification of a novel regulatory protein (CsrD) that targets the global regulatory RNAs CsrB and CsrC for degradation by RNase E. *Genes Dev* **20**: 2605-2617.
- Suzuki, K., X. Wang, T. Weilbacher, A. K. Pernestig, O. Melefors, D. Georgellis, P. Babitzke and T. Romeo. (2002) Regulatory circuitry of the CsrA/CsrB and BarA/UvrY systems of *Escherichia coli*. *J Bacteriol* **184**: 5130-5140.
- Ventre, I., A. L. Goodman, I. Vallet-Gely, P. Vasseur, C. Soscia, S. Molin, S. Bleves, A. Lazdunski, S. Lory and A. Filloux. (2006) Multiple sensors control reciprocal expression of *Pseudomonas aeruginosa* regulatory RNA and virulence genes. *Proc Natl Acad Sci U S A* **103**: 171-176.
- Vinella, D., C. Albrecht, M. Cashel and R. D'Ari. (2005) Iron limitation induces SpoT-dependent accumulation of ppGpp in *Escherichia coli*. *Mol Microbiol* **56**: 958-970.
- Wang, X., A. K. Dubey, K. Suzuki, C. S. Baker, P. Babitzke and T. Romeo. (2005) CsrA post-transcriptionally represses *pgaABCD*, responsible for synthesis of a biofilm polysaccharide adhesin of *Escherichia coli*. *Mol Microbiol* **56**: 1648-1663.
- Wei, B. L., A. M. Brun-Zinkernagel, J. W. Simecka, B. M. Pruss, P. Babitzke and T. Romeo. (2001) Positive regulation of motility and *flhDC* expression by the RNA-binding protein CsrA of *Escherichia coli*. *Mol Microbiol* **40**: 245-256.
- Weilbacher, T., K. Suzuki, A. K. Dubey, X. Wang, S. Gudapaty, I. Morozov, C. S. Baker, D. Georgellis, P. Babitzke and T. Romeo. (2003) A novel sRNA component of the carbon storage regulatory system of *Escherichia coli*. *Mol Microbiol* **48**: 657-670.

- Wendrich, T. M., G. Blaha, D. N. Wilson, M. A. Marahiel and K. H. Nierhaus. (2002) Dissection of the mechanism for the stringent factor RelA. *Mol Cell* **10**: 779-788.
- White, D., M. E. Hart and T. Romeo. (1996) Phylogenetic distribution of the global regulatory gene *csrA* among eubacteria. *Gene* **182**: 221-223.
- Yakhnin, A. V., J. J. Trimble, C. R. Chiaro and P. Babitzke. (2000) Effects of mutations in the L-tryptophan binding pocket of the Trp RNA-binding attenuation protein of *Bacillus subtilis*. *J Biol Chem* **275**: 4519-4524.
- Yakhnin, H., P. Pandit, T. J. Petty, C. S. Baker, T. Romeo and P. Babitzke. (2007) CsrA of *Bacillus subtilis* regulates translation initiation of the gene encoding the flagellin protein (*hag*) by blocking ribosome binding. *Mol Microbiol* **64**: 1605-1620.
- Yang, H., Liu, M.Y., and Romeo, T. (1996) Coordinate genetic regulation of glycogen catabolism and biosynthesis in *Escherichia coli* via the CsrA gene product. *J Bacteriol* **178**: 1012-1017.

Table 2-1. COG assignments for RNAs that copurified with CsrA-His₆

COGs	Description	Number	Percentage of genes in COG	Overlap with <i>dksA</i> and ppGpp responsive genes^a
J	Translation, ribosomal structure and biogenesis	37	20.3	16
K	Transcription	40	12.2	13
L	DNA replication, recombination and repair	27	11.4	7
D	Cell division and chromosome partitioning, cell cycle control	7	19.4	1
O	Posttranslational modification, protein turnover, chaperones	34	24.3	14
M	Cell wall, membrane and envelope biogenesis	39	15.9	5
N	Cell motility and secretion	8	7.0	3
P	Inorganic ion transport and metabolism	31	10.9	16
T	Signal transduction mechanisms	20	9.5	9
C	Energy production and conversion	69	22.2	47
G	Carbohydrate transport and metabolism	61	14.3	25
E	Amino acid transport and metabolism	68	15.2	34
F	Nucleotide transport and metabolism	13	14.1	7
H	Coenzyme transport and metabolism	23	15.1	6
I	Lipid transport and metabolism	19	17.6	7
V	Defense mechanisms	3	6.0	0
U	Intracellular trafficking and secretion	5	3.7	3

Q	Secondary metabolites biosynthesis, transport and catabolism	6	7.4	1
R	General function prediction only	42	8.1	15
S	Function unknown	25	7.7	9
	COG Unassigned; Uncharacterized	136		46
RNAs	Regulatory RNAs, tRNAs	8		NA
Total		721		284

^aData for genes within each COG, which also respond to ppGpp, *dksA*, or both, were from Aberg *et al.*, 2009. Only exact gene matches (not operons) were tabulated.

FIGURE LEGENDS

Fig. 2-1. Gel shift analyses of CsrA binding to mRNA leaders of *relA*, *dksA*, *gmk* and *rpoZ*. (A) The nucleotide sequences of *relA*, *gmk*, *rpoZ* and *dksA* mRNA leaders are shown with putative CsrA binding sites underlined. Positions of the experimentally determined transcriptional starts are depicted as capital letters, and positions of the Shine-Dalgarno (SD) sequences and initiation codons (Met) are shown. (B) The structure of the *spo* operon; arrows denote promoters while asterisks indicate potential CsrA binding sites. (C-I) RNA gel shifts: 5'-end-labeled transcripts (80 pM) were incubated with CsrA at the concentration indicated below each lane. Reactions were performed in the absence (C, E, G and H) or presence (D, F and I) of specific or nonspecific (*trp* from *B. subtilis*) unlabeled RNA competitors, at the concentrations shown. The positions of free (F) and bound (B) RNA are shown. (C, D) CsrA-*relA* interaction. (E, F) CsrA-*dksA* interaction. (G) CsrA-*gmk* interaction. (H, I) CsrA-*rpoZ* interaction.

Fig. 2-2. Effects of *csrA* on expression of *relA*, *spoT* and *dksA* reporter fusions. Cells were harvested at various times throughout growth and assayed for β -galactosidase specific activity (A_{420} / mg protein). The values represent the average of two independent experiments. Error bars depict standard error of the mean. (A-E) Activity of indicated fusions in wild-type, ■; *csrA*, ▲; *csrA* pGB2 (empty vector), ▼; and *csrA* pCsrA (*csrA*⁺), ●. (E) Strain identities were identical, except pBR322 (empty vector, ▼) and pCRA16 (*csrA*⁺, ●) were used for complementation. Growth curves are represented by open symbols.

Fig. 2-3. Effect of *csrA* on *relA*, *spoT* and *dksA* transcript levels, measured by real-time qRT-PCR, using strains MG1655 (wild-type) and TRMG1655 (*csrA* mutant). Samples were taken at exponential phase ($OD_{600} = 0.5$) and stationary phase (at 8 hours of growth). The values represent the average of two independent experiments. Error bars depict standard error of the mean (** $P < 0.001$).

Fig. 2-4. Effect of *csrA* disruption and complementation on RelA, GMK and DksA protein levels by western blot analyses. Shown below each representative blot, the PVDF membrane was stained using the MemCode™ Reversible Protein Stain Kit (Pierce Biotechnology, Rockford, IL) and imaged as an internal loading control. Protein was harvested at exponential ($OD_{600} = 0.5$) and stationary phases (after 8 hours of growth). (A) RelA; Lane 1,6 MG1655; Lane 2,7 *csrA::kan*; Lane 3,8 *csrA::kan* pGB2; Lane 4,9 *csrA::kan* pCsrA; Lane 5, *relA::kan spoT::cat*. (B) GMK; Lane 1,5 MG1655; Lane 2,6 *csrA::kan*; Lane 3,7 *csrA::kan* pGB2; Lane 4,8 *csrA::kan* pCsrA; and Lane 9, CF80005 (pGMK). (C) DksA; Lane 1,6 MG1655; Lane 2,7 *csrA::kan*; Lane 3,8 *csrA::kan* pGB2; Lane 4,9 *csrA::kan* pCsrA; Lane 5, *dksA::kan*. Fold differences in protein levels (relative to wild-type) are indicated and represent an average of three independent experiments. The standard deviation for all values was less than 10% from the mean.

Fig. 2-5. Effects of *dksA* and *csrA* on expression of chromosomally-encoded *dksA* translational, transcriptional, and leader fusions. (A-D) Cells were harvested at various times throughout growth and assayed for β -galactosidase specific activity (A_{420} / mg protein). Values represent the average of two independent experiments. Error bars depict

standard error of the mean. (A) Activity from a *dksA*'-'*lacZ* fusion in wild-type, ■; *dksA*, ▲; *dksA* pHM1883 (empty vector), ▼; *dksA* pHM1506 (*dksA*⁺), ◆; *dksA* pHM1506 + 0.1 mM IPTG, ●; and *dksA* pHM1506 + 1 mM IPTG, *. Growth curves are represented by open symbols except for *dksA* pHM1506 + 1 mM IPTG (+). (B-D) Activity from the indicated fusions in wild-type, ■; *csrA*, ▲; *dksA*, ▼; and *csrA dksA*, ●. Growth curves are represented by open symbols.

Fig. 2-6. Effect of *dksA* on *dksA* transcription. (A) Nucleotide sequence of the *dksA* promoters. Positions of the mapped P1 and putative P2 transcriptional starts are depicted as capital letters, and predicted -35 and -10 promoter elements are shown. Numbering is with respect to the start of *dksA* translation. (B) Primer extension analysis of the *dksA* 5' end. Lane 1, *dksA* (disrupted with *kan*); Lane 2, *dksA* pHM1684 (*dksA* containing the D71N and D74N mutations); Lane 3, *dksA* pJK537 (wild-type *dksA*); Lane 4, WT; Lane 5, *dksA* (disrupted with *tet* downstream from the AUG translational start). The dideoxynucleotide sequencing ladder (G, A, T and C) was generated with the same primer (pdksA2) used for the primer extension analysis.

Fig. 2-7. Effects of *dksA*, ppGpp and *rpoS* on *csrA* expression. (A) Western blot of CsrA protein levels in MG1655 (wild-type) and *dksA* mutant strains (upper panel) and PVDF membrane stained with the MemCodeTM Reversible Protein Stain Kit (Pierce Biotechnology, Rockford, IL) and imaged as an internal loading control (lower panel). Cells were harvested at exponential phase (OD₆₀₀ = 0.5) and stationary phase (at 8 hours of growth). Lane 1, MG1655; Lane 2, *dksA::kan*; Lane 3, *dksA::kan* pHM1883 (empty

vector); Lane 4, *dksA::kan* pHM1506 (*dksA*⁺); Lane 5, *dksA::kan* pHM1506 + 0.1 mM IPTG; Lane 6, *relA spoT* (ppGpp⁰). Fold differences in protein levels (relative to wild-type) are indicated and represent an average of three independent experiments. The standard deviation for these values was < 10% from the mean. (B-F) Cells were harvested at various times throughout growth and assayed for β -galactosidase specific activity (A_{420} / mg protein). The values represent the average of two independent experiments. Error bars depict standard error of the mean. (B) Activity from a chromosomal *csrA*'-'*lacZ* translational fusion: CF7789 (wild-type), ■; *dksA*, ▲; *dksA* pHM1883 (empty vector), ▼; *dksA* pHM1506 (*dksA*⁺), ◆; *dksA* pHM1506 + 0.1 mM IPTG, ●; and *relA spoT* (ppGpp⁰), *. (C) Activity from a chromosomal *csrA*'-'*lacZ* translational fusion: CF7789 (wild-type), ■; *dksA*, ▲; *rpoS*, ▼; *dksA rpoS*, ◆; *dksA rpoS* pHM1883 (empty vector), ●; and *dksA rpoS* pHM1506 (*dksA*⁺) + 0.1 mM IPTG, *. Growth curves are represented by open symbols except for *dksA rpoS* pHM1506 + 1 mM IPTG (+). (D-E) Activity from the indicated fusions in wild-type, ■; *dksA*, ▲; and *relA spoT* (ppGpp⁰), *. Growth curves are represented by open symbols.

Fig. 2-8. Effects of *dksA* and ppGpp on CsrB and CsrC RNA levels and gene expression.

(A) A representative Northern blot of RNA from MG1655 (WT) and isogenic mutants is shown. A plasmid vector (pHM1883) and a *dksA* expression plasmid (pHM1506) were used for *dksA* complementation analysis. Fold differences in RNA levels (relative to wild-type) are indicated and represent an average of three independent experiments. The standard deviation for all values was <10% from the mean. (B, C) Cells were harvested at various times throughout growth and assayed for β -galactosidase specific activity (A_{420}

/ mg protein). The values represent the average of two independent experiments, and error bars depict the standard error of the mean. Activity from indicated fusions in wild-type, ■; *dksA*, ▲; *dksA* pHM1883 (empty vector), ▼; *dksA* pHM1506 (*dksA*⁺), ◆; *dksA* pHM1506 (*dksA*⁺) + 0.1 mM IPTG, ●; and *relA spoT* (ppGpp⁰), *. Growth curves are represented by open symbols except for *relA spoT* (ppGpp⁰) (+). (D, E) Epistasis studies with *csrB-lacZ* (D) and *csrC-lacZ* transcriptional fusions (E) in *dksA*, *uvrY* and *dksA uvrY* backgrounds with ectopic expression of *uvrY* (pUY14) or *dksA* (pHM1506) at 8 hours of growth. The vector controls were pBR322 and pHM1883, respectively. (F, G) Epistasis studies with *csrB-lacZ* (F) and *csrC-lacZ* transcriptional fusions (G) in *dksA*, *csrA* and *dksA csrA* backgrounds with ectopic expression of *csrA* (pCsrA) or *dksA* (pHM1506) at 8 hours of growth. The vector controls were pGB2 and pHM1883, respectively.

Fig. 2-9. Regulatory interactions within and between the Csr and stringent response systems in *E. coli*. CsrA activates *csrB* and *csrC* expression through the BarA-UvrY two component signal transduction system (Suzuki *et al.*, 2002; Weilbacher *et al.*, 2003). In turn, CsrB and CsrC RNAs sequester and antagonize CsrA (Liu *et al.*, 1997; Weilbacher *et al.*, 2003). CsrA represses expression of CsrD, which mediates the RNase E-dependent turnover CsrB and CsrC (Suzuki *et al.*, 2006). Here, we show that DksA and ppGpp also activate transcription of CsrB and CsrC RNAs via the UvrY response regulator. The effects of CsrA, ppGpp and DksA on CsrB and CsrC may be partly mediated via effects on acetate accumulation and BarA signaling, but predominantly involve other uncharacterized mechanism(s). DksA and ppGpp also activate *csrA* expression in RpoS-dependent and independent mechanisms, although their effects on

CsrA levels are weaker than on CsrB and CsrC RNAs. CsrA binds tightly to *relA* mRNA and represses *relA* expression post-transcriptionally. CsrA binds with lower affinity to *dksA* mRNA and activates *dksA* expression post-transcriptionally. However, DksA negative autoregulation tends to mask the effects of CsrA. CsrA appears to indirectly repress *spoT* transcript levels through an unknown factor (X). Broken lines emphasize uncertain mechanisms.

Fig. 2-2.

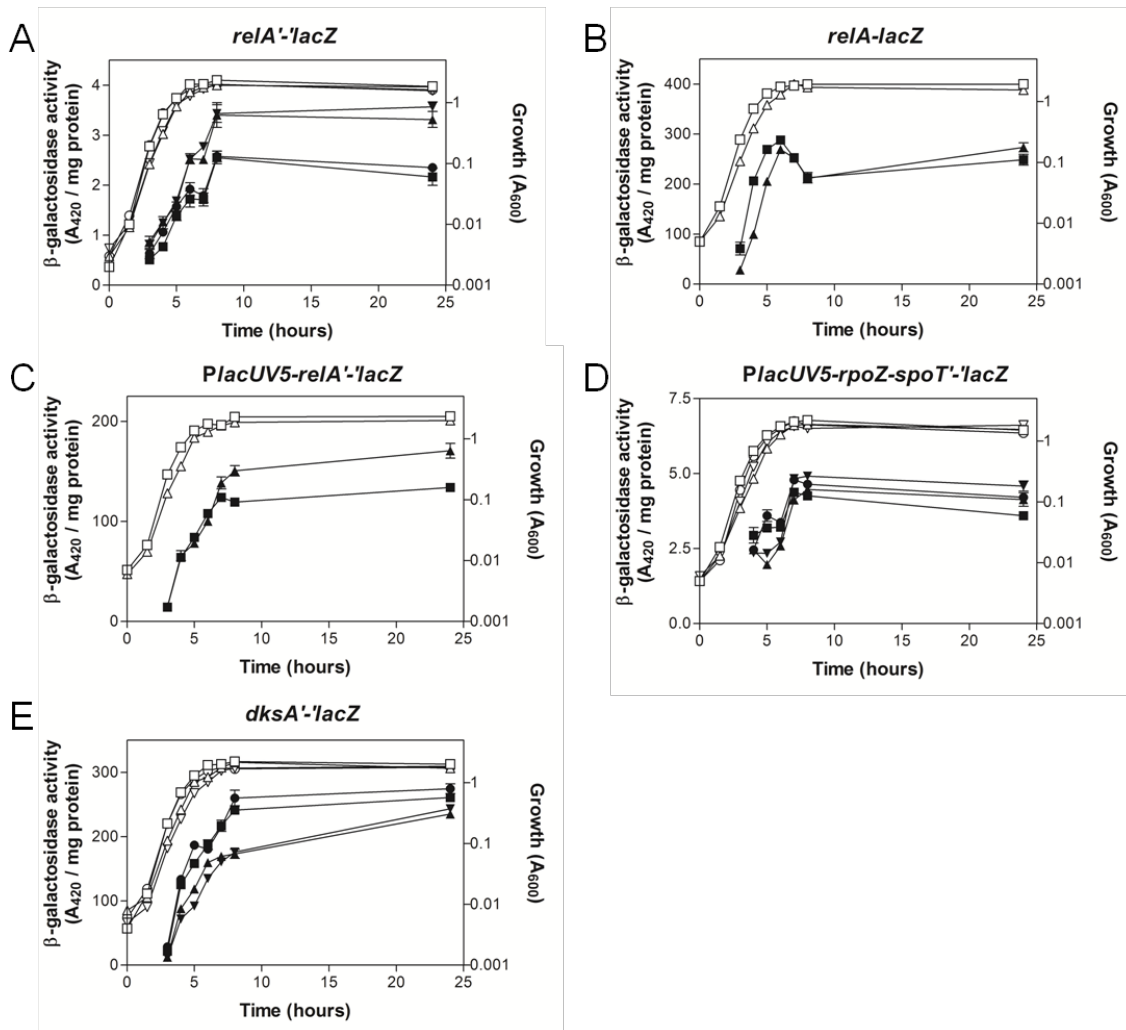


Fig. 2-3.

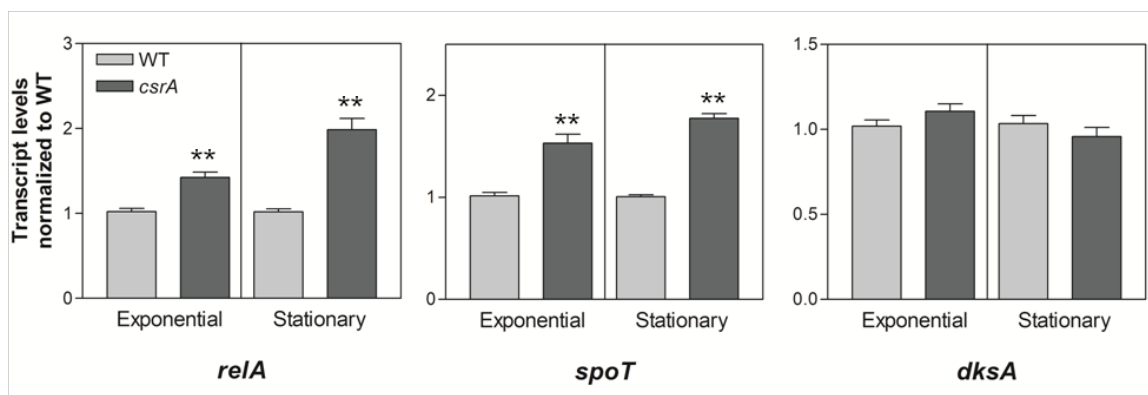


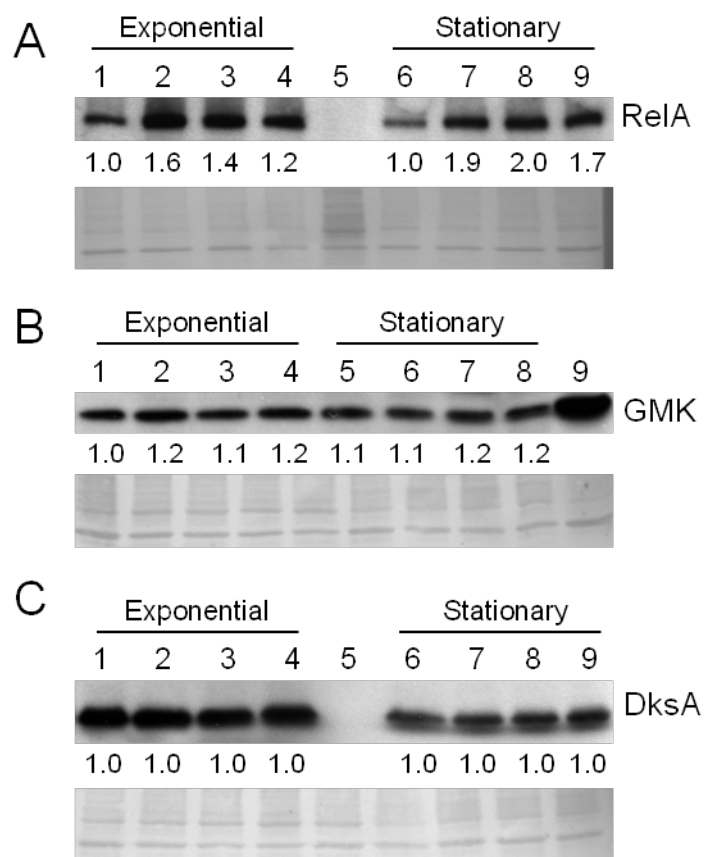
Fig. 2-4.

Fig. 2-5.

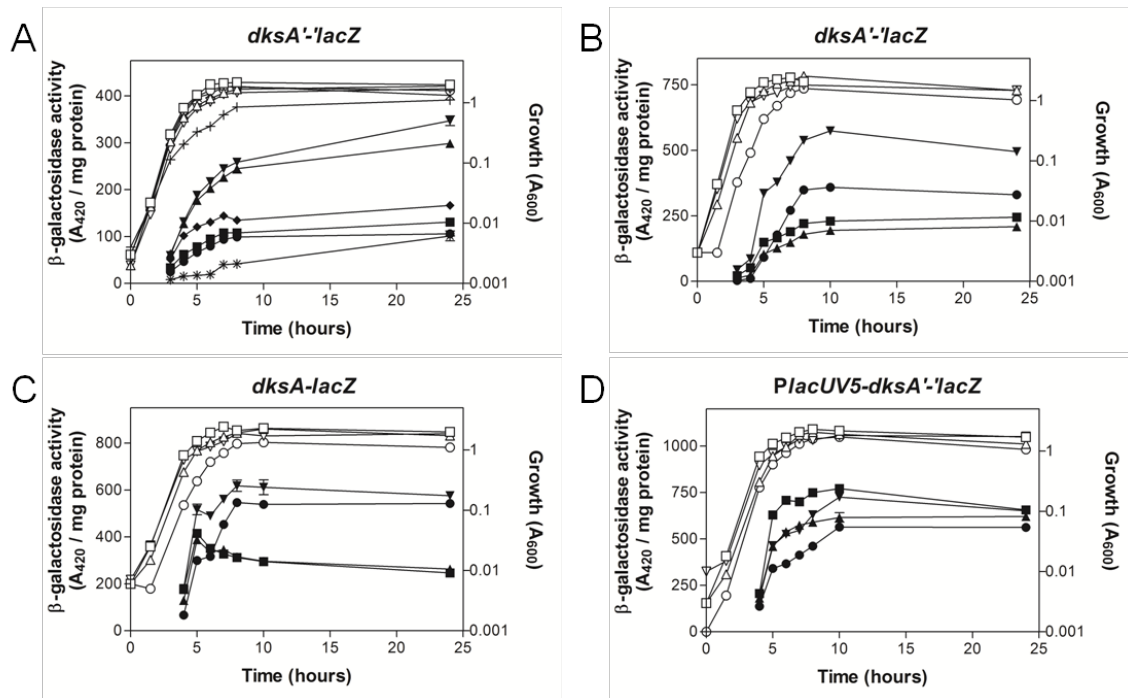


Fig. 2-7.

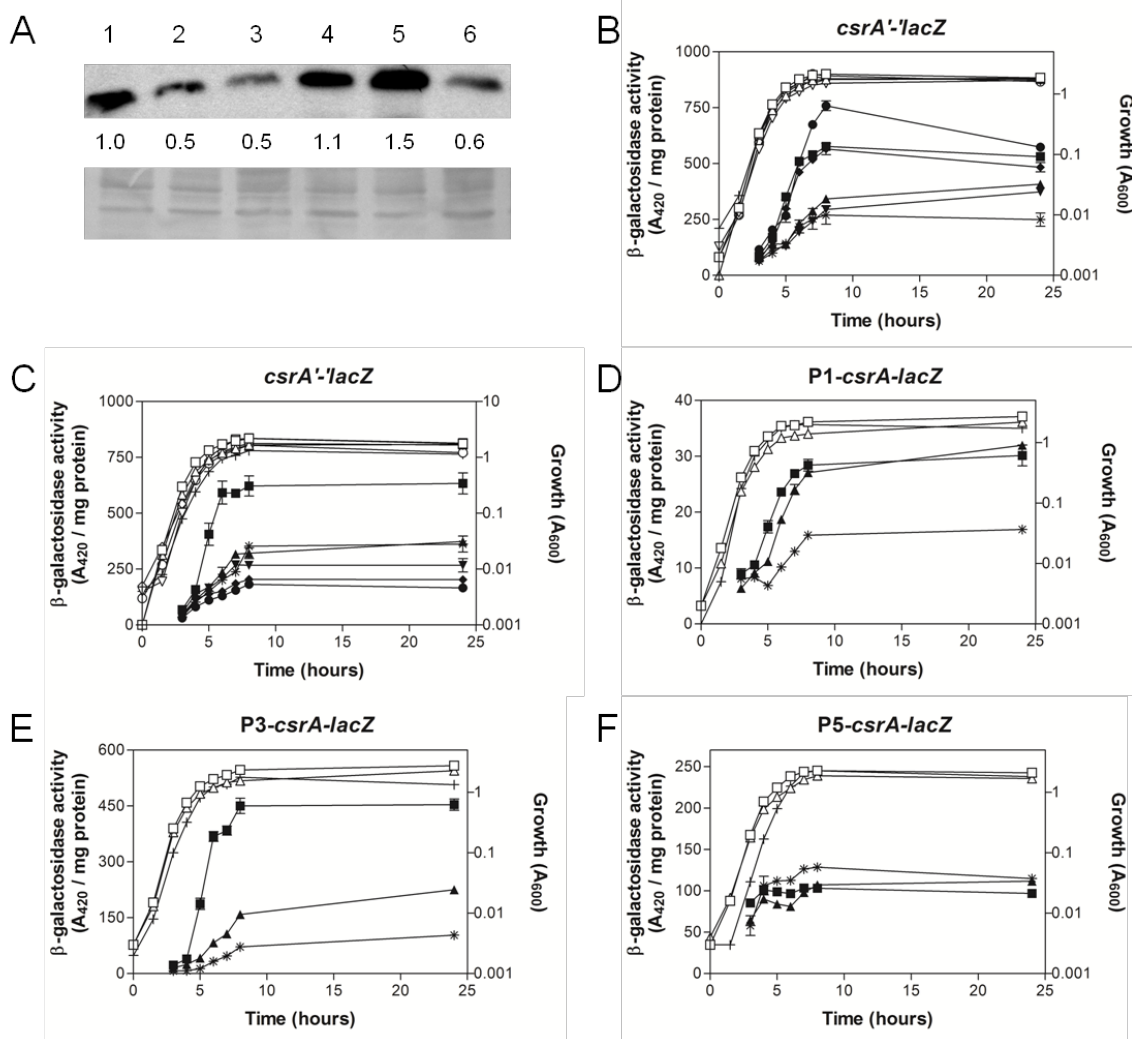


Fig. 2-8.

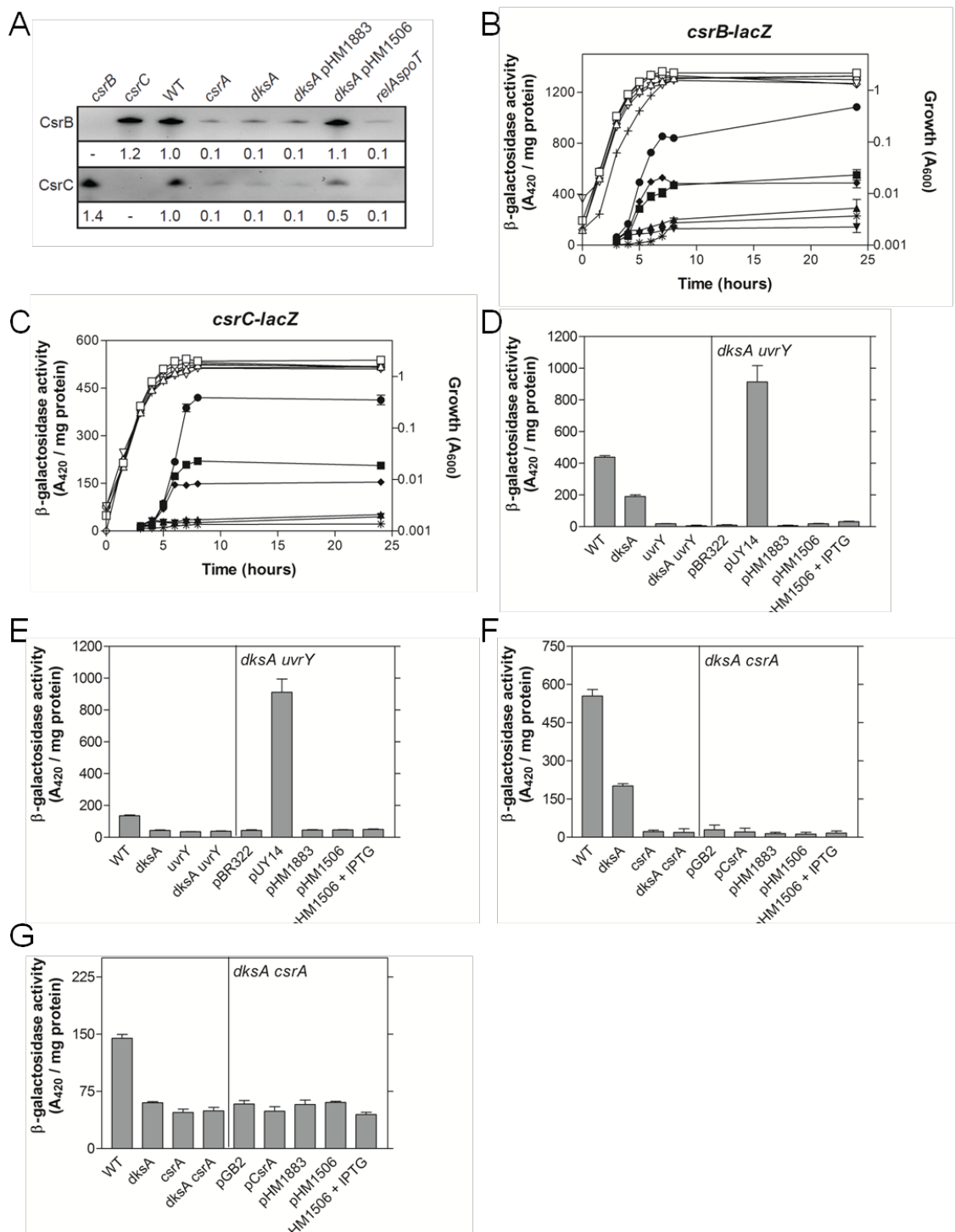
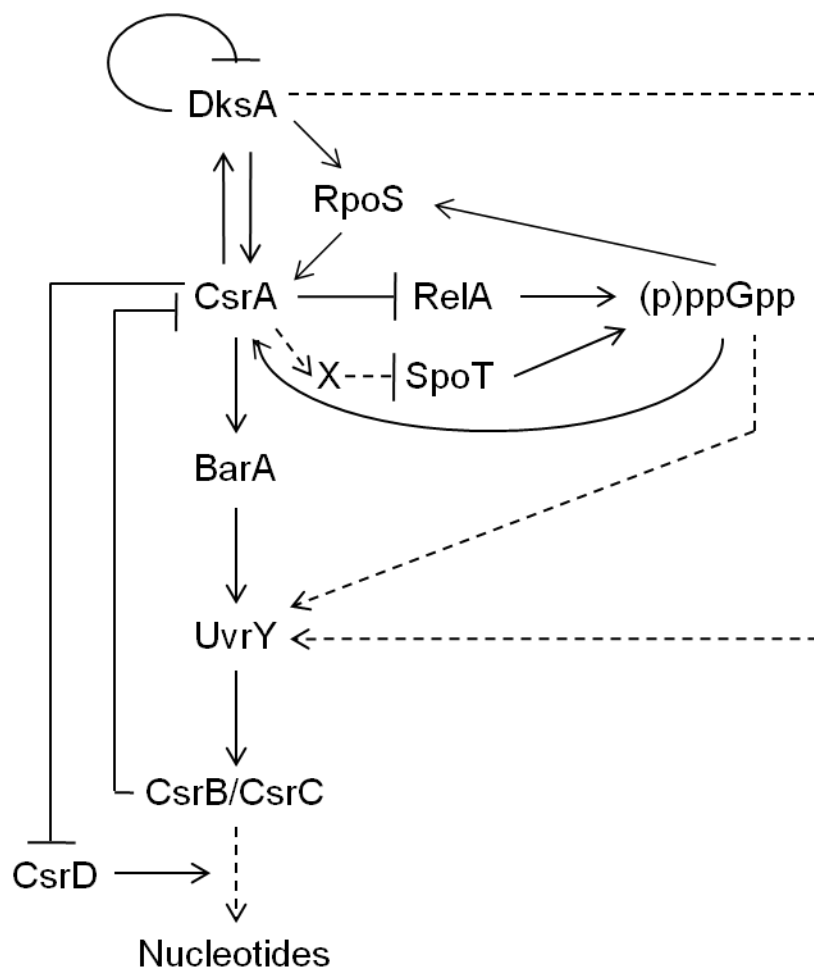


Fig. 2-9.



Chapter 3. The RNA binding protein CsrA controls cyclic-di-GMP levels by directly regulating expression of GGDEF proteins

Kristina Jonas^{1,2}, Adrienne N. Edwards³, Roger Simm², Tony Romeo^{3,4}, Ute Römling² and Öjar Melefors^{1,2*}

¹Swedish Institute for Infectious Disease Control, SE-17182, Solna, Sweden, ²Department of Microbiology, Tumor and Cell Biology, Karolinska Institutet, SE-17177 Stockholm, Sweden, ³Department of Microbiology and Immunology, Emory University School of Medicine, Atlanta, Georgia 30322, USA, ⁴Department of Microbiology and Cell Science, University of Florida, Gainesville, Florida 32611-0700, USA, Correspondence to *E-mail ojar.melefors@ki.se; Fax (+46) 830 2566; Tel. (+46) 845 72414.

This manuscript was published in *Mol Micro*. 2008 Oct;70(1):236-57. Adrienne N. Edwards performed the RNA electrophoretic mobility shift assays in this study.

ABSTRACT

The carbon storage regulator CsrA is an RNA binding protein that controls carbon metabolism, biofilm formation and motility in various eubacteria. Nevertheless, in *Escherichia coli* only five target mRNAs have been shown to be directly regulated by CsrA at the post-transcriptional level. Here we identified two new direct targets for CsrA, *ycdT* and *ydeH*, both of which encode proteins with GGDEF domains. A *csrA* mutation caused mRNA levels of *ycdT* and *ydeH* to increase more than 10-fold. RNA mobility shift assays confirmed the direct and specific binding of CsrA to the mRNA leaders of *ydeH* and *ycdT*. Overexpression of *ycdT* and *ydeH* resulted in a more than 20-fold increase in the cellular concentration of the second messenger cyclic di-GMP (c-di-GMP), implying that both proteins possess diguanylate cyclase activity. Phenotypic characterization revealed that both proteins are involved in the regulation of motility in a c-di-GMP-dependent manner. CsrA was also found to regulate the expression of five additional GGDEF/EAL proteins and a *csrA* mutation led to modestly increased cellular levels of c-di-GMP. All together, these data demonstrate a global role for CsrA in the regulation of c-di-GMP metabolism by regulating the expression of GGDEF proteins at the post-transcriptional level.

INTRODUCTION

Successful adaptation of bacteria to different niches depends on their ability to adjust their life style according to the requirements of the environment. Bacteria have evolved numerous mechanisms to sense external signals, to translate them into complex cellular responses and, thereby, to mediate responses to physiological demands. The

Escherichia coli carbon storage system, with the RNA binding protein CsrA as the central player, exemplifies such an adaptive regulatory cascade (see reviews by Babitzke and Romeo, 2007; Lucchetti-Miganeh *et al.*, 2008). The Csr regulatory system is widely distributed among eubacteria (White *et al.*, 1996) and has been found to control a variety of virulence-linked physiological traits (Lucchetti-Miganeh *et al.*, 2008).

CsrA was originally identified as a regulator of glycogen biosynthesis (Romeo *et al.*, 1993), acting as an RNA binding protein on the expression of its target mRNAs (Liu and Romeo, 1997). Beside controlling glycogen synthesis, CsrA and its homologues in various bacteria have widespread regulatory functions, including roles in biofilm formation (Jackson *et al.*, 2002; Wang *et al.*, 2005), motility (Wei *et al.*, 2001; Yakhnin *et al.*, 2007), carbon metabolism (Sabnis *et al.*, 1995; Baker *et al.*, 2002), secondary metabolism (Heeb and Haas, 2001; Heeb *et al.*, 2005; Kay *et al.*, 2005), quorum sensing (Heurlier *et al.*, 2004; Lenz *et al.*, 2005) and numerous functions in the interactions with animal and plant hosts (Altier *et al.*, 2000; Heeb and Haas, 2001; Barnard *et al.*, 2004). CsrA is a homodimer containing two identical RNA binding surfaces located on opposite sides of the protein, whose structure and function recently have been elucidated in considerable detail (Mercante *et al.*, 2006; Schubert *et al.*, 2007). Despite its global role in bacterial adaptation, only a few direct mRNA targets have been identified, including five in *E. coli*. By binding to mRNA leaders and preventing translation, followed by destabilizing of the transcript, CsrA has been shown to downregulate expression of the *glgCAP* operon (Baker *et al.*, 2002), encoding the glycogen synthesis apparatus, the *cstA* gene (Dubey *et al.*, 2003), involved in carbon starvation and the *pga* operon, encoding the biofilm polysaccharide poly β -1,6-N-acetyl-D-glucosamine (PGA) (Wang *et al.*, 2005).

Regulation of the RNA chaperone gene *hfq* is also mediated by CsrA binding and translation inhibition, although this does not result in *hfq* mRNA destabilization (Baker *et al.*, 2007). CsrA also upregulates the expression of certain target genes. The mRNA of *flhDC*, which is required for flagellum biosynthesis, is stabilized by CsrA binding to the *flhDC* leader (Wei *et al.*, 2001). However, the detailed biochemical mechanism for this activation has not been elucidated.

Regulation of CsrA activity is mediated in part by the action of the two small non-coding RNAs (sRNAs) CsrB and CsrC (Romeo, 1998; Weilbacher *et al.*, 2003). During the past years sRNAs have been recognized as important players in gene regulation, in most cases by base pairing with target mRNAs (Majdalani *et al.*, 2005; Storz *et al.*, 2005; Romby *et al.*, 2006). However, CsrB and CsrC RNAs antagonize the activity of CsrA by binding to and therefore sequestering this protein (Liu *et al.*, 1997). Transcription of the Csr sRNAs is controlled by the two-component system BarA-UvrY (Suzuki *et al.*, 2002; Weilbacher *et al.*, 2003), thus permitting the integration of environmental signals into the Csr signalling network. Expression of *csrB* and *csrC* also requires CsrA. This regulation may be mediated indirectly through the BarA-UvrY system (Gudapaty *et al.*, 2001; Suzuki *et al.*, 2002). This auto-regulatory mechanism has been described as a homeostatic system, which leads to tight regulation of CsrA activity. Recently, a new regulatory factor, CsrD (YhdA) has been shown to influence the Csr system (Jonas *et al.*, 2006; Suzuki *et al.*, 2006). By targeting CsrB and CsrC for degradation by RNase E, CsrD acts positively on CsrA activity (Suzuki *et al.*, 2006). The apparent membrane protein CsrD contains degenerate GGDEF and EAL domains. Such domains have been shown to be associated with the turnover of the second messenger cyclic di-GMP (c-di-

GMP) (Simm *et al.*, 2004; Ryjenkov *et al.*, 2005; Schmidt *et al.*, 2005), which can mediate the switch between a motile and sessile life style in diverse bacteria (see reviews by D'Argenio and Miller, 2004; Jenal, 2004; Romling, 2005; Romling and Amikam, 2006). In contrast to other GGDEF/EAL proteins, CsrD was demonstrated to lack both diguanylate cyclase (DGC) and phosphodiesterase activities, indicating that CsrD is involved neither in the production nor in the degradation of the second messenger (Suzuki *et al.*, 2006). In contrast, CsrD was found to be an RNA binding protein, although its detailed mechanism of action in CsrB/C decay has not been resolved. Despite the detailed knowledge about the molecular mechanisms of the Csr signalling system, limited information is available concerning the integration of the Csr cascade into other global networks. In order to identify novel direct targets for CsrA that might help us to better understand the global impact of the Csr network, we conducted a genome-wide search for genes, whose transcript levels rapidly change upon pulse overproduction of CsrA. Our search revealed that CsrA is a regulator for several GGDEF/EAL proteins, in particular of the two GGDEF proteins YcdT and YdeH. Both proteins produce c-di-GMP *in vivo* and control flagella-mediated swimming motility.

RESULTS

Identification of novel mRNA targets for CsrA by microarray. To screen for novel direct CsrA targets we decided to adopt a microarray-based approach, which has previously been used to identify direct sRNA targets (Papenfort *et al.*, 2006; Tjaden *et al.*, 2006; Vogel and Wagner, 2007). Our strategy involved the pulse overexpression of *csrA*, followed by the immediate analysis of changes in whole-genome expression

patterns. The approach is based on the assumption that CsrA not only blocks the translation of many of its mRNA targets, but also secondarily destabilizes them. Hence, pulse overexpression of CsrA from an inducible vector is expected to lead to a rapid decrease in the transcript level of the directly regulated targets. Changes in the transcript levels of indirect CsrA targets are assumed to occur first at later time points after *csrA* induction. Such differential changes in the transcript level can be monitored over time by microarray analysis. To verify that our approach was working, we first monitored *csrA* expression as well as the expression of the known direct target *pgaA* and the known indirect target *csrB* in response to *csrA* overexpression by quantitative real-time reverse transcriptase PCR (RT-PCR). Our data show that addition of arabinose (at 0 min) to *E. coli* KJ157 (KSB837 *csrA::kan*), carrying the arabinose-inducible vector pBAD_{csrA}, resulted in a strong upregulation of *csrA* expression within 2 min (Fig. 3-1A). Consistent with our prediction mRNA levels of the direct target *pgaA* dramatically decreased within less than 10 min (Fig. 3-1B). The expression of the sRNA CsrB, known to be indirectly and positively controlled by CsrA (Gudapaty *et al.*, 2001), began to increase after a delay of ~12 min (Fig. 3-1C). These data suggest that our approach was successful in discriminating between direct and indirect targets for CsrA.

In the next step we screened for novel direct CsrA targets by using an Affymetrix whole-genome *E. coli* array. As *pgaA* mRNA was downregulated within less than 12 min, we compared the transcriptional profiles 4 and 12 min after arabinose addition with the profile before arabinose induction (0 min). To eliminate genes downregulated in a CsrA-independent manner, we normalized the observed signal ratios against the signal ratios resulting from induction of the vector control pBAD28.

Four of the genes showing the strongest repression (more than sevenfold) 12 min after pBAD_{csrA} expression belonged to the *pga* operon (Fig. 3-1D). The mRNA levels of *ycdT* followed the same kinetics upon CsrA overexpression as the *pga* mRNAs, suggesting that *ycdT* may be regulated by CsrA in a similar manner. Database search revealed that *ycdT* is located directly adjacent to the *pga* operon but on the reverse strand. *ycdT* encodes a transmembrane protein with a C-terminal GGDEF domain (Fig. 3-1E and F). Among the most downregulated genes in response to CsrA overexpression we found another GGDEF protein encoding open reading frame, *ydeH* (Fig. 3-1D and G). *ydeH* is predicted to encode a cytoplasmic protein, not containing any known domains involved in signalling (Fig. 3-1G).

The two GGDEF proteins YcdT and YdeH are regulated by CsrA. To confirm the effect of CsrA overexpression on *ycdT* and *ydeH* transcripts, we determined the kinetics of CsrA-dependent downregulation by RT-PCR. In accordance with our array data, *ycdT* and *ydeH* mRNA levels decreased strongly upon arabinose addition in late exponential phase (OD₆₀₀ 1.5) (Fig. 3-2A). The mRNA level of *ycdT* was halved within 4 min and reached a minimum of 3% between 12 and 24 min. *ydeH* mRNA decreased to 50% within 5 min and continued to decrease to approximately 22% after 24 min. Similar results were observed when arabinose induction was performed earlier during growth at OD₆₀₀ 0.5 (Fig. 3-2B). In contrast, addition of arabinose to a strain carrying the empty vector pBAD28 did not affect the levels of *ycdT* and *ydeH* transcripts (Fig. 3-2C).

To test the effect of a *csrA* mutation on *ycdT* and *ydeH* expression, we measured the mRNA levels of *ycdT* and *ydeH* by RT-PCR along the entire growth curve in the wild-type and isogenic *csrA* mutant strains. In the wild-type strain, expression of *ycdT*

slightly decreased within the first 8 h of growth (Fig. 3-2D), whereas *ydeH* mRNAs remained at constant levels (Fig. 3-2E). Between 8 and 24 h the expression of both genes strongly increased. In the *csrA* mutant, *ycdT* and *ydeH* mRNA levels were significantly elevated. *ycdT* expression was more strongly upregulated (up to 30-fold) during exponential growth compared with later time points (Fig. 3-2D), whereas the transcript levels of *ydeH* were approximately 10-fold higher throughout the growth (Fig. 3-2E). Monitoring *csrA* transcript levels over time in the wild-type strain shows that *csrA* expression rapidly decreased between 8 and 24 h (Fig. 3-2F), demonstrating that *csrA* is inversely regulated with *ycdT* and *ydeH*. However, the fact that CsrA activity is in large part under the control of CsrB and CsrC makes it difficult to correlate *csrA* mRNA levels with its activity. Nevertheless, these data confirm that CsrA is a negative regulator of *ycdT* and *ydeH* expression.

Effects of other components of the BarA-UvrY-Csr cascade on *ydeH* and *ycdT* expression. CsrA is antagonized by the CsrB and CsrC sRNAs. These sRNAs are transcriptionally activated by the BarA-UvrY two-component system and negatively controlled by CsrD at the level of RNA stability (Suzuki *et al.*, 2002; 2006; Weillbacher *et al.*, 2003). By using genetic mutants we tested the contribution of these components on *ycdT* and *ydeH* expression. Disruption of *csrB* and *csrC* resulted in a slight decrease in *ycdT* and *ydeH* mRNA levels (approximately 70%) compared with the wild type (Fig. 3-3). Similar weak effects were observed in *uvrY* and *barA* mutants. These modest effects are consistent with the earlier finding that levels of CsrA protein normally exceeds the binding capacity of these small RNAs (Gudapaty *et al.*, 2001). A more pronounced effect on *ycdT* and *ydeH* mRNAs was observed in a *csrD* mutant, in which the cellular levels of

CsrB and CsrC are increased. Compared to the wild type the mRNA levels of *ycdT* and *ydeH* were approximately threefold increased (Fig. 3-3). All together, these results indicate that the entire Csr regulatory network is involved in the regulation of the expression of *ycdT* and *ydeH*.

CsrA directly interacts with the *ycdT* and *ydeH* transcripts. Previous studies have suggested that CsrA binds to the consensus sequence, ACA-GGAUG, with the GGA motif representing the most highly conserved nucleotides (Baker *et al.*, 2002; Dubey *et al.*, 2005). To make predictions about the binding of CsrA to the *ycdT* and *ydeH* mRNAs, we analysed the 5' leader sequences of both transcripts for the existence of potential CsrA binding motifs. As no information about the *ycdT* promoter was available in the database, we determined the transcriptional initiation site of *ycdT* by Rapid Amplification of 5'-cDNA Ends (5' RACE). A single band was observed for a PCR reaction, amplifying the 5' non-translated region of the *ycdT* transcript (Fig. 3-4A). Sequencing of the RACE PCR product identified the nucleotide A, 35 bp upstream of AUG, as the transcription start site. The -10 and -35 regions of *ycdT* [TATTAA (-10) and TTGACA (-35)], separated by a 19 bp spacing region, exhibited 4 and 6 bp of identity with respect to the consensus sequences for these promoter elements [TATAAT (-10) and TTGACA (-35)] (Hawley and McClure, 1983). We identified two potential CsrA binding sites with degenerate motifs in the 5' non-translated region of the *ycdT* mRNA, one of them close to the transcription start and the other one overlapping the AUG translation initiation start codon (Fig. 3-4A). The *ydeH* transcript starts 29 nucleotides upstream of the initiation codon AUG (Yamamoto and Ishihama, 2006). Also in the 5' non-translated region of the *ydeH* mRNA two potential CsrA binding sites were

found, one of which overlaps the Shine–Dalgarno sequence and the other one is close to the 5' end of the transcript (Fig. 3-4B).

To experimentally determine whether CsrA directly binds to the *ycdT* and *ydeH* transcripts, quantitative RNA gel mobility shift assays were performed with a *ycdT* transcript, consisting of a 36 nt leader and the first 20 nt of the coding region, and a *ydeH* transcript containing the 29 nt untranslated leader and the first 25 nt of the coding sequence. CsrA bound strongly to both *ycdT* and *ydeH* transcripts (Fig. 3-4C and D). For the *ycdT* transcript, two distinct complexes were observed at 2.5 nM CsrA, and essentially all of the starting RNA was shifted at 80 nM CsrA (Fig. 3-4C). For the *ydeH* transcript, two distinct shifted complexes were formed at 5 nM CsrA. However, complete binding was not seen until 320 nM CsrA, and at this concentration essentially all of the RNA was present in the upper complex (Fig. 3-4D). These gel shift patterns suggested that two CsrA proteins were bound to each transcript at higher CsrA concentrations, although the stoichiometry of binding was not experimentally determined. A non-linear least-squares analysis of these data yielded an apparent equilibrium binding constant (K_d) of 2.6 ± 0.3 nM for *ycdT* and 2.3 ± 0.1 nM for *ydeH*.

The specificity of CsrA interaction with *ycdT* and *ydeH* transcripts was investigated by performing competition experiments with specific (*ycdT* or *ydeH* transcripts) and non-specific (*Bacillus subtilis trp* leader) unlabelled RNA competitors. Both *ycdT* and *ydeH* RNAs were able to compete for binding to CsrA while *B. subtilis trp* RNA did not effectively compete with the CsrA–*ycdT* or CsrA–*ydeH* interaction (Fig. 3-4E and F). These results establish that CsrA binds specifically to both *ycdT* and *ydeH* RNA.

In most cases CsrA downregulates its direct mRNA targets by binding to the leader, preventing translation and destabilizing the transcript (Baker *et al.*, 2002; Dubey *et al.*, 2003; Wang *et al.*, 2005). However, in the case of *hfq* the binding of CsrA to the leader does not lead to mRNA destabilization, but to altered transcription (Baker *et al.*, 2007). To test whether CsrA influences *ycdT* and *ydeH* mRNA levels by modulating promoter activity, we constructed plasmid-borne transcriptional *ycdT*- and *ydeH*-*lacZ* fusions, containing the upstream intergenic region and only 2 or 3 nt of each transcript (*ycdT*-547 to +2; *ydeH*-222 to +3). Measuring of β -galactosidase activity of these reporter fusions revealed that both promoters were highly active in the wild type but were not altered by a *csrA* mutation (Fig. 3-4G). In contrast, *lacZ* expression from a control plasmid carrying the *csrB* promoter, which has earlier been reported to be regulated in a CsrA-dependent manner (Gudapaty *et al.*, 2001), was clearly decreased in the *csrA* mutant (Fig. 3-4G). This demonstrates that CsrA does not change transcription of *ycdT* and *ydeH*, but rather modulates the stability of the messages.

YcdT and YdeH regulate motility. Proteins with GGDEF and EAL domains have been demonstrated to be involved in the regulation of bacterial physiology, including motility, biofilm formation, cell morphology and virulence (see reviews by D'Argenio and Miller, 2004; Jenal, 2004; Romling *et al.*, 2005; Romling and Amikam, 2006; Cotter and Stibitz, 2007). To characterize the phenotype of *ycdT* and *ydeH* in motility we analysed the swimming behaviour of strains, in which *ycdT* and *ydeH* were expressed from pBADycdT and pBADydeH respectively, as well as respective knock-out mutants. Overexpression of both pBADycdT and pBADydeH led to a strong repression of swimming behaviour (Fig. 3-5A). The same effect was observed in a *Salmonella*

enterica serovar Typhimurium (*S. Typhimurium*) background, although *S. Typhimurium* do not contain orthologues of these proteins (Fig. 3-5B). Mutations in *ydeH* and *ycdT* led to slightly increased swimming ability compared with the wild type. A *ydeH ycdT* double mutant was, however, not more motile than the wild type (Fig. 3-5C).

Earlier studies have demonstrated that site-directed mutations in the GGDEF signature sequence of other proteins disrupt the function of this domain (Garcia *et al.*, 2004; Paul *et al.*, 2004; Simm *et al.*, 2004). To test whether the repressing effect of *ycdT* and *ydeH* overexpression on motility was due to the activity of both proteins as DGCs, we engineered mutants, in which the two first glycine residues of the respective GGEEF motifs were replaced by two alanine residues (GGEEF→AAEEF). The swimming behaviour of *E. coli* or *Salmonella* expressing the plasmids encoding these mutant YdeH and YcdT variants (pBADycdT-mut, pBADydeH-mut) was indistinguishable from the bacteria carrying the empty vector (Fig. 3-5A and B). This strongly suggests that the effect of YcdT and YdeH on motility is mediated by the second messenger c-di-GMP.

Previous results have demonstrated that a *csrA* mutant is strongly impaired in motility and that CsrA upregulates *flhDC* expression by binding to and stabilizing this mRNA (Wei *et al.*, 2001). To test whether deletions in *ycdT* or *ydeH* can compensate for the swimming defect of the *csrA* mutant we constructed *csrA ycdT* and *csrA ydeH* double mutants as well as a *csrA ycdT ydeH* triple mutant. All three strains were not more motile than the *csrA* mutant (Fig. 3-5D), suggesting complex regulation of motility by pathways within the Csr network.

Beside their impact on motility, many proteins with GGDEF domains have been shown to regulate biofilm formation. In accordance, results of a parallel ongoing study

show that YdeH significantly affects biofilm formation (C. Goller and T. Romeo, unpublished). Furthermore, the effect on biofilm formation seems to be mediated through increased synthesis of the biofilm polysaccharide PGA. YcdT has earlier been characterized regarding its phenotype in biofilm formation (Wang *et al.*, 2005). However, neither biofilm formation nor *pgaA-lacZ* expression was influenced by YcdT under the given conditions (Wang *et al.*, 2005).

In Enterobacteriaceae several GGDEF proteins have been shown to control biofilm formation by regulating the expression of curli fibres (Romling, 2005). Here, we analysed the expression of curli by analysing the colony morphology on Congo Red (CR) agar plates as well as the ability to form pellicles and to adhere to glass culture tubes at the air-liquid interface. However, we were not able to detect distinct *ycdT*- or *ydeH*-dependent phenotypes with respect to CR binding, pellicle formation or glass adherence at the air-liquid interface, suggesting that neither YcdT nor YdeH influences curli production under the conditions tested (data not shown).

Atomic force microscopy analysis of YcdT- and YdeH-mediated phenotypes.

To further investigate the phenotypes mediated by YcdT and YdeH, we employed atomic force microscopy (AFM), a technique recently shown to be a suitable tool for the study of bacterial morphology (Jonas *et al.*, 2007). We allowed the bacteria to grow and to adhere to the substratum mica, which was submerged in the growth medium. For immobilization, the samples were air-dried at room temperature prior to AFM analysis. Images of the wild-type strain carrying pBAD28 showed rod-shaped bacteria expressing flagella and pili-like structures (Fig. 3-6A). Overexpression of pBADydeH resulted in a clear reduction in the abundance of flagella (Fig. 3-6A and B), suggesting a role for

YdeH in the regulation of flagellum biosynthesis. We also noted that YdeH overexpression completely abolished the appearance of the pili-like structures (Fig. 3-6A and C), indicating that flagella and pili synthesis might be co-regulated by YdeH. In contrast to *ydeH*, overexpression of *ycdT* did not affect the occurrence of flagella or pili or another distinct phenotype (Fig. 3-6), indicating that YcdT might have functions in the cell different from YdeH, which cannot be visualized by AFM under the conditions we have tested.

YcdT and YdeH influence c-di-GMP levels *in vivo*. Both YcdT and YdeH contain GGDEF domains with consensus motifs, which are predicted to be dedicated to the synthesis of c-di-GMP (Ausmees *et al.*, 2001; Paul *et al.*, 2004; Simm *et al.*, 2004; Schmidt *et al.*, 2005). So far, proteins with highly conserved active site motifs have been shown to possess DGC activity (Ausmees *et al.*, 2001; Kirillina *et al.*, 2004; Paul *et al.*, 2004; Simm *et al.*, 2004; Weber *et al.*, 2006). In contrast, CsrD with a degenerate motif (HRSDF) failed to produce c-di-GMP (Suzuki *et al.*, 2006). The amino acid sequences of the GGDEF domain of YcdT and YdeH perfectly match the conserved GG(D/E)EF motif as well as additional more extended conserved amino acid signatures of other enzymatically active proteins (Fig. 3-7A). Together with the finding that site-directed mutations of the GGDEF domains of YcdT and YdeH disrupted the effect on motility (Fig. 3-5), this strongly suggests that both proteins synthesize c-di-GMP. To prove this experimentally, we measured the c-di-GMP concentrations produced by *E. coli* MG1655 containing plasmid-encoded *ydeH* (pBADydeH), *ycdT* (pBADycdT) or the empty vector using high-performance liquid chromatography (HPLC) and matrix-assisted laser desorption ionization-time of flight (MALDI-TOF). Expression of *ydeH* resulted in

clearly increased c-di-GMP levels (2215.3 fmol mg⁻¹ cells) compared with the low levels, close to the limit of detection, in the control strain carrying pBAD28 (94.6 fmol mg⁻¹ cells). Even higher levels were detected when *ycdT* was overexpressed (7213.0 fmol mg⁻¹ cells) (Fig. 3-7B). These data provide strong evidence that both of these proteins function as DGC *in vivo*.

The strong effect of CsrA on *ycdT* and *ydeH* transcript levels led us to analyse the overall effect of CsrA on the cellular c-di-GMP pool, by measuring the levels of the second messenger in the wild-type strain MG1655 and its *csrA* mutant. We were able to consistently detect slightly elevated c-di-GMP levels in the *csrA* mutant (120.8 fmol mg⁻¹ cells) compared with the wild type (74.5 fmol mg⁻¹ cells) (Fig. 3-7C). This finding demonstrates a net effect of CsrA in the regulation of c-di-GMP turnover and is consistent with the previously documented negative effect of CsrA on biofilm formation (Jackson *et al.*, 2002).

Several genes encoding GGDEF and EAL proteins have previously been shown to cross-complement phenotypes (Garcia *et al.*, 2004; Simm *et al.*, 2004), even between different species (Simm *et al.*, 2005). In *Salmonella*, a mutation in the GGDEF gene *adrA* results in deficiency in cellulose synthesis due to decreased c-di-GMP levels.

Overexpression of enzymatically active GGDEF proteins in such a *Salmonella* mutant leads to the restoration of cellulose production, which can be visualized on agar plates containing the dyes calcofluor (CF) or CR. Thus, the ability to produce cellulose can be used as an indicator for DGC activity. We utilized this effect to study the enzymatic activities of YcdT and YdeH in *S. Typhimurium*. Strain MAE103, mutated in *adrA* and carrying pBAD_{ycdT}, pBAD_{ydeH} or the controls pBAD28 or pBAD_{csrA}, was allowed to

grow on CF and CR agar plates at 28°C. Overexpression of pBADydeH resulted in a strongly fluorescent colony appearance of *Salmonella* on the CF plates (Fig. 3-7D) and as pink and rough colonies on the CR plates (data not shown), suggesting that cellulose was produced due to the elevated production of c-di-GMP. However, no dye binding could be observed for the strain carrying pBADycdT, demonstrating that *ycdT* fails to cross-complement an *adrA* mutation in *Salmonella* under the given conditions. In agreement with these data, only subtle changes (less than twofold) in c-di-GMP levels were observed by HPLC and MALDI-TOF, when *ycdT* was overexpressed in *Salmonella*, grown at 28°C on Luria–Bertani (LB) agar without salt, whereas plasmid-encoded expression of *ydeH* in the same background strain resulted in strongly elevated c-di-GMP levels (> 200-fold) (Fig. 3-7E). Thus, in contrast to YdeH, which apparently possesses high DGC activity in plate-grown *Salmonella* at 28°C, YcdT appears to produce c-di-GMP at very low concentrations under the given conditions. A previous study has already demonstrated that in *Salmonella* most, but not all, GGDEF proteins with conserved sequence signatures could restore cellulose production in an *adrA* mutant (Garcia *et al.*, 2004) and that the cross-complementation ability strongly depended on the experimental conditions.

Global role of CsrA in the regulation of other GGDEF/EAL proteins. To test whether CsrA controls the expression of additional GGDEF/EAL proteins we analysed our array data for the expression patterns of all genes, annotated to contain a GGDEF and/or EAL domain, 4 and 12 min after CsrA pulse overproduction. For 4 of the 29 selected genes the signals were too low for reliable detection on the microarray (*yeaI*, *yaiC*, *yhjH* and *ycgG*). Most of the other GGDEF/EAL genes were relatively weakly

expressed, but strongly enough for detection on the array. Interestingly, beside *ycdT* and *ydeH* several other genes showed changes in their transcript levels upon CsrA overproduction with an additive effect between 4 and 12 min: *yddV* (GGDEF), *yliF* (GGDEF), *dos* (GGDEF-EAL), *yhjK* (GGDEF-EAL), *csrD* (GGDEF-EAL), *yliE* (EAL) and *yjcC* (EAL) (Fig. 3-8A and E). CsrA-dependent repression of these genes was, however, not as strong (1.5–2.5 fold) as repression of *ycdT* and *ydeH*. RT-PCR analysis of the kinetics of CsrA-dependent expression confirmed that mRNA levels of *yliE*, *yliF*, *yddV*, *dos* and *csrD* were indeed downregulated upon induction of pBAD_{CsrA} (Fig. 3-8B), but remained constant or increased upon induction of the vector control (Fig. 3-8C). In the *csrA* mutant strain, expression of these genes was moderately increased (between two- and sixfold) compared with the wild type (Fig. 3-8D). Repression of *yhjK* and *yjcC* by CsrA overproduction could not be confirmed (data not shown). Noticeably, *yddV* and *dos* (Mendez-Ortiz *et al.*, 2006) as well as *yliE* and *yliF* are organized as polycistronic units in operons (Fig. 3-8F and G). The expression patterns of *yliE* and *yliF* as well as *yddV* and *dos* followed almost identical kinetics (Fig. 3-8B and C), indicating that these genes are co-regulated at the mRNA level by CsrA. The observation that CsrD is negatively regulated by CsrA agrees with the earlier finding that expression of a chromosomal *csrD-lacZ* translational fusion was modestly repressed (twofold) by CsrA (Suzuki *et al.*, 2006). These data confirm that CsrD is part of an additional autoregulatory loop within the Csr system. In summary, our data demonstrate that beside *ycdT* and *ydeH*, genes for several other GGDEF and GGDEF-EAL proteins as well as one EAL protein are negatively regulated by CsrA. This finding suggests a global role for CsrA in the regulation of c-di-GMP metabolism.

DISCUSSION

Post-transcriptional regulation of GGDEF/EAL proteins by CsrA. The present study was initiated with a genome-wide search for novel targets for the post-transcriptional regulator CsrA to better understand its role in bacterial adaptation and the cross-talk between the Csr system and other regulatory systems. Our search led to the finding that CsrA controls the expression of several GGDEF/EAL proteins, in particular the GGDEF proteins YcdT and YdeH, by physically binding to and changing their mRNA levels. To our knowledge this is the first example of GGDEF/EAL proteins being regulated at the mRNA level by a global post-transcriptional regulator. This supports the idea that c-di-GMP signalling is a multilayer process, including transcriptional, translational and post-translational levels. The array data also indicated that CsrA controls other mRNAs, some of them with unknown functions, but these effects need to be confirmed and were not the focus of this study.

With binding constants (K_d) of approximately 2.5 nM, CsrA binding to the *ycdT* and *ydeH* transcripts was remarkably strong. The affinities to the other known mRNA targets *pgaA*, *glgC*, *cstA* and *hfq* were approximately 10-fold lower (22, 39, 40 and 38 nM respectively) (Baker *et al.*, 2002; 2007; Dubey *et al.*, 2003; Wang *et al.*, 2005). Noteworthy, for each of the *ycdT* and *ydeH* transcripts only two GGA boxes were found in the 5' leader sequences and binding of two CsrA proteins per transcript was observed at higher concentrations. For comparison, *pgaA*, *glgC* and *cstA* contain four to six potential CsrA binding sites. Moreover, in the case of *ycdT*, the sequence signature of both sites showed relative poor similarity to the consensus sequence. Thus, in addition to

the primary sequence conservations, other determinants seem to largely influence the affinity of CsrA to its targets.

Our array revealed that beside YcdT and YdeH, two additional GGDEF proteins (YddV, YliF), two GGDEF-EAL proteins (Dos, CsrD) and one EAL protein (YliE) were regulated by CsrA. Together with the finding that increased overall levels of cellular c-di-GMP were measured in a *csrA* mutant, this implicates a global role for CsrA in the regulation of c-di-GMP metabolism. It is plausible that under other experimental conditions CsrA might control the expression of additional GGDEF/EAL proteins. For most of the GGDEF/EAL genes, relatively weak signals were detected on the microarray, suggesting that these genes require specific conditions for enhanced expression, different from the standard conditions used in our experiment. As CsrA homologues are present in many different Gram-negative bacteria (White *et al.*, 1996) the role of CsrA in the regulation of GGDEF/EAL proteins might be a conserved feature. With the exception of CsrD, no other of the CsrA-regulated GGDEF/EAL genes have homologous genes in *S. Typhimurium*. Therefore, CsrA might act on other GGDEF/EAL proteins in other bacteria. Furthermore, we cannot exclude that our microarray approach, which requires the destabilization of the CsrA mRNA targets upon its binding, failed to identify other important CsrA targets, in which translation is regulated without a corresponding alteration in mRNA stability, similar to the previous findings for *hfq* (Baker *et al.*, 2007).

Interplay between Csr and c-di-GMP signaling. While c-di-GMP-mediated phenotypes and the molecular mechanisms governing c-di-GMP synthesis and turnover have received much attention, the role of the c-di-GMP network in signal transduction, including its linkage to external signals of specific adaptive responses and its

interconnection with other global networks, is relatively unexplored. Nevertheless, in *E. coli* genes encoding GGDEF/EAL domains were recently reported to be overrepresented in the σ^S (RpoS) regulon, suggesting a role for c-di-GMP during the general stress response (Weber *et al.*, 2006). In *Vibrio cholerae* quorum-sensing signalling was recently demonstrated to be connected to c-di-GMP signalling through the action of the major quorum-sensing regulator HapR (Waters *et al.*, 2008). Furthermore, some GGDEF/EAL proteins, exemplified by the response regulator PleD (Aldridge and Jenal, 1999), contain phospho-receiver domains or other signalling domains, facilitating cross-talk and the integration into other signal cascades (Paul *et al.*, 2008).

Our study revealed a direct link between the global Csr network and c-di-GMP signalling, placing both pathways in a broad cellular context. CsrA activity is controlled by the sRNAs CsrB and CsrC, whose expression levels are regulated by the BarA-UvrY two-component system and the probable inner membrane protein CsrD (Fig. 3-9). CsrA has previously been shown to control motility and biofilm formation by directly targeting the *flhDC* and *pgaA* mRNAs respectively. Here, we show that in addition to the regulation of biosynthesis and global regulators CsrA regulates bacterial physiology in a c-di-GMP-dependent pathway by directly controlling the expression of *ycdT* and *ydeH*, which cause c-di-GMP accumulation and thereby favour the sessile life style. The combination of c-di-GMP-dependent and c-di-GMP-independent regulatory pathways allows CsrA to regulate biofilm-related processes at various levels and thus to trigger the switch between a motile and a sessile life style. The CsrA- and c-di-GMP-specific adaptive responses are controlled by environmental signals, integrated at multiple sites within the signalling cascade. Although the nature of the signal sensed by BarA is not

known, it is proposed to reflect the energy/growth status of the cell (Pernestig *et al.*, 2003). In addition, BarA-UvrY signalling was recently demonstrated to be pH-dependent (Mondragon *et al.*, 2006). The prediction that CsrD and YcdT are membrane-bound suggests that their activity is controlled from the outside. In addition, transcription of *ydeH* was previously demonstrated to depend on the CpxAR two-component system, responding to cell envelope stress and external copper (Yamamoto and Ishihama, 2005; 2006). A future challenge will be the identification of the nature of different input signals controlling Csr and c-di-GMP signalling.

The roles of YcdT and YdeH in bacterial physiology. Numerous studies have shown that c-di-GMP controls bacterial behaviour (reviews by D'Argenio and Miller, 2004; Jenal, 2004; Romling, 2005; Romling and Amikam, 2006). High levels of this second messenger favour sessility whereas low levels of c-di-GMP promote a motile life style. In accordance, YdeH and YcdT were found to repress swimming behaviour. YdeH seems to act at the level of flagellum synthesis while YcdT seems to modulate flagella function, raising the possibility that individual GGDEF proteins are dedicated to specific functions in the cell. We also observed that in the strain overexpressing YdeH the occurrence of pili was abolished. A recent study proposed a link between c-di-GMP signalling and type 1 pili and flagella expression in the Crohn disease-associated adherent-invasive *E. coli* strain LF82 (Claret *et al.*, 2007). While similar pathways might exist in *E. coli* K12, to this date we have no evidence for this hypothesis.

Our data show that overexpression of *ydeH* led to highly elevated c-di-GMP levels and pronounced cellulose production in *Salmonella*. Consistent with these data, results from another parallel study suggest a significant role for YdeH in biofilm formation by

regulating PGA synthesis (C. Goller and T. Romeo, unpublished). Although overexpression of *ycdT* resulted in a strong accumulation of cellular c-di-GMP, we did not observe a distinct biofilm-related phenotype neither in *E. coli* nor in *S. Typhimurium*. In addition, in an earlier study biofilm formation and *pgaA-lacZ* expression were not affected in the *ycdT* mutant XWVGΔT (Wang *et al.*, 2005). Nevertheless, we suspect that not only YdeH, but also YcdT might have an impact on biofilm formation under other experimental growth conditions. The *ycdT* gene and the *pga* operon are divergently organized (Fig. 3-1E). A comprehensive bioinformatics study has recently demonstrated that chromosomal proximity indicates gene co-regulation in prokaryotes independent of relative gene orientation and that adjacent bidirectionally transcribed genes with conserved gene orientation are strongly co-regulated (Korbel *et al.*, 2004). Furthermore, the *ycdT* homologue in *Yersinia pestis*, called HmsT, has been reported to be required for biofilm formation (Kirillina *et al.*, 2004). Likewise, there is evidence that *E. coli* and *Y. pestis* produce the PGA polysaccharide as biofilm matrix component (Itoh *et al.*, 2005; Bobrov *et al.*, 2008). Synthesis of this polysaccharide was in a recent study shown to be positively regulated by HmsT, which was suggested to control c-di-GMP levels in close proximity to the glycosyltransferase HmsR, responsible for the production of the polysaccharide (Bobrov *et al.*, 2008). Thus, regulation of PGA synthesis in *Yersinia* seems to occur in a c-di-GMP-dependent fashion, similar to the production of the biofilm polysaccharide cellulose in *Salmonella*. Moreover, another recent study showed that synthesis of the PEL polysaccharide in *Pseudomonas aeruginosa* is regulated by c-di-GMP. Here, the PelD protein serves as the c-di-GMP receptor, activating the production of the PEL polysaccharide by a yet to be defined mechanism (Lee *et al.*, 2007). These

data suggest that there are related c-di-GMP-dependent processes for controlling synthesis of the PGA exopolysaccharide in *E. coli*.

Noticeably, the *pel* genes in *Pseudomonas*, necessary for PEL synthesis, have been suggested to be regulated by the GacS-GacA-Rsm cascade, which is homologous to the BarA-UvrY-Csr pathway in *E. coli* (Goodman *et al.*, 2004), further suggesting that the role of the Csr regulatory network in the regulation of biofilm components may be a conserved feature among γ -proteobacteria.

MATERIALS AND METHODS

Bacterial strains and growth conditions. All strains used in this study are listed in Table 3-1. Chromosomal *ydeH::cat* and *csrB::cat* mutations were constructed using the Datsenko method (Datsenko and Wanner, 2000). The *cat* gene was amplified from pKD3 by PCR using primers *ydeHKOfor2* and *ydeHKORev2* or *csrBKOfor* and *csrBKORev* (Table 3-2) respectively, and introduced by electroporation into arabinose-treated BW25141 carrying pKD46. Transformants were selected on chloramphenicol plates, and their insertion sites were confirmed by PCR using the primer pairs *ydeHKOfor2/ydeHKORev2* and *csrBKOfor/csrBKORev* (Table 3-2). Mutations were transferred among strains by P1 transduction. For construction of the *csrB csrC* double mutant KJ230, the *csrC::tet* allele from strain TWMG1655 was moved into the *csrB* mutant KJ227, from which the chloramphenicol cassette had been flipped out using the FLP recombinase. Strain KJ311 was generated by removing the chloramphenicol cassette from KJ295 by using the FLP recombinase and subsequent infection with a P1 lysate containing the *ycdT::cat* mutation from XWMG Δ T. For

construction of strain KJ157, *csrA::kan^r* was moved from TRMG into KSB837. To generate the *csrD* mutant KJ205 the *yhdA::cat^r* cassette from KJ27 was transduced into MG1655. To generate KJ331, KJ330 and KJ369, *csrA::kan^r* was transduced from TRMG into KJ295, XWMGΔT or KJ311 respectively. In most of the experiments, bacteria were grown in LB medium at 37°C with shaking at 200 r.p.m. If necessary, antibiotics were added: ampicillin 100 μg ml⁻¹, kanamycin 50 μg ml⁻¹ and chloramphenicol 30 μg ml⁻¹.

Plasmid construction. All plasmids used in this study are listed in Table 3-1. For construction of pBAD*csrA*, pBAD*ydeH* and pBAD*ycdT*, the genes for *csrA*, *ydeH* and *ycdT* were amplified from the MG1655 chromosome by PCR using the primer pairs CsrAForBAD/CsrARevBAD, pBAD*ydeH*For/pBAD*ydeH*Rev or pBAD*ycdT*For2/pBAD*ycdT*Rev2 respectively (Table 3-2). The PCR products of *csrA* and *ydeH* were cleaved with the enzymes HindIII and XbaI, while the product of *ycdT* was cut with SacI and XbaI. After cleavage of the pBAD28 vector at the corresponding sites followed by dephosphorylation (Shrimp Alkaline Phosphatase, Roche Diagnostics), the cleaved PCR fragments were inserted using the Rapid DNA Ligation Kit (Roche Diagnostics). For construction of pPYCDT and pPYDEH the upstream intergenic regions of the *ycdT* gene and the *ydeH* gene, including 2 or 3 nt of the respective transcripts (*ycdT*-547 to +2; *ydeH*-222 to +3) were amplified using the primer pairs PycdTFor-EcoRI/PycdTRev-BamHI or PydeHFor-EcoRI/PydeHRev-BamHI (Table 3-2) respectively, and subsequently digested by BamHI and EcoRI. After removing the *PcsrB* insert from vector pCBZ1 (Gudapaty *et al.*, 2001) by BamHI and EcoRI cleavage, the empty linearized vector was dephosphorylated and ligated with the respective *ycdT* or

ydeH fragments to create pPYCDT and pPYDEH. Sequencing verified the integrity of all plasmid constructs.

Site-directed mutagenesis. To engineer the mutated *ycdT* and *ydeH* alleles, plasmids pBADycdT and pBADydeH were subjected to site-directed mutagenesis using the high-performance liquid chromatography-purified primer pairs YcdT-Mut-For/YcdT-Mut-Rev and YdeH-Mut-For/YdeH-Mut-Rev (Table 3-2) and the QuikChange II site-directed mutagenesis kit (Stratagene) to create plasmids pBADycdT-mut and pBADydeH-mut. Mutations introduced into *ycdT* and *ydeH* led to the replacement of the two glycines at positions 359 and 360 (*ycdT*) or 206 and 207 (*ydeH*) in the GGEEF motif by alanine (YcdT G359A, G360A; YdeH G206A, G207A). The mutations were confirmed by sequencing.

RNA extraction. Bacterial cultures were mixed with 2 vols of RNAprotect Bacterial Reagent (Qiagen) and incubated for 5 min at room temperature. Total cellular RNA was subsequently prepared by using the RNeasy Mini Kit with on-column DNA digestion (Qiagen). RNA concentrations were determined using the NanoDrop ND-1000 UV-Vis Spectrophotometer (NanoDrop Technologies, Wilmington, DE). The quality of the RNA used for the microarray was assessed using the Agilent Bioanalyser.

Microarray analysis. Microarray analysis was performed at the Bioinformatics and Expression Analysis Core Facility at the Karolinska Institute (<http://www.bea.ki.se>) using the GeneChip *E. coli* Genome 2.0 Array (Affymetrix, P/N 900551, Santa Clara, CA). This array includes approximately 10 000 probe sets for all 20 366 genes present in four strains of *E. coli*. Affymetrix analysis was conducted according to the Affymetrix manual (<http://www.affymetrix.com>). The absolute signals from the samples, taken at

0 min (before arabinose induction), were compared with the signals from the 4 and 12 min samples. The signal ratios resulting from pBADcsrA overexpression were then normalized with the ratios resulting from overexpression of the empty vector pBAD28. Genes, whose expression levels were too low for reliable detection, or whose expression levels were decreased in response to induction of the empty vector pBAD28, were excluded from the analysis.

Quantitative real-time RT-PCR. Five hundred nanograms of total RNA was used to synthesize cDNA using the High-Capacity cDNA Reverse Transcription Kit (Applied Biosystems). Primers were designed using the Primer Express Software v3.0 (Applied Biosystems). All RT primers used in this study are listed in Table 3-2. 0.1 ng template was used for the real-time PCR reaction using the Power SYBR Green PCR Master Mix (Applied Biosystems). Analysis was performed with an ABI 7500 Real Time PCR System (Applied Biosystems) using the standard run mode of the instrument. For detection of primer dimerization or other artefacts of amplification, a dissociation curve was run immediately after completion of the real-time PCR. Individual gene expression profiles were normalized against the *rrnD* gene, serving as an endogenous control. All results were analysed using the 7500 SDS Software v1.3.1 (Applied Biosystems) and further prepared using Excel (Microsoft). The data values presented in all figures represent the mean expression level of quadruplicates from one real-time PCR assay, relative to a calibrator value (time point 0 min or wild type). The error bars represent the standard error of the mean expression level calculated by the SDS software using the confidence value 95%. Each experiment was repeated independently and representative data were chosen for presentation.

5' RACE. 5' ends of the *ycdT* transcripts were determined using the 5' RACE System for Rapid Amplification of cDNA Ends (v2.0, Invitrogen). Three micrograms of total RNA was reverse-transcribed using the primer YcdTGSP1 and the superscript II RT. cDNAs were purified, C-tailed with a terminal deoxynucleotidyl transferase and used as template in a PCR with an anchor primer (AAP), specific for the C-tail, and the gene specific primer YcdTGSP2HindIII (GSP2), complementary to a region upstream of the binding site of GSP1. To increase specificity, a nested PCR was carried out using the nested anchor primer UAP and the gene-specific nested primer YcdTGSP3HindIII (GSP3). The PCR products were visualized on a 2% agarose gel in TBE buffer and subsequently sequenced using the Big Dye Terminator Cycle Sequencing Kit (v3.1).

RNA gel mobility shift assays. Quantitative gel mobility shift assays followed a previously published procedure (Yakhnin *et al.*, 2000). *E. coli* CsrA-His₆ protein was purified as described previously (Mercante *et al.*, 2006). DNA templates for generating *ycdT* and *ydeH* RNA transcripts were produced by annealing primers ycdT-T7 (-36 to +20) and GC ycdT-T7 (-36 to +20) and ydeH-T7 (-29 to +25) and GC ydeH-T7 (-29 to +25) in TES buffer (10 mM Tris-HCl pH 8.0, 1 mM EDTA, 100 mM NaCl). RNA was synthesized *in vitro* using the MEGAscript kit (Ambion) using the annealed DNA primers (for *ydeH* and *ycdT*) or linearized plasmid pPB77 (Babitzke *et al.*, 1994) as templates. After gel purification, transcripts were 5' end-labelled using T4 polynucleotide kinase and [γ -³²P]-ATP. Radiolabelled RNA was gel-purified and re-suspended in TE (10 mM Tris-HCl pH 8.0, 1 mM EDTA), heated to 85°C and chilled on ice. Increasing concentrations of purified CsrA-His₆ recombinant protein were combined with 80 pM radiolabelled RNA in 10 μ l of binding reactions [10 mM Tris-HCl pH 7.5, 10 mM

MgCl₂, 100 mM KCl, 3.25 ng total yeast RNA, 20 mM DTT, 7.5% glycerol, 4 U SUPERasin (Ambion, Austin, TX)] for 30 min at 37°C to allow for CsrA–RNA complex formation. Competition assays were performed in the absence or presence of unlabelled RNA specific and non-specific competitors. Binding reactions were separated using 12% native polyacrylamide gels, and radioactive bands were visualized with a Molecular Dynamics phosphorimager. Free and bound RNA species were quantified with ImageQuant Software (Molecular Dynamics), and an apparent equilibrium binding constant (K_d) was calculated for CsrA–RNA complex formation according to a previously described cooperative binding equation (Mercante *et al.*, 2006). The mean values and standard errors from two independent experiments were determined for each transcript. Graphpad Prism version 3.02 for Windows (San Diego, CA) software was used for calculations.

β-Galactosidase assay. β-galactosidase activity was measured in 10 min reactions using the Miller protocol (1972). Twenty microlitres of bacterial culture, grown to an OD₆₀₀ of 1.5, was used for each reaction. Each measurement was carried out independently at least two times.

Quantification of c-di-GMP. Nucleotide extracts were prepared essentially as previously described (Simm *et al.*, 2004). For c-di-GMP extraction from liquid cultures, bacteria were grown in LB medium to OD₆₀₀ 1.5 at 37°C, treated with formaldehyde (0.19% final concentration) and pelleted by centrifugation. The pellet was re-suspended in ice-cold water, heated to 95°C for 10 min, before nucleotides were extracted by ethanol treatment. For c-di-GMP extraction from plate-grown bacteria, approximately 100 mg of cells was harvested and immediately suspended in ice-cold 0.19%

formaldehyde, before being boiled for 10 min and treated with ethanol. Nucleotide extracts of 10 or 50 mg of cells (wet weight) were fractioned by HPLC using a reversed-phase column (Hypersil ODS 5 μ ; Hypersil-Keystone). Runs were carried out with a multistep gradient using 0.1 M triethyl ammonium acetate (pH 6.0) at 1 ml min⁻¹ with increasing concentrations of acetonitrile. Relevant fractions were collected, lyophilized and re-suspended in 10 μ l of water. Fractions containing c-di-GMP were pinpointed by MALDI-TOF analysis and pooled. Synthetic c-di-AMP was added to the pooled fractions at a suitable concentration to be used as an internal standard. A standard curve was established using fractions spiked with known amounts of c-di-GMP, using a fixed amount of synthetic c-di-AMP as internal control. The isotope areas of c-di-GMP and c-di-AMP were calculated, and the ratio was determined. Each c-di-GMP measurement was carried out independently at least two times.

AFM microscopy. Sample preparation and AFM imaging were performed as earlier described (Jonas *et al.*, 2007). Bacteria were allowed to grow for 24 h at 28°C on mica slides Grade V-4 (SPI Supplies, USA) submerged in Petri dishes containing 3 ml of LB medium without NaCl. After incubation the mica slides were dipped three to four times into double-distilled water, air-dried at room temperature in a dust-free environment for several hours and mounted onto glass microscope slides. Bacteria were imaged with the BioScope SZ (Veeco Instruments, Woodbury, NJ) operated in the contact mode using V-shaped silicon nitride nanoprobe cantilevers MLCT-AUHW (Veeco) with a spring constant of 0.05 N m⁻¹. Images were captured using NanoScope v6.13 (Veeco) and further analysed with the scanning probe software WSxM (Nanotec Electronica, Spain) (Horcas *et al.*, 2007). To quantify flagella expression, the number of

flagella and the number of bacteria were counted at five different locations on the microscope slide for each strain. The ratio of flagella per 10 bacteria was calculated and the mean and the standard deviation determined. To quantify pili expression, the number of bacteria expressing pili per total number of bacteria was calculated at five different locations for each strain, from which the mean value and the standard deviation were calculated.

Phenotypic assays. To analyse the swimming behaviour of the bacteria, 0.3% motility agar plates, if necessary supplemented with 0.1% arabinose, were inoculated with 4 μl of overnight culture and incubated at 37°C. The diameter of the swimming zone was measured over time. For analysis of colony morphology, bacteria from an overnight culture were streaked onto LB agar plates with or without NaCl supplemented with CR (40 $\mu\text{g ml}^{-1}$) and Coomassie brilliant blue (20 $\mu\text{g ml}^{-1}$) or CF (fluorescence brightener 28; 50 $\mu\text{g ml}^{-1}$). Plates were incubated at 28°C or 37°C for 20 h or 24 h respectively. The colony morphology and dye binding were analysed over time. Glass adherence was measured by culturing the bacteria in standing glass culture tubes containing LB medium with or without salt at 28°C or 37°C for 24 h. After analysing the formation of pellicles visually, the culture liquid was discarded by decanting and the bacteria, adherent to the glass tubes, were stained with crystal violet solution. The tubes were subsequently rinsed with water, allowed to air-dry in the upside-down position and adherence of the bacteria to the glass was analysed visually.

Bioinformatic analysis. The protein domain structures were analysed using Pfam (<http://www.sanger.ac.uk>) and UniProt (<http://beta.uniprot.org/>) and aligned using

CLUSTALW (<http://www.ebi.ac.uk>). The genomic context of the genes was analysed using EcoCyc (<http://www.ecocyc.org>).

ACKNOWLEDGEMENTS

We thank Dr Jörg Vogel for helpful discussions and the Bioinformatics and Expression Analysis Core Facility at the Karolinska Institute for carrying out the microarray experiment. This work was supported by a grant from the Marie Curie Early Stage Research Training Fellowship of the European Community's Sixth Framework Program under Contract Number MEST-CT-2004-8475 and by National Institutes of Health grants to T.R. (GM059969, GM066794).

REFERENCES

- Aldridge, P., and Jenal, U. (1999) Cell cycle-dependent degradation of a flagellar motor component requires a novel-type response regulator. *Mol Microbiol* **32**: 379–391.
- Altier, C., Suyemoto, M., and Lawhon, S.D. (2000) Regulation of *Salmonella enterica* serovar typhimurium invasion genes by *csrA*. *Infect Immun* **68**: 6790–6797.
- Ausmees, N., Mayer, R., Weinhouse, H., Volman, G., Amikam, D., Benziman, M., and Lindberg, M. (2001) Genetic data indicate that proteins containing the GGDEF domain possess diguanylate cyclase activity. *FEMS Microbiol Lett* **204**: 163–167.
- Babitzke, P., and Romeo, T. (2007) CsrB sRNA family: sequestration of RNA-binding regulatory proteins. *Curr Opin Microbiol* **10**: 156–163.
- Babitzke, P., Stults, J.T., Shire, S.J., and Yanofsky, C. (1994) TRAP, the *trp* RNA-binding attenuation protein of *Bacillus subtilis*, is a multisubunit complex that

- appears to recognize G/UAG repeats in the trpEDCFBA and trpG transcripts. *J Biol Chem* **269**: 16597–16604.
- Baker, C.S., Morozov, I., Suzuki, K., Romeo, T., and Babitzke, P. (2002) CsrA regulates glycogen biosynthesis by preventing translation of glgC in *Escherichia coli*. *Mol Microbiol* **44**: 1599–1610.
- Baker, C.S., Eory, L.A., Yakhnin, H., Mercante, J., Romeo, T., and Babitzke, P. (2007) CsrA inhibits translation initiation of *Escherichia coli* hfq by binding to a single site overlapping the Shine-Dalgarno sequence. *J Bacteriol* **189**: 5472–5481.
- Barnard, F.M., Loughlin, M.F., Fainberg, H.P., Messenger, M.P., Ussery, D.W., Williams, P., and Jenks, P.J. (2004) Global regulation of virulence and the stress response by CsrA in the highly adapted human gastric pathogen *Helicobacter pylori*. *Mol Microbiol* **51**: 15–32.
- Bobrov, A.G., Kirillina, O., Forman, S., Mack, D., and Perry, R.D. (2008) Insights into *Yersinia pestis* biofilm development: topology and co interaction of Hms inner membrane proteins involved in exopolysaccharide production. *Environ Microbiol* **10**: 1419–1432.
- Chan, C., Paul, R., Samoray, D., Amiot, N.C., Giese, B., Jenal, U., and Schirmer, T. (2004) Structural basis of activity and allosteric control of diguanylate cyclase. *Proc Natl Acad Sci USA* **101**: 17084–17089.
- Claret, L., Miquel, S., Vieille, N., Ryjenkov, D.A., Gomelsky, M., and Darfeuille-Michaud, A. (2007) The flagellar sigma factor FliA regulates adhesion and invasion of Crohn disease-associated *Escherichia coli* via a cyclic dimeric GMP-dependent pathway. *J Biol Chem* **282**: 33275–33283.

- Cotter, P.A., and Stibitz, S. (2007) c-di-GMP-mediated regulation of virulence and biofilm formation. *Curr Opin Microbiol* **10**: 17–23.
- D'Argenio, D.A., and Miller, S.I. (2004) Cyclic di-GMP as a bacterial second messenger. *Microbiology* **150**: 2497–2502.
- Datsenko, K.A., and Wanner, B.L. (2000) One-step inactivation of chromosomal genes in *Escherichia coli* K-12 using PCR products. *Proc Natl Acad Sci USA* **97**: 6640–6645.
- Dubey, A.K., Baker, C.S., Suzuki, K., Jones, A.D., Pandit, P., Romeo, T., and Babitzke, P. (2003) CsrA regulates translation of the *Escherichia coli* carbon starvation gene, *cstA*, by blocking ribosome access to the *cstA* transcript. *J Bacteriol* **185**: 4450–4460.
- Dubey, A.K., Baker, C.S., Romeo, T., and Babitzke, P. (2005) RNA sequence and secondary structure participate in high-affinity CsrA–RNA interaction. *RNA* **11**: 1579–1587.
- Garcia, B., Latasa, C., Solano, C., Garcia-del Portillo, F., Gamazo, C., and Lasa, I. (2004) Role of the GGDEF protein family in *Salmonella* cellulose biosynthesis and biofilm formation. *Mol Microbiol* **54**: 264–277.
- Goodman, A.L., Kulasekara, B., Rietsch, A., Boyd, D., Smith, R.S., and Lory, S. (2004) A signaling network reciprocally regulates genes associated with acute infection and chronic persistence in *Pseudomonas aeruginosa*. *Dev Cell* **7**: 745–754.
- Gudapaty, S., Suzuki, K., Wang, X., Babitzke, P., and Romeo, T. (2001) Regulatory interactions of Csr components: the RNA binding protein CsrA activates *csrB* transcription in *Escherichia coli*. *J Bacteriol* **183**: 6017–6027.

- Guzman, L.M., Belin, D., Carson, M.J., and Beckwith, J. (1995) Tight regulation, modulation, and high-level expression by vectors containing the arabinose PBAD promoter. *J Bacteriol* **177**: 4121–4130.
- Hawley, D.K., and McClure, W.R. (1983) Compilation and analysis of *Escherichia coli* promoter DNA sequences. *Nucleic Acids Res* **11**: 2237–2255.
- Heeb, S., and Haas, D. (2001) Regulatory roles of the GacS/GacA two-component system in plant-associated and other gram-negative bacteria. *Mol Plant Microbe Interact* **14**: 1351–1363.
- Heeb, S., Valverde, C., Gigot-Bonnefoy, C., and Haas, D. (2005) Role of the stress sigma factor RpoS in GacA/RsmA-controlled secondary metabolism and resistance to oxidative stress in *Pseudomonas fluorescens* CHA0. *FEMS Microbiol Lett* **243**: 251–258.
- Heurlier, K., Williams, F., Heeb, S., Dormond, C., Pessi, G., Singer, D., *et al.* (2004) Positive control of swarming, rhamnolipid synthesis, and lipase production by the posttranscriptional RsmA/RsmZ system in *Pseudomonas aeruginosa* PAO1. *J Bacteriol* **186**: 2936–2945.
- Horcas, I., Fernandez, R., Gomez-Rodriguez, J.M., Colchero, J., Gomez-Herrero, J., and Baro, A.M. (2007) WSXM: a software for scanning probe microscopy and a tool for nanotechnology. *Rev Sci Instrum* **78**: 013705.
- Itoh, Y., Wang, X., Hinnebusch, B.J., Preston, J.F., Romeo, T. (2005) Depolymerization of beta-1,6-N-acetyl-D-glucosamine disrupts the integrity of diverse bacterial biofilms. *J Bacteriol* **187**: 382–387.

- Jackson, D.W., Suzuki, K., Oakford, L., Simecka, J.W., Hart, M.E., and Romeo, T. (2002) Biofilm formation and dispersal under the influence of the global regulator CsrA of *Escherichia coli*. *J Bacteriol* **184**: 290–301.
- Jenal, U. (2004) Cyclic di-guanosine-monophosphate comes of age: a novel secondary messenger involved in modulating cell surface structures in bacteria? *Curr Opin Microbiol* **7**: 185–191.
- Jonas, K., Tomenius, H., Romling, U., Georgellis, D., and Melefors, O. (2006) Identification of YhdA as a regulator of the *Escherichia coli* carbon storage regulation system. *FEMS Microbiol Lett* **264**: 232–237.
- Jonas, K., Tomenius, H., Kader, A., Normark, S., Romling, U., Belova, L.M., and Melefors, O. (2007) Roles of curli, cellulose and BapA in *Salmonella* biofilm morphology studied by atomic force microscopy. *BMC Microbiol* **7**: 70.
- Kay, E., Dubuis, C., and Haas, D. (2005) Three small RNAs jointly ensure secondary metabolism and biocontrol in *Pseudomonas fluorescens* CHA0. *Proc Natl Acad Sci USA* **102**: 17136–17141.
- Kirillina, O., Fetherston, J.D., Bobrov, A.G., Abney, J., and Perry, R.D. (2004) HmsP, a putative phosphodiesterase, and HmsT, a putative diguanylate cyclase, control Hms-dependent biofilm formation in *Yersinia pestis*. *Mol Microbiol* **54**: 75–88.
- Korbel, J.O., Jensen, L.J., von Mering, C., and Bork, P. (2004) Analysis of genomic context: prediction of functional associations from conserved bidirectionally transcribed gene pairs. *Nat Biotechnol* **22**: 911–917.

- Lee, V.T., Matewish, J.M., Kessler, J.L., Hyodo, M., Hayakawa, Y., and Lory, S. (2007) A cyclic-di-GMP receptor required for bacterial exopolysaccharide production. *Mol Microbiol* **65**: 1474–1484.
- Lenz, D.H., Miller, M.B., Zhu, J., Kulkarni, R.V., and Bassler, B.L. (2005) CsrA and three redundant small RNAs regulate quorum sensing in *Vibrio cholerae*. *Mol Microbiol* **58**: 1186–1202.
- Liu, M.Y., and Romeo, T. (1997) The global regulator CsrA of *Escherichia coli* is a specific mRNA-binding protein. *J Bacteriol* **179**: 4639–4642.
- Liu, M.Y., Gui, G., Wei, B., Preston, J.F., Oakford, L., Yuksel, U., *et al.* (1997) The RNA molecule CsrB binds to the global regulatory protein CsrA and antagonizes its activity in *Escherichia coli*. *J Biol Chem* **272**: 17502–17510.
- Lucchetti-Miganeh, C., Burrowes, E., Baysse, C., and Ermel, G. (2008) The post-transcriptional regulator CsrA plays a central role in the adaptation of bacterial pathogens to different stages of infection in animal hosts. *Microbiology* **154**: 16–29.
- Majdalani, N., Vanderpool, C.K., and Gottesman, S. (2005) Bacterial small RNA regulators. *Crit Rev Biochem Mol Biol* **40**: 93–113.
- Mendez-Ortiz, M.M., Hyodo, M., Hayakawa, Y., and Membrillo-Hernandez, J. (2006) Genome-wide transcriptional profile of *Escherichia coli* in response to high levels of the second messenger 3',5'-cyclic diguanylic acid. *J Biol Chem* **281**: 8090–8099.

- Mercante, J., Suzuki, K., Cheng, X., Babitzke, P., and Romeo, T. (2006) Comprehensive alanine-scanning mutagenesis of *Escherichia coli* CsrA defines two subdomains of critical functional importance. *J Biol Chem* **281**: 31832–31842.
- Mondragon, V., Franco, B., Jonas, K., Suzuki, K., Romeo, T., Melefors, O., and Georgellis, D. (2006) pH-dependent activation of the BarA-UvrY two-component system in *Escherichia coli*. *J Bacteriol* **188**: 8303–8306.
- Papenfort, K., Pfeiffer, V., Mika, F., Lucchini, S., Hinton, J.C., and Vogel, J. (2006) SigmaE-dependent small RNAs of Salmonella respond to membrane stress by accelerating global omp mRNA decay. *Mol Microbiol* **62**: 1674–1688.
- Paul, R., Weiser, S., Amiot, N.C., Chan, C., Schirmer, T., Giese, B., and Jenal, U. (2004) Cell cycle-dependent dynamic localization of a bacterial response regulator with a novel di-guanylate cyclase output domain. *Genes Dev* **18**: 715–727.
- Paul, R., Jaeger, T., Abel, S., Wiederkehr, I., Folcher, M., Biondi, E.G., *et al.* (2008) Allosteric regulation of histidine kinases by their cognate response regulator determines cell fate. *Cell* **133**: 452–461.
- Pernestig, A.K., Georgellis, D., Romeo, T., Suzuki, K., Tomenius, H., Normark, S., and Melefors, O. (2003) The *Escherichia coli* BarA-UvrY two-component system is needed for efficient switching between glycolytic and gluconeogenic carbon sources. *J Bacteriol* **185**: 843–853.
- Romby, P., Vandenesch, F., and Wagner, E.G. (2006) The role of RNAs in the regulation of virulence-gene expression. *Curr Opin Microbiol* **9**: 229–236.
- Romeo, T. (1998) Global regulation by the small RNA-binding protein CsrA and the non-coding RNA molecule CsrB. *Mol Microbiol* **29**: 1321–1330.

- Romeo, T., Gong, M., Liu, M.Y., and Brun-Zinkernagel, A.M. (1993) Identification and molecular characterization of *csrA*, a pleiotropic gene from *Escherichia coli* that affects glycogen biosynthesis, gluconeogenesis, cell size, and surface properties. *J Bacteriol* **175**: 4744–4755.
- Romling, U. (2005) Characterization of the *rdar* morphotype, a multicellular behaviour in Enterobacteriaceae. *Cell Mol Life Sci* **62**: 1234–1246.
- Romling, U., and Amikam, D. (2006) Cyclic di-GMP as a second messenger. *Curr Opin Microbiol* **9**: 218–228.
- Romling, U., Rohde, M., Olsen, A., Normark, S., and Reinkoster, J. (2000) AgfD, the checkpoint of multicellular and aggregative behaviour in *Salmonella typhimurium* regulates at least two independent pathways. *Mol Microbiol* **36**: 10–23.
- Romling, U., Gomelsky, M., and Galperin, M.Y. (2005) C-di-GMP: the dawning of a novel bacterial signalling system. *Mol Microbiol* **57**: 629–639.
- Ryjenkov, D.A., Tarutina, M., Moskvina, O.V., and Gomelsky, M. (2005) Cyclic diguanylate is a ubiquitous signaling molecule in bacteria: insights into biochemistry of the GGDEF protein domain. *J Bacteriol* **187**: 1792–1798.
- Sabnis, N.A., Yang, H., and Romeo, T. (1995) Pleiotropic regulation of central carbohydrate metabolism in *Escherichia coli* via the gene *csrA*. *J Biol Chem* **270**: 29096–29104.
- Schmidt, A.J., Ryjenkov, D.A., and Gomelsky, M. (2005) The ubiquitous protein domain EAL is a cyclic diguanylate-specific phosphodiesterase: enzymatically active and inactive EAL domains. *J Bacteriol* **187**: 4774–4781.

- Schubert, M., Lapouge, K., Duss, O., Oberstrass, F.C., Jelesarov, I., Haas, D., and Allain, F.H. (2007) Molecular basis of messenger RNA recognition by the specific bacterial repressing clamp RsmA/CsrA. *Nat Struct Mol Biol* **14**: 807–813.
- Simm, R., Morr, M., Kader, A., Nimtz, M., and Romling, U. (2004) GGDEF and EAL domains inversely regulate cyclic di-GMP levels and transition from sessility to motility. *Mol Microbiol* **53**: 1123–1134.
- Simm, R., Fetherston, J.D., Kader, A., Romling, U., and Perry, R.D. (2005) Phenotypic convergence mediated by GGDEF-domain-containing proteins. *J Bacteriol* **187**: 6816–6823.
- Storz, G., Altuvia, S., and Wassarman, K.M. (2005) An abundance of RNA regulators. *Annu Rev Biochem* **74**: 199–217.
- Suzuki, K., Wang, X., Weilbacher, T., Pernestig, A.K., Melefors, O., Georgellis, D., *et al.* (2002) Regulatory circuitry of the CsrA/CsrB and BarA/UvrY systems of *Escherichia coli*. *J Bacteriol* **184**: 5130–5140.
- Suzuki, K., Babitzke, P., Kushner, S.R., Romeo, T. (2006) Identification of a novel regulatory protein (CsrD) that targets the global regulatory RNAs CsrB and CsrC for degradation by RNase E. *Genes Dev* **20**: 2605–2617.
- Tjaden, B., Goodwin, S.S., Opdyke, J.A., Guillier, M., Fu, D.X., Gottesman, S., and Storz, G. (2006) Target prediction for small, noncoding RNAs in bacteria. *Nucleic Acids Res* **34**: 2791–2802.
- Vogel, J., and Wagner, E.G. (2007) Target identification of small noncoding RNAs in bacteria. *Curr Opin Microbiol* **10**: 262–270.

- Wang, X., Dubey, A.K., Suzuki, K., Baker, C.S., Babitzke, P., and Romeo, T. (2005) CsrA post-transcriptionally represses pgaABCD, responsible for synthesis of a biofilm polysaccharide adhesin of *Escherichia coli*. *Mol Microbiol* **56**: 1648–1663.
- Waters, C.M., Lu, W., Rabinowitz, J.D., and Bassler, B.L. (2008) Quorum sensing controls biofilm formation in *Vibrio cholerae* through modulation of cyclic di-GMP levels and repression of vpsT. *J Bacteriol* **190**: 2527–2536.
- Weber, H., Pesavento, C., Possling, A., Tischendorf, G., and Hengge, R. (2006) Cyclic-di-GMP-mediated signalling within the sigma network of *Escherichia coli*. *Mol Microbiol* **62**: 1014–1034.
- Wei, B.L., Brun-Zinkernagel, A.M., Simecka, J.W., Pruss, B.M., Babitzke, P., and Romeo, T. (2001) Positive regulation of motility and flhDC expression by the RNA-binding protein CsrA of *Escherichia coli*. *Mol Microbiol* **40**: 245–256.
- Weilbacher, T., Suzuki, K., Dubey, A.K., Wang, X., Gudapaty, S., Morozov, I., *et al.* (2003) A novel sRNA component of the carbon storage regulatory system of *Escherichia coli*. *Mol Microbiol* **48**: 657–670.
- White, D., Hart, M.E., and Romeo, T. (1996) Phylogenetic distribution of the global regulatory gene csrA among eubacteria. *Gene* **182**: 221–223.
- Yakhnin, H., Pandit, P., Petty, T.J., Baker, C.S., Romeo, T., and Babitzke, P. (2007) CsrA of *Bacillus subtilis* regulates translation initiation of the gene encoding the flagellin protein (hag) by blocking ribosome binding. *Mol Microbiol* **64**: 1605–1620.

- Yakhnin, A.V., Trimble, J.J., Chiaro, C.R., and Babitzke, P. (2000) Effects of mutations in the 1-tryptophan binding pocket of the Trp RNA-binding attenuation protein of *Bacillus subtilis*. *J Biol Chem* **275**: 4519–4524.
- Yamamoto, K., and Ishihama, A. (2005) Transcriptional response of *Escherichia coli* to external copper. *Mol Microbiol* **56**: 215–227.
- Yamamoto, K., and Ishihama, A. (2006) Characterization of copper-inducible promoters regulated by CpxA/CpxR in *Escherichia coli*. *Biosci Biotechnol Biochem* **70**: 1688–1695.

Table 3-1. Bacterial strains and plasmids used in this study.

Strain or plasmid	Description or genotype	Reference
Strains		
<i>Escherichia coli</i>		
MG1655	F λ^-	Michael Cashel
BW25141	<i>lacI^q rrnBT14 lacZWJ16 phoBR580 hsdR514 araBAD AH33 rhaBADLD78 galU95 endABT333 uidA (MluI)::pir⁺ recA1</i>	Datsenko and Wanner (2000)
TRMG	MG1655 <i>csrA::kan</i>	Romeo <i>et al.</i> (1993)
KSB837	CF7789 $\Delta(\lambda att-lom)::bla\phi$ (<i>csrB-lacZ</i>)1 (Hyb) <i>amp^r</i>	Suzuki <i>et al.</i> (2002)
KJ157	KSB837 <i>csrA::kan^r</i>	This study
KJ227	MG1655 <i>csrB::cat^r</i>	This study
TWMG1655	MG1655 <i>csrC::tet^r</i>	Weilbacher <i>et al.</i> (2003)
KJ230	MG1655 $\Delta csrB$ <i>csrC::tet^r</i>	This study
KJ27	KSB837 <i>yhdA::cat^r</i>	Jonas <i>et al.</i> (2006)
KJ205	MG1655 <i>yhdA::cat^r</i>	This study
AKP199	MG1655 <i>barA::kan^r</i>	Pernestig <i>et al.</i> (2003)
AKP200	MG1655 <i>uvrY::cat^r</i>	Pernestig <i>et al.</i> (2003)
XWMG Δ T	MG1655 <i>ycdT::cat^r</i>	Wang <i>et al.</i> (2005)
KJ295	MG1655 <i>ydeH::cat^r</i>	This study
KJ311	MG1655 $\Delta ydeH$ <i>ycdT::cat^r</i>	This study
KJ331	KJ295 <i>csrA::kan^r</i>	This study
KJ330	XWMG Δ T <i>csrA::kan^r</i>	This study
KJ369	KJ311 <i>csrA::kan^r</i>	This study
<i>S. Typhimurium</i>		
MAE103	$\Delta csgBA102$ <i>adrA101::MudJ</i>	Romling <i>et al.</i> (2000)
Plasmids		
pKD46	Temperature-sensitive λ red recombinase expression vector	Datsenko and Wanner (2000)
pKD3	Template for mutant construction, carries chloramphenicol resistance cassette	Datsenko and Wanner (2000)
pBAD28	pBAD expression plasmid	Guzman <i>et al.</i> (1995)
pBAD <i>csrA</i>	<i>CsrA</i> expression plasmid, <i>csrA</i> is controlled by the plasmid-borne P _{BAD} promoter	This study
pBAD <i>ycdT</i>	<i>YcdT</i> expression plasmid, <i>ycdT</i> is controlled by	This study

pBADydeH	the plasmid-borne P _{BAD} promoter YdeH expression plasmid, <i>ydeH</i> is controlled by the plasmid-borne P _{BAD} promoter	This study
pBADycdT- mut	mutagenized pBADycdT (G359A, G360A)	This study
pBADydeH- mut	mutagenized pBADydeH (G206A, G207A)	This study
pCBZ1	pGE593, Φ (<i>csrB-lacZ</i>)	Gudapaty <i>et al.</i> (2001)
pPYCDT	LacZ reporter plasmid, containing a <i>ycdT-lacZ</i> transcriptional fusion	This study
pPYDEH	LacZ reporter plasmid, containing a <i>ydeH-lacZ</i> transcriptional fusion	This study

Table 3-2. Primers used in this study.

Primer name	Primer sequence (5' to 3')
Genetic approaches	
ydeHKOFor2	ATGGACTGTGCCAGTTTGGTTCGGTGGATTGATCA TCTGGGGCCACTCGTGTAGGCTGGAGCTGCTTC
ydeHKORev2	CGGTTTGCTTACCCTCATAATTGCCCGGTCCGC TCTTCCAATGACCATATGAATATCCTCCTTAG
ydeHKOtestFor	ACAAGGAACTGTGAAAAAG
ydeHKOtestRev	ATCGTTGACACAGTAGCA
csrBKOfor	GAGTCAGACAACGAAGTGAACATCAGGATGATG ACACTTCTGCGTAGGCTGGAGCTGCTTC
csrBKOREV	AATAAAAAAAGGGAGCACTGTATTCACAGCGCT CCCGGTTTCGTTTATATGAATATCCTCCTTAG
csrBKOtestFor	GTAGGAGATCGCCAGGAAAT
csrBKOtestRev	CACGCAGTAACGCTTCAAGC
CsrAForBAD	ACCTCTAGATCTTTCAAGGAGCAAAGAATG
CsrAREVBAD	ACCAAGCTTGATGAGACGCGGAAAGATTA
pBADydeHFor	ACCTCTAGAGTGAAAAAGGAGTGGCAATG
pBADydeHRev	ACCAAGCTTTGAATGTTAAACGGAGCTTA
pBADycdTFor2	ACCGAGCTCAGATTGGTGTAGCTTTATG
pBADycdTRev2	ACCTCTAGAAGGATCAAAATGCCGCTTTA
YcdT-Mut-For	TAGCGCGCGTCGCCGCCGAAGAGTTTGGC
YcdT-Mut-Rev	GCCAAACTCTTCGGCGGCGACGCGCGCTA
YdeH-Mut-For	GAAACGGTTTATCGCTACGCGGCCGAAGAATTT ATCATTATTG
YdeH-Mut-Rev	CAATAATGATAAATTCTTCGGCCGCGTAGCGAT AAACCGTTTC
PydeHFor-EcoRI	ACCGAATTCTAAATTAGCCTGATGGCCTG
PydeHRev-BamHI	ACCGGATCCTGCGCGCTATTCTAACGAG
PycdTFor-EcoRI	ACCGAATTCTATTACTCCATGTATTGCC
PycdTRev-BamHI	ACCGGATCCTTCTATTATTAATAGATATAAG
Real-time PCR	
RTrnDFor	AGTTCCAGTGTGGCTGGTCAT
RTrnDRev	GCTCACCAAGGCGACGAT
RTcsrAFor	TGGTGAGACCCTCATGATTGG
RTcsrARev	CGTACCTGGTTGCCCTTTACC
RTcsrBFor	CAAGGATGAGCAGGGAGCAA
RTcsrBRev	CGCTCCCGGTTTCGTTTC
RTpgaAFor	TCGAACGTGAACCGCAAGA
RTpgaARev	ATGTACATCAACCGCACGTTTT
RTycdTFor	ACGCCTTATTGCGTCATGATT
RTycdTRev	CCCCAGGTGTCGTTGACTTT

RTydeHFor	AATAAGGCTATCGATGCCCACTAC
RTydeHRev	CGCGACCACGCTGTGA
RTyddVFor	TGCCCAGGTTGACGATGTC
RTyddVRev	ACTTCCGCGACGGTATGC
RTdosFor	CGCCGATGGCATTTTTTT
RTdosRev	ATTAACACCGCACCCATCATATT
RTyliEFor	TCGGTGGCTTCAGATGACTCT
RTyliERev	GGACGATCAAAGCAATTGTATGC
RTyliFFor	CCTGGACGACCTGACCAA
RTyliFRev	GCGCTTTTAAATCTTCGTCAAAG
RTyhdAFor	GCCACGCTCACCGTTTAAGA
RTyhdARev	GCCGGGCAAGAATTGCT
RTyhjKFor	AGCCGGGAACACTGATTCTG
RTyhjKRev	GCATGAGGGTCGTCAATACGT
RTyjcCFor	GGCGCTGAAGCGTTGTTAC
RTyjcCRev	TCTGCCGGATTCATTATTTGC
5' RACE	
AAP	GGCCACGCGTCGACTAGTACGGGIIGGGIIGGGIIG
UAP	CUACUACUACUAGGCCACGCGTCGACTAGTAC
YcdTGSP1	CTGACGAAACAAATAAT
YcdTGSP2HindIII	ACCAGGCTTGCTTGTCAAACGCTCCTCAATAA
YcdTGSP3HindIII	ACCAGGCTTATTGCCTACGGTCATAAATGAAAT
RNA gel mobility shift assays	
ycdT-T7	TAATACGACTCACTATAGGGAAAGGGATCTACA ACCTACAGATTGGTGTAGCTTTATGGAAAAAGA CTATTTGAG
GC ycdT-T7	CTCAAATAGTCTTTTTCCATAAAGCTACACCAAT CTGTAGGTTGTAGATCCCTTTCCCTATAGTGAGT CGTATTA
ydeH-T7	TAATACGACTCACTATAGGGCACAAGGAACTGT GAAAAAGGAGTGGCAATGATCAAGAAGACAAC GGAAATTG
GC ydeH-T7	CAATTTCCGTTGTCTTCTTGATCATTGCCACTCCT TTTTCACAGTTCCTTGTGCCCTATAGTGAGTCGT ATTA

Bold letters indicate the sites, where point mutations have been introduced. Italic letters indicate the recognition sites for restriction enzymes.

FIGURE LEGENDS

Fig. 3-1. Identification of *ycdT* and *ydeH* as novel targets for CsrA. Plasmid-encoded *csrA* (pBAD_{csrA}) was expressed in KJ157 (*csrA::kan*) upon induction with 0.1% arabinose at OD₆₀₀ 1.5. A. Increased *csrA* expression in response to arabinose addition (0 min) was measured by real-time RT-PCR over time. CsrA is assumed to bind to its direct mRNA targets, to inhibit translation and thereby to destabilize the mRNAs. B. mRNA levels of the known CsrA target *pgaA* rapidly decreased within a few minutes after pBAD_{csrA} induction. C. The indirect CsrA target *csrB* was changed in expression first after 12 min. D. A genome-wide screen for genes, whose transcript levels decrease within 4 and 12 min (more than threefold compared with 0 min) in response to CsrA overexpression, identified *ycdT* and *ydeH* as novel CsrA targets. E. The *ycdT* gene is located adjacent to the *pga* operon and is divergently transcribed. F. YcdT harbours eight transmembrane regions and is predicted to contain a GGDEF motif. G. YdeH contains a GGDEF motif and is predicted to be cytoplasmic.

Fig. 3-2. CsrA-dependent regulation of *ycdT* and *ydeH* expression measured by real-time RT-PCR. A. Induction of pBAD_{csrA} with 0.1% arabinose (at 0 min) leads to a rapid decrease in *ycdT* (squares) and *ydeH* (circles) transcript levels during late (OD₆₀₀ 1.5) exponential growth. B. Similar results were observed during early exponential growth (OD₆₀₀ 0.5). C. Induction of pBAD28 had no effect on *ycdT* and *ydeH* mRNA levels. D. In the *csrA::kan* mutant TRMG1655 (open symbols), *ycdT* mRNA levels (dashed line) were strongly increased compared with the wild-type MG1655 (filled symbols) over the entire growth cycle. E. Likewise, *ydeH* expression (dashed line) was significantly higher

in the *csrA* mutant. F. Analysis of *ycdT*, *ydeH* and *csrA* (diamonds) expression over time in the wild type indicates that *ycdT* and *ydeH* are inversely regulated with respect to *csrA*.

Fig. 3-3. Effects of other components of the BarA-UvrY-Csr network on *ycdT* and *ydeH* expression. mRNA levels of *ycdT* (A) and *ydeH* (B) were measured in MG1655 (wt), TRMG (*csrA*), KJ230 (*csrB csrC*), KJ205 (*csrD*), AKP200 (*uvrY*) and AKP199 (*barA*) by real-time RT-PCR when the bacterial cultures had reached an OD₆₀₀ of 1.5.

Fig. 3-4. Physical interaction between CsrA and *ycdT* and *ydeH* transcripts. A. The transcription start site for *ycdT* was determined by 5'RACE. An approximately 410 nt PCR product was detected after amplification of reverse-transcribed cDNA with the gene-specific primer GSP2 and the adapter primer AAP [lane 1 (I)]. The product of a second nested PCR reaction with primers GSP3 and UAP was approximately 100 nt shorter [lane 2 (II) – as labelled in figure]. Sequencing of the shorter fragment identified A (35 nt upstream of ATG) as transcription start site. Analysis of the 5' leader of *ycdT* suggests two potential CsrA binding sites (underlined). B. Sequence analysis of the intergenic region of *ydeH* suggests two potential CsrA binding sites (underlined), one of them overlapping the Shine–Dalgarno sequence (SD). C and D. Gel mobility shift analyses of CsrA–*ycdT* and CsrA–*ydeH* interactions in the absence of RNA competitor. 5' end-labelled *ycdT* or *ydeH* transcripts (80 pM) were incubated with CsrA at the indicated concentrations. The positions of free (F) and bound (B) RNA are shown. E and F. Competition reactions using specific (*ycdT*, *ydeH*) or non-specific (*trpL* from *B. subtilis*) unlabelled RNA competitors. The concentration of competitor RNA is shown at the

bottom of each lane. G. β -Galactosidase activity for plasmid-encoded transcriptional *ycdT*-, *ydeH*- and *csrB-lacZ* fusions in wild-type MG1655 and its *csrA* mutant. Bacteria containing pPYCDT, pPYDEH or pCBZ1 respectively were grown until OD₆₀₀ 1.5. The mean values and the standard deviations were calculated for each strain from two parallel experiments.

Fig. 3-5. The effects of YcdT and YdeH on motility. Motility was analysed by measuring the diameter of the swimming zone on 0.3% agar plates, supplemented with 0.1% arabinose, if necessary. A representative image of a motility agar plate for MAE103 carrying pBAD28, pBADycdT, pBADydeH or pBADcsrA is illustrated. All motility assays were repeated at least two times independently and the mean and the standard deviation were calculated. A. MG1655 (wt), carrying pBAD28, pBADycdT, pBADycdT-mut, pBADydeH, pBADydeH-mut or pBADcsrA. B. *S. Typhimurium* strain MAE103, carrying pBAD28, pBADycdT, pBADycdT-mut, pBADydeH, pBADydeH-mut or pBADcsrA. C. MG1655 (wt) and mutants XWVGΔT (*ycdT*), KJ295 (*ydeH*) and the double mutant KJ311 (*ycdT ydeH*). D. MG1655 and mutants TRMG (*csrA*), KJ331 (*csrA ycdT*), KJ330 (*csrA ydeH*) and KJ369 (*csrA ycdT ydeH*).

Fig. 3-6. High-resolution AFM analysis of cell morphology. Bacteria were grown on mica surfaces for 24 h at 28°C in LB medium containing 0.1% arabinose, but no salt. Afterwards the samples were air-dried and analysed with the AFM in contact mode. Representative images were chosen for presentation. A. Lower (first row) and higher magnification (second row) AFM images of MG1655 (wt), carrying pBAD28,

pBADydeH or pBADycdT. The arrows highlight the appearance of flagella (F) and pili (P). B. Flagella expression was quantified by counting the number of flagella per total number of bacteria at five different locations on the microscope slide. The mean values and the standard deviations were calculated for each strain.

C. Pili expression was quantified by counting the number of bacteria expressing pili per total number of bacteria at five independent sites, from which the mean and standard deviation were determined.

Fig. 3-7. Functional characterization of YcdT and YdeH. A. The amino acid sequences of YcdT and YdeH were compared with other GGDEF domain proteins from *Caulobacter crescentus* (Cc), *S. Typhimurium* (ST), *Y. pestis* (Yp) and *E. coli* (Ec), proven to synthesize c-di-GMP (PleD, AdrA, HmsT, YedQ and YdaM) or demonstrated not to be involved in c-di-GMP metabolism (CsrD). Dark background indicates a high level of similarity between the proteins. The stars (*) depict amino acid residues that have been demonstrated to be critical for substrate binding or catalysis (Chan *et al.*, 2004). B. c-di-GMP concentrations were determined in MG1655 carrying pBAD28, pBADydeH or pBADycdT grown to OD₆₀₀ 1.5 in LB medium with 0.1% arabinose at 37°C. C. c-di-GMP concentrations of wt MG1655 and its isogenic *csrA* mutant TRMG, cultivated under equal conditions as (B), but without arabinose. D. Expression of pBADydeH in the *Salmonella adrA* mutant MAE103 successfully restored cellulose production as visualized on CF, when grown for 20 h at 28°C on LB agar with 0.1% arabinose, but without salt. No dye binding was observed for MAE103 carrying pBADycdT, pBADcsrA or the control vector pBAD28. E. c-di-GMP measurements in *Salmonella* MAE103,

carrying pBAD28, pBADydeH and pBADycdT, grown for 20 h at 28°C on LB agar with 0.1% arabinose, but without salt.

Fig. 3-8. The global effect of CsrA on GGDEF/EAL proteins. A. All 29 *E. coli* genes encoding GGDEF, GGDEF-EAL or EAL proteins were analysed for CsrA-dependent changes in gene expression using the array data. Genes expressed at levels too low for microarray detection are indicated with a star (*). B. The kinetics of CsrA-dependent downregulation of *ycdT*, *ydeH*, *yliE*, *yliF*, *yddV*, *dos* and *csrD* upon induction of pBADcsrA were confirmed by RT-PCR. C. Expression of pBAD28 did not lead to a decrease in *ycdT*, *ydeH*, *yliE*, *yliF*, *yddV*, *dos* and *csrD* expression. D. The ratio in mRNA levels between TRMG (*csrA::kan*) and MG1655 (wt) was determined for *ycdT*, *ydeH*, *yliE*, *yliF*, *yddV*, *dos* and *csrD*, indicating that expression of these genes is increased in the *csrA* mutant. E. Four of the CsrA-regulated genes encode GGDEF proteins (*ycdT*, *ydeH*, *yddV* and *yliF*), two GGDEF-EAL proteins (*dos*, *csrD*) and one of them encodes an EAL protein (*yliE*). F. *yliE* and *yliF* are organized as an operon. G. Likewise, *yddV* and *dos* are present in an operon.

Fig. 9. Schematic view of the interconnection between Csr and c-di-GMP signalling in *E. coli*. The activity of the central player CsrA is controlled by the sRNAs CsrB and CsrC, which are regulated by the BarA-UvrY two-component system and CsrD, a GGDEF-EAL protein not involved in c-di-GMP metabolism. CsrA directly acts on motility and biofilm formation, by controlling mRNA levels of *flhDC* and *pgaA* respectively. In addition, CsrA controls indirectly the switch between a motile and a

sessile life styles by regulating the levels of c-di-GMP through post-transcriptional regulation of the GGDEF proteins YcdT and YdeH and possibly additional proteins with GGDEF or EAL domains. Signals from the outside controlling the CsrA- and c-di-GMP-specific adaptive responses are integrated through the BarA-UvrY TCS and possibly through CsrD and YcdT. Transcription of *ydeH* was shown to be controlled by the CpxAR two-component system in response to cell envelope stress and external copper.

Fig. 3-1.

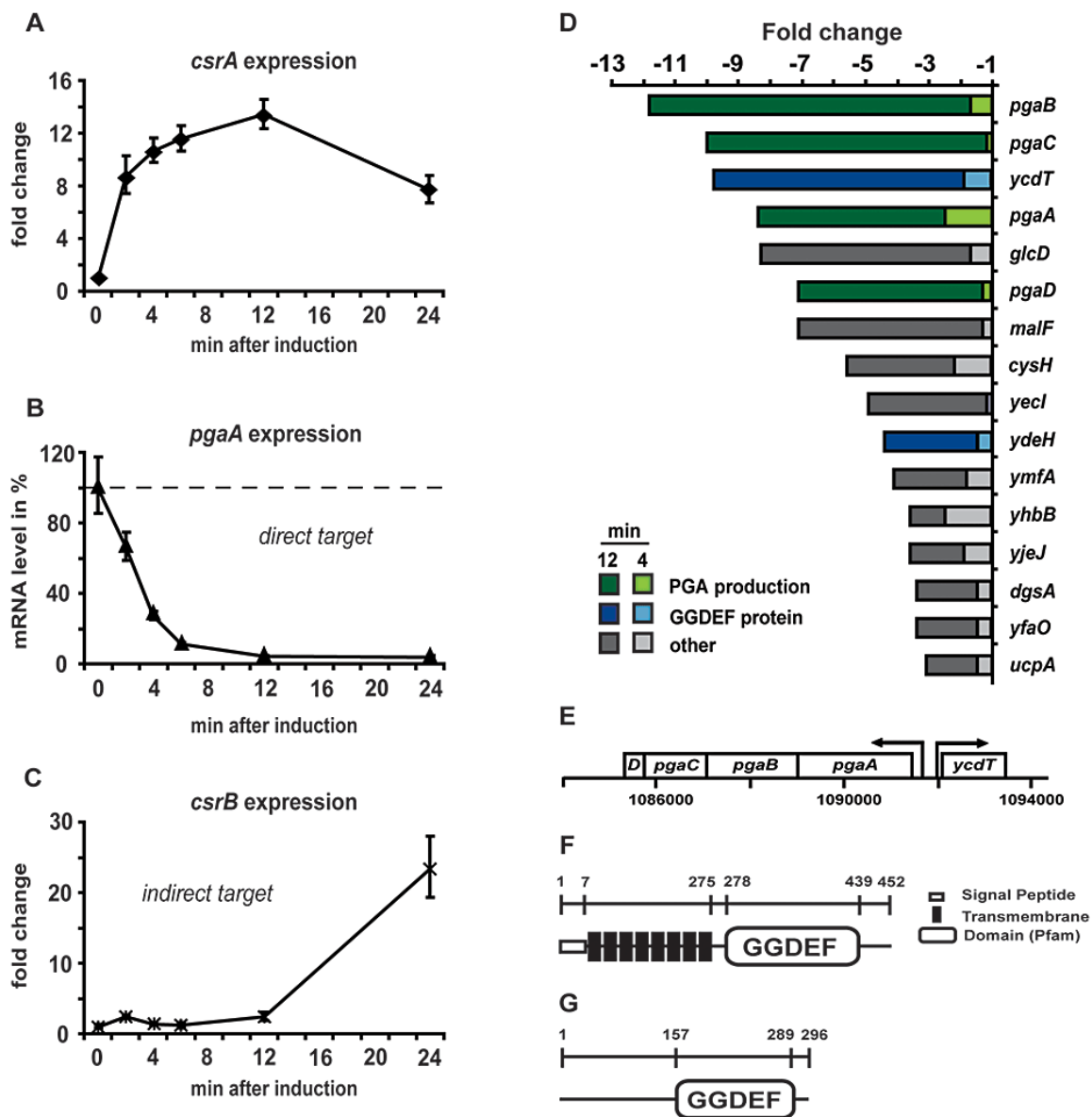


Fig. 3-2.

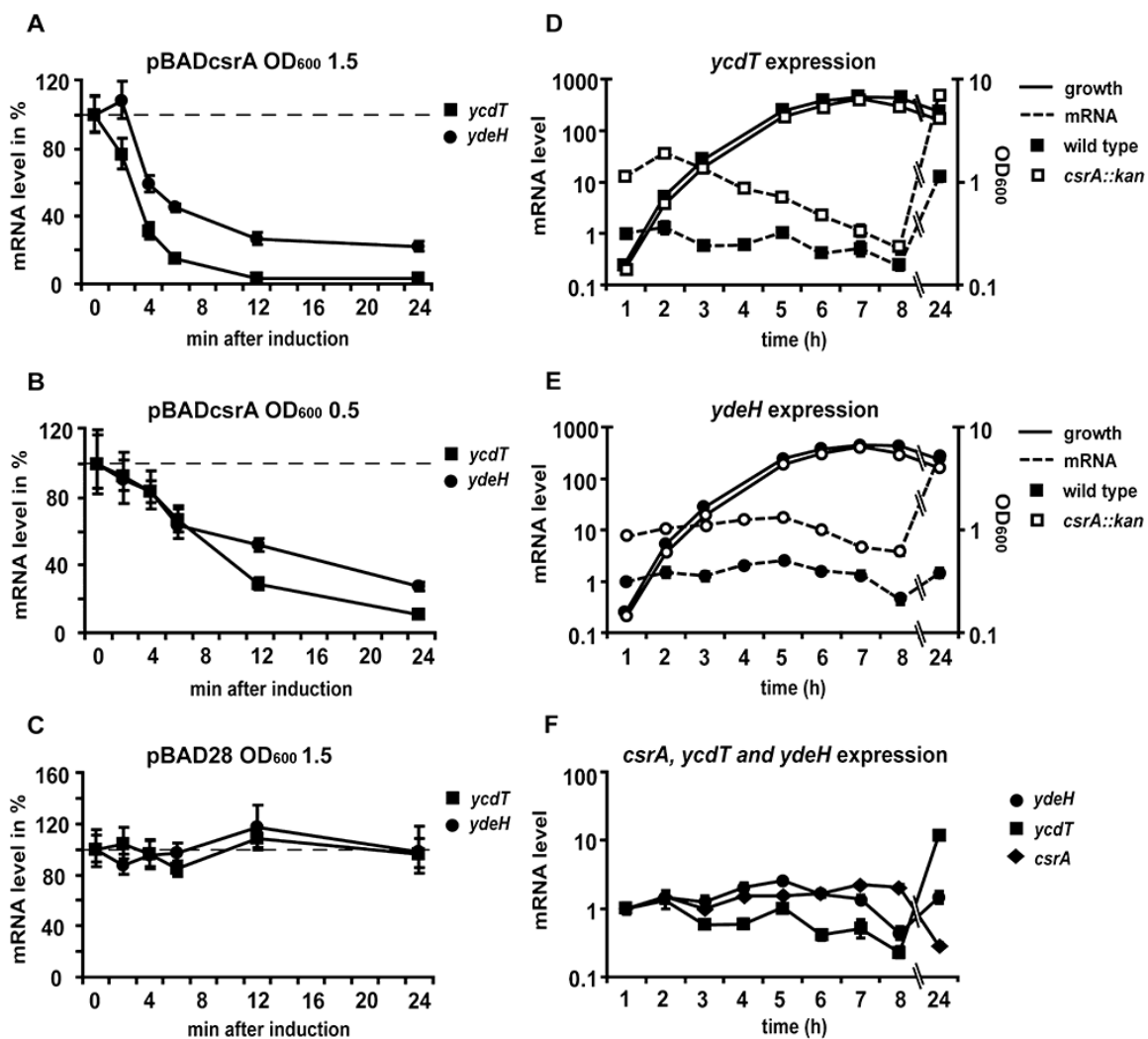


Fig. 3-3.

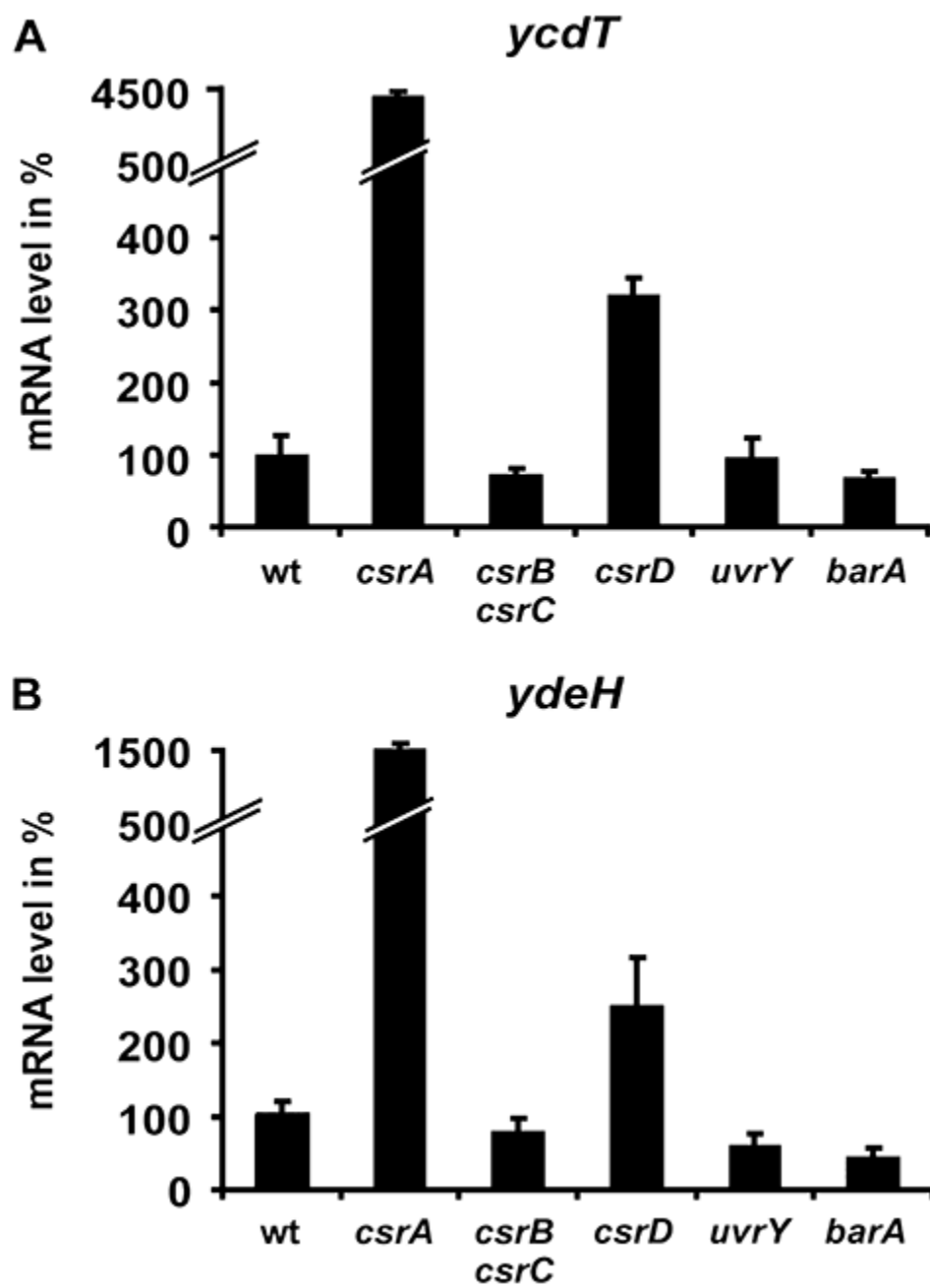


Fig. 3-4.

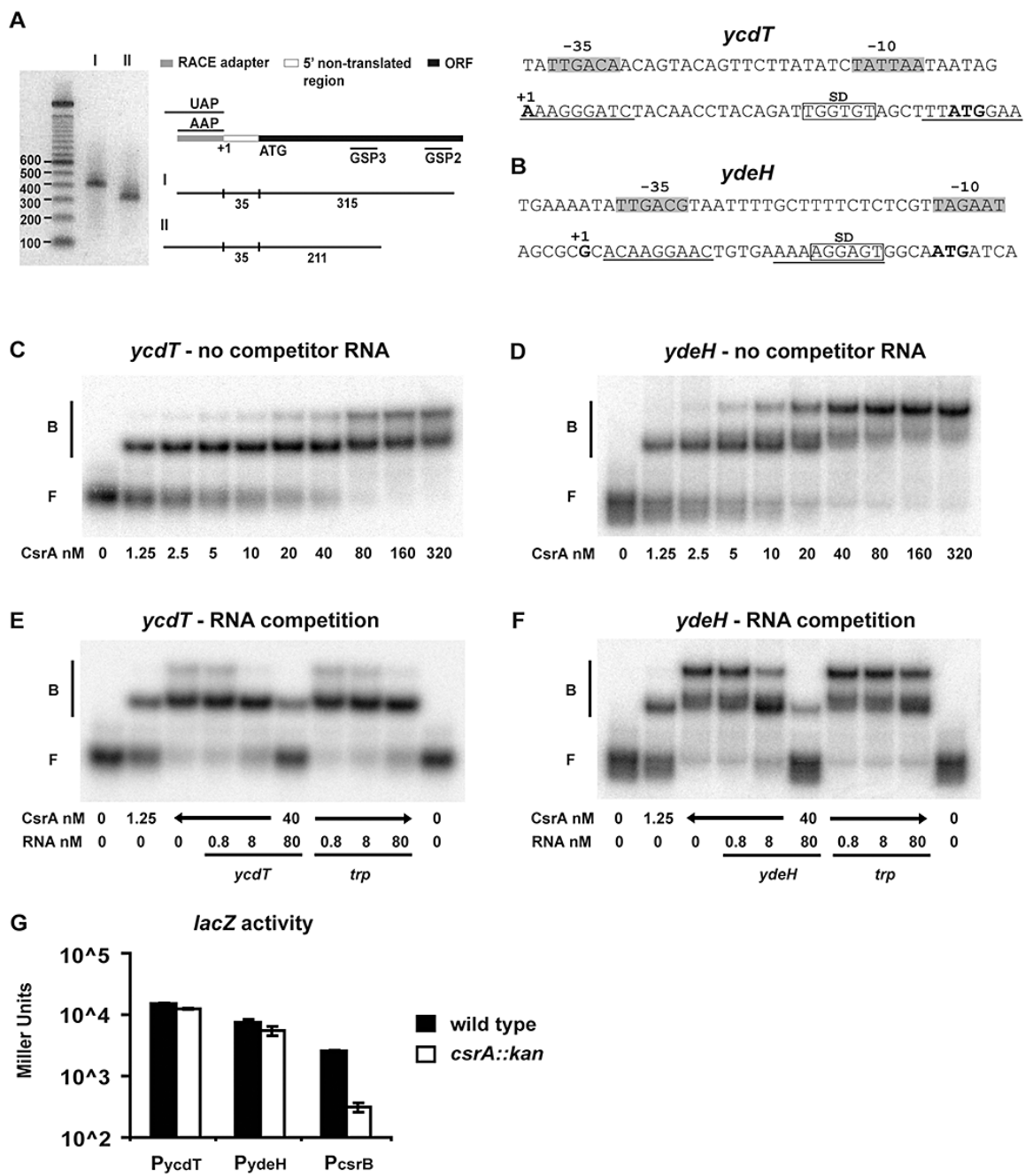


Fig. 3-5.

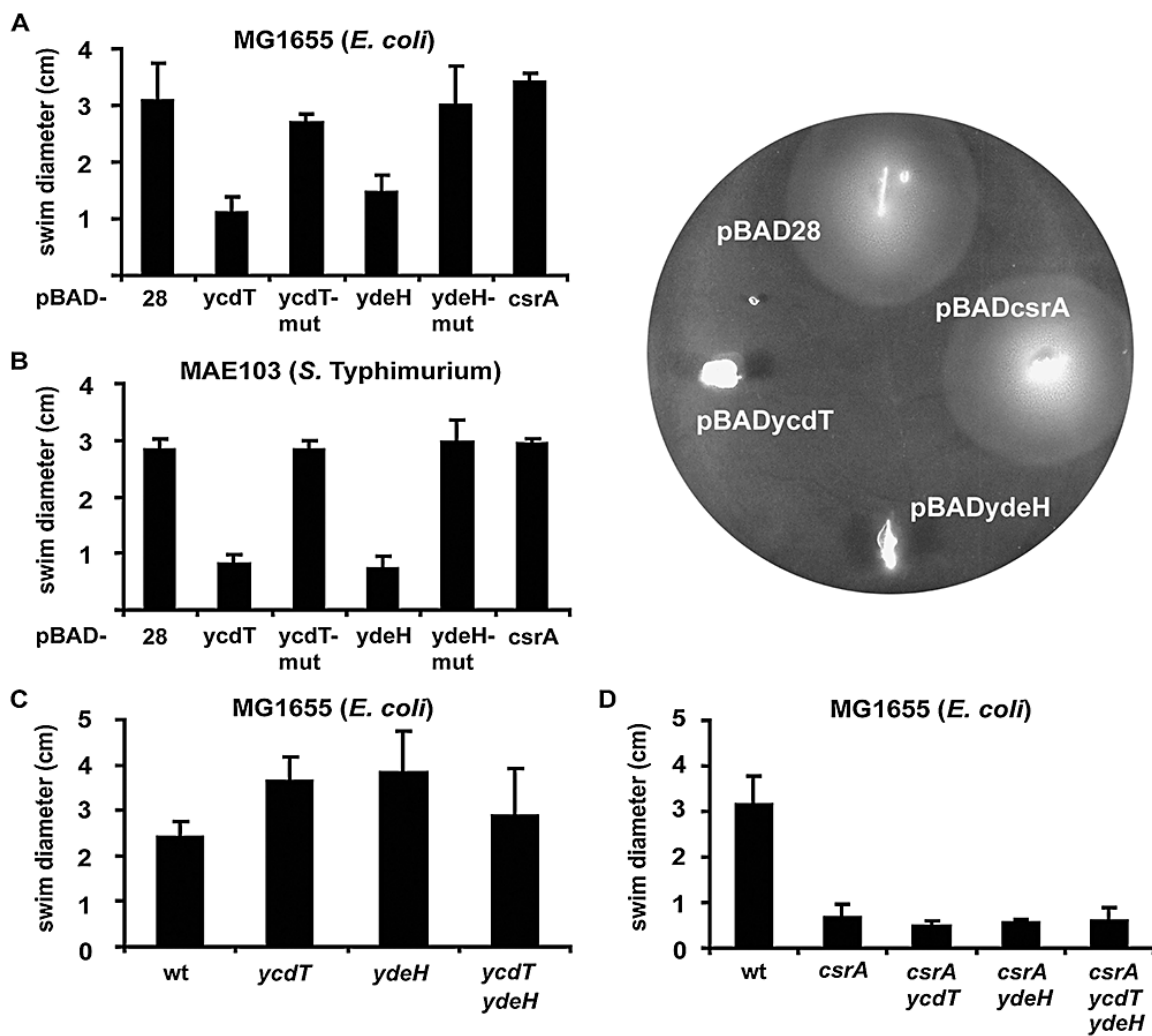


Fig. 3-6.

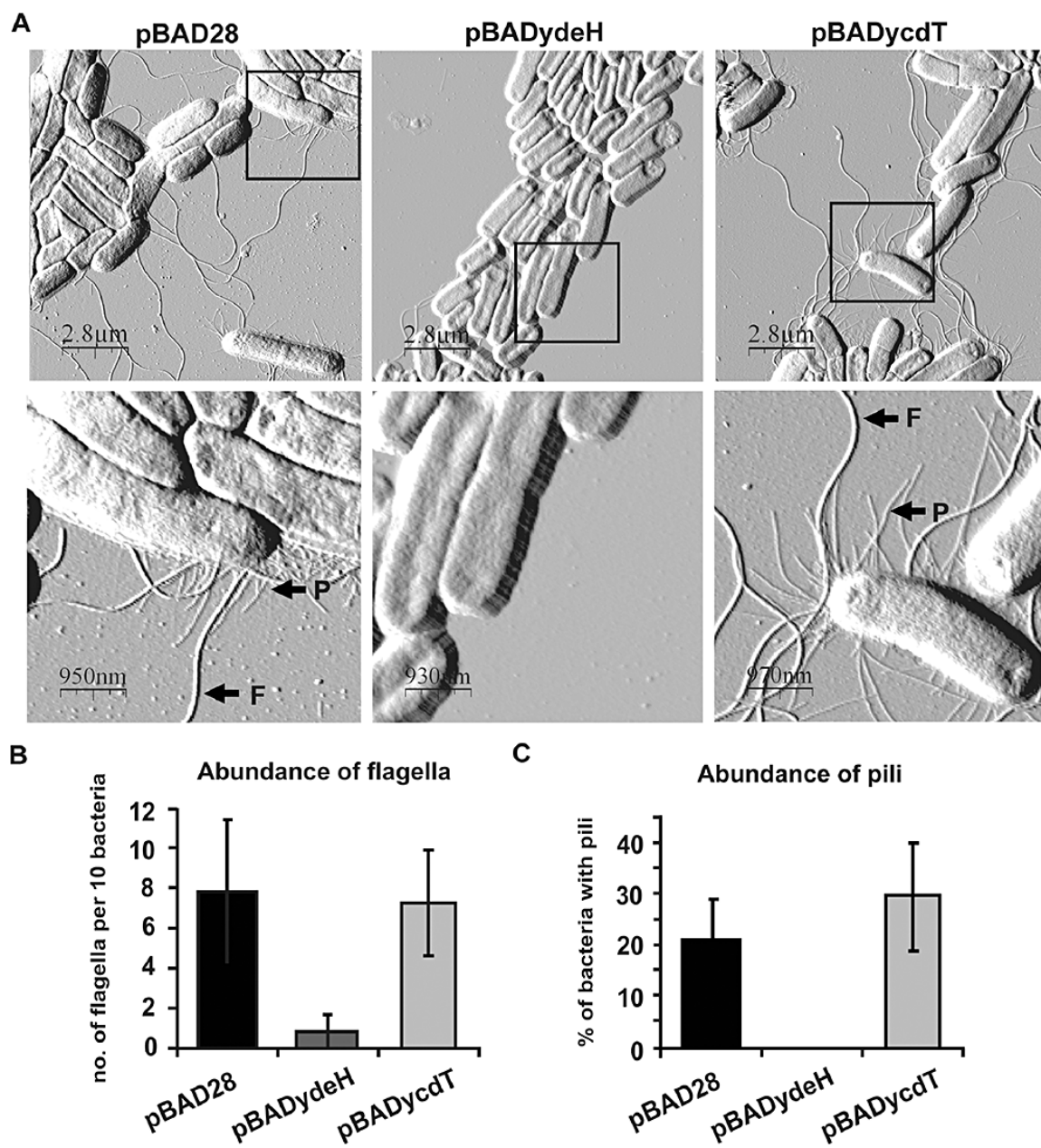
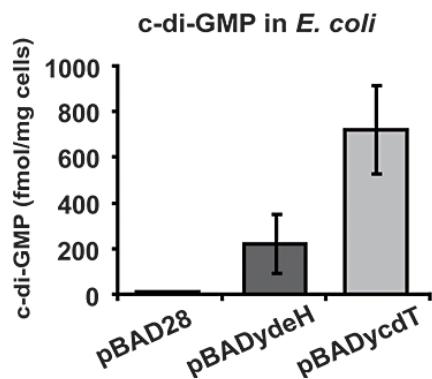


Fig. 3-7.

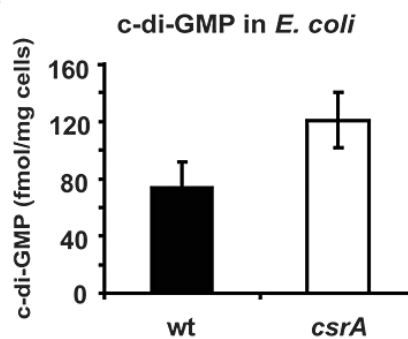
A

YcdT (Ec)	287	LTNIENR	318	DIDHFKKVNDTWGHVVD	350	R--PDDLARVGGEEF	425	ADNAYEAK
YdeH (Ec)	134	LTGLPGR	165	DIDRFKLVNDTYGHLIGD	197	R--DYETVYRYGGEEF	269	ADRAMYEGK
PleD (Cc)	294	LTGLHNR	327	DIDFFKKINDTFGHDIGD	357	R--AIDLPCRVGEEF	434	ADEGVYQAK
AdrA (ST)	214	MTGVYNR	247	DIDHFKSINDTWGHDVVD	277	R--GSDIIGRFGGDEF	351	ADMAIYKAK
HmsT (Yp)	225	LTSLYNR	255	DIDHFKAYNDNYGHTMGD	285	R--SRDIVVRYGGEEF	361	ADEALYRAK
YedQ (Ec)	403	LTRLVNR	436	DIDHFKAINDRFGHQAGD	468	R--AQDVAGRVGEEF	543	ADRRLYLAK
YdaM (Ec)	258	MTGLLNR	291	DTDRFKHINDLYGHSKGD	323	R--KGLVFRVGGEEF	392	VDDALYRAK
CsrD (Ec)	227	KTGLNNR	262	RLPDFNMLSDTWGHSSQVE	296	MRYPGALLARYHRSDF	367	AESATRNAG

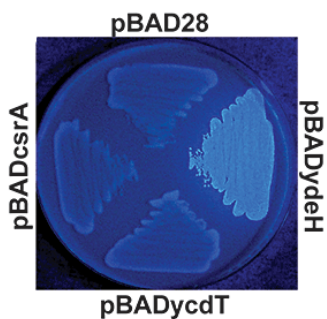
B



C



D

Cellulose production in *Salmonella*

E

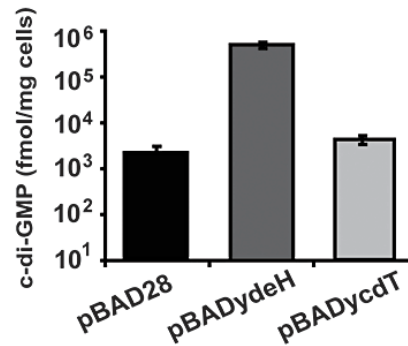
c-di-GMP in *Salmonella*

Fig. 3-8.

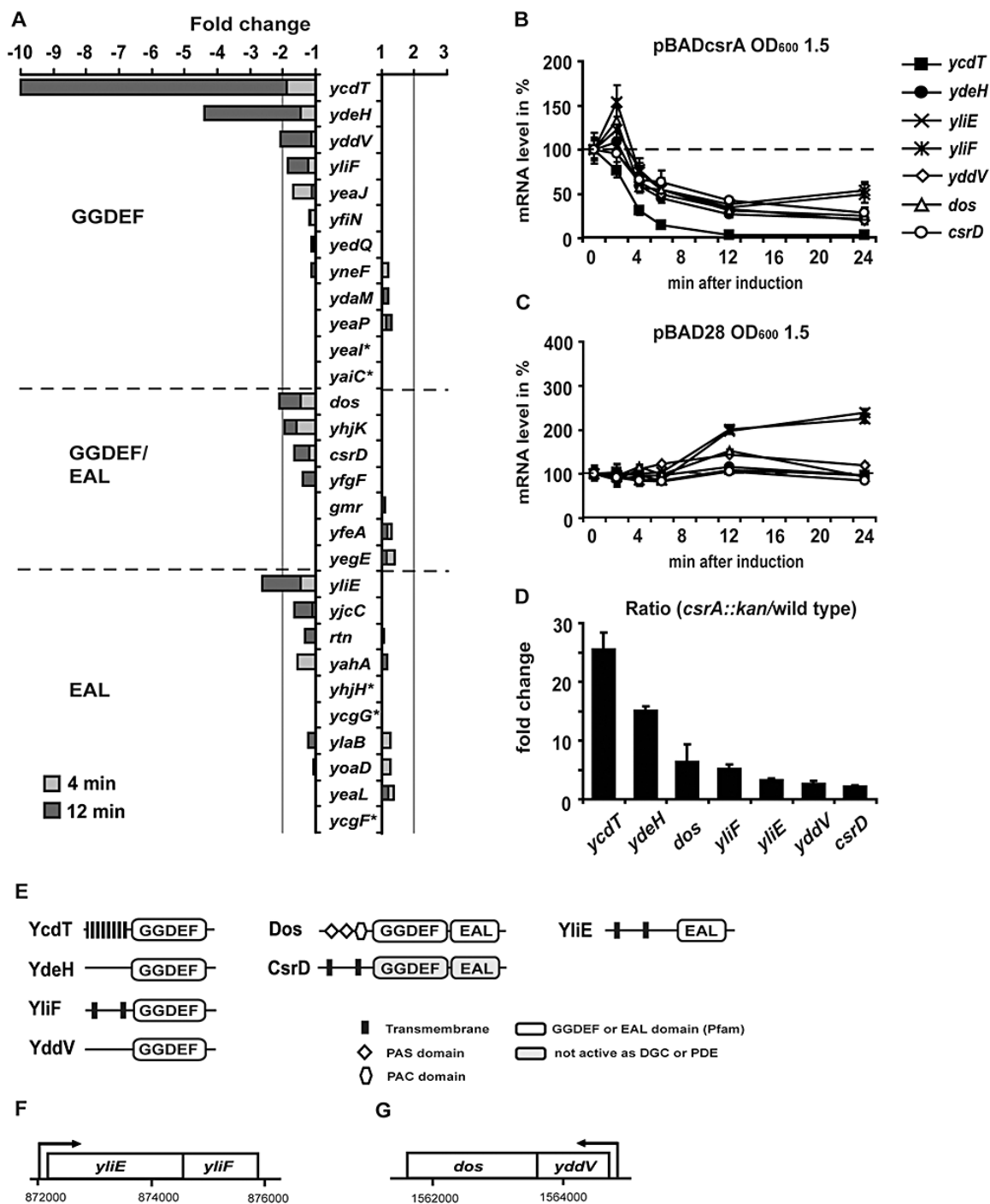
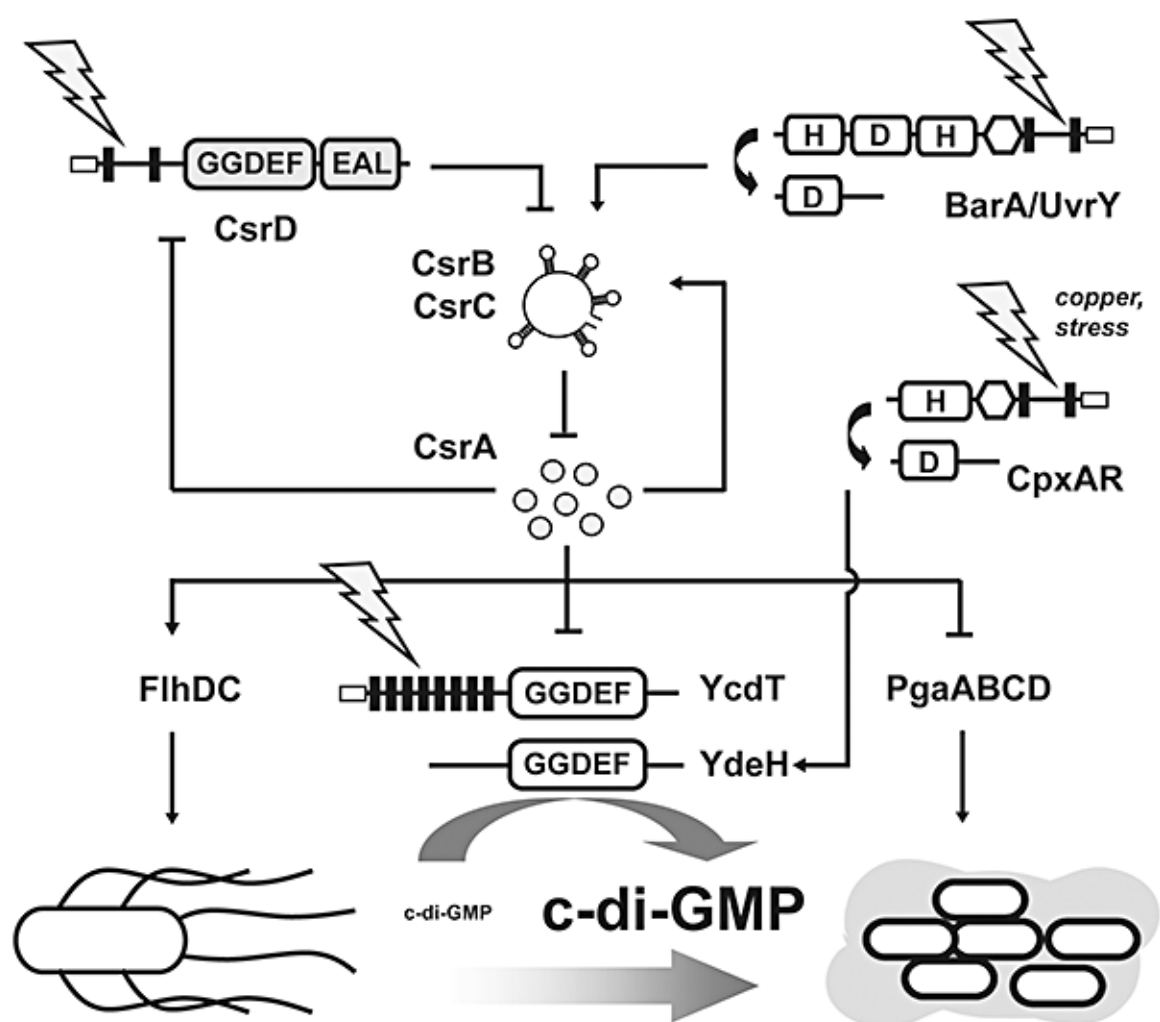


Fig. 3-9.



Chapter 4. Complex regulatory network encompassing the Csr, c-di-GMP and motility systems of *Salmonella*

Typhimurium

Kristina Jonas^{1,2*†}, Adrienne N. Edwards³, Irfan Ahmad¹, Tony Romeo^{3,4}, Ute Römling¹
and Öjar Melefors^{1,2}

¹Department of Microbiology, Tumor and Cell Biology, Karolinska Institutet, SE-17177 Stockholm, Sweden, ²Swedish Institute for Infectious Disease Control, SE-17182, Solna, Sweden, ³Department of Microbiology and Immunology, Emory University School of Medicine, Atlanta, Georgia 30322, USA, ⁴Department of Microbiology and Cell Science, University of Florida, Gainesville, Florida 32611-0700, USA, Correspondence to *E-mail kjonas@mit.edu; Tel. (+1) 617 2533677; Fax (+1) 617 253 8699, †Present address: Department of Biology, Massachusetts Institute of Technology, Cambridge, MA 02139, USA.

This manuscript was published in *Environmental Microbiology*, 2010 Feb; 12(2):524-40.
Adrienne N. Edwards performed the RNA electrophoretic mobility shift assays in this study.

ABSTRACT

Bacterial survival depends on the ability to switch between sessile and motile lifestyles in response to changing environmental conditions. In many species, this switch is governed by (3'-5')-cyclic-diguanosine monophosphate (c-di-GMP), a signalling molecule, which is metabolized by proteins containing GGDEF and/or EAL domains. *Salmonella* Typhimurium contains 20 such proteins. Here, we show that the RNA-binding protein CsrA regulates the expression of eight genes encoding GGDEF, GGDEF-EAL and EAL domain proteins. CsrA bound directly to the mRNA leaders of five of these genes, suggesting that it may regulate these genes post-transcriptionally. The c-di-GMP-specific phosphodiesterase STM3611, which reciprocally controls flagella function and production of biofilm matrix components, was regulated by CsrA binding to the mRNA, but was also indirectly regulated by CsrA through the FlhDC/FliA flagella cascade and STM1344. STM1344 is an unconventional (c-di-GMP-inactive) EAL domain protein, recently identified as a negative regulator of flagella gene expression. Here, we demonstrate that CsrA directly downregulates expression of STM1344, which in turn regulates *STM3611* through *fliA* and thus reciprocally controls motility and biofilm factors. Altogether, our data reveal that the concerted and complex regulation of several genes encoding GGDEF/EAL domain proteins allows CsrA to control the motility-sessility switch in *S. Typhimurium* at multiple levels.

INTRODUCTION

The survival of bacteria in diverse environments largely depends on their ability to adjust their life style according to the surrounding conditions. An important factor that

mediates the choice of an appropriate life style in various bacteria is the signalling molecule (3'-5')-cyclic-diguanosine monophosphate (c-di-GMP) (Hengge, 2009, Jonas *et al.*, 2009, Romling and Simm, 2009). In general, high intracellular levels of this second messenger promote sedentary biofilm-associated phenotypes, whereas low concentrations of c-di-GMP favour motility. In several bacteria, c-di-GMP has also been associated with the regulation of virulence and other phenotypes (Tamayo *et al.*, 2007, Cotter and Stibitz, 2007). c-di-GMP is synthesized by diguanylate cyclases (DGCs), which contain catalytically active GGDEF domains, and degradation of the second messenger is mediated by phosphodiesterases (PDE), which harbour either EAL or HD-GYP domains (Christen *et al.*, 2005, Paul *et al.*, 2004b, Ryjenkov *et al.*, 2005, Schmidt *et al.*, 2005, Simm *et al.*, 2004, Ryan *et al.*, 2006). Notably, individual bacterial genomes frequently encode numerous GGDEF and EAL/HD-GYP proteins (Galperin, 2004, Galperin *et al.*, 2001), implying that the c-di-GMP network is a highly complex and tightly regulated intracellular signalling system (Jonas *et al.*, 2009).

The ability to switch between different life styles is crucial for bacteria such as *Salmonella* that alternate between distinct niches in host organisms during infection as well as in the abiotic environment, in which they can persist for weeks in food, soil, water and other habitats. *Salmonella enterica* serovar Typhimurium contains a c-di-GMP system comprised of 5 GGDEF domain proteins, 7 GGDEF-EAL and 8 EAL domain proteins (Romling, 2005). The characterization of the phenotypes of these proteins has been the subject of several previous studies (Simm *et al.*, 2007, Solano *et al.*, 2009, Kader *et al.*, 2006, Garcia *et al.*, 2004). However, little is known about the regulation of the *Salmonella* c-di-GMP system by intra- and extracellular factors.

In the closely related species *Escherichia coli*, the carbon storage regulator CsrA controls the expression of at least seven of 29 genes encoding GGDEF/EAL domain proteins at the post-transcriptional level (Jonas *et al.*, 2008). Members of the CsrA (RsmA) family are homodimeric RNA-binding proteins (Mercante *et al.*, 2009) that are widely distributed among eubacteria and control various phenotypes including biofilm formation, motility, carbon flux, secondary metabolism, quorum sensing as well as interactions with animal and plant hosts (Lapouge *et al.*, 2008, Romeo, 1998, Lucchetti-Miganeh *et al.*, 2008, Babitzke and Romeo, 2007). In γ -proteobacteria CsrA proteins are antagonized by small non-coding RNAs (sRNAs) that bind and sequester multiple copies of CsrA (Lapouge *et al.*, 2008, Babitzke and Romeo, 2007). Transcription of the sRNAs is controlled by a two-component system (BarA-UvrY in *E. coli*, BarA-SirA in *S. Typhimurium*), permitting the integration of environmental signals into the Csr system (Lapouge *et al.*, 2008, Babitzke and Romeo, 2007).

By directly binding to target mRNAs CsrA can either down- or upregulate the expression of target genes (Babitzke and Romeo, 2007). CsrA binding to the mRNAs of the GGDEF proteins YcdT and YdeH in *E. coli* led to a strong downregulation in transcript levels (Jonas *et al.*, 2008). Both proteins encode DGCs, which inhibit motility. YdeH is also involved in the positive regulation of biofilm formation (Boehm *et al.*, 2009). Thus, by regulating the expression of these GGDEF domain proteins CsrA controls motility and biofilm behaviour in a c-di-GMP dependent manner. In addition, CsrA enhances motility and reciprocally inhibits biofilm formation in *E. coli* by binding to and stabilizing the transcript of the flagella master regulator FlhDC (Wei *et al.*, 2001) and by blocking translation of *pgaA* and destabilizing *pgaABCD* mRNA (Wang *et al.*,

2005), which encodes the synthesis and secretion apparatus of the PGA (poly- β -1,6-N-acetylglucosamine) biofilm polysaccharide adhesin (Itoh *et al.*, 2008).

In contrast to *E. coli*, the role of CsrA in the regulation of the sessility-motility switch is less well understood in *Salmonella*. *S. Typhimurium* has a CsrA orthologue that is identical in its amino acid sequence to CsrA in *E. coli*. However, *S. Typhimurium* contains neither the *pga* operon nor orthologues of *ycdT*, *ydeH* and most of the other GGDEF/EAL genes that are regulated by CsrA in *E. coli*. Although CsrA regulates genes belonging to the flagella synthesis cascade as well as genes required for virulence (Lawhon *et al.*, 2003, Altier *et al.*, 2000a), no direct mRNA targets have been identified in *Salmonella*. Here, we show that CsrA controls the expression of eight genes encoding GGDEF/EAL domain proteins in *S. Typhimurium* by both direct and indirect mechanisms. The complex regulation of these genes enables CsrA to act at multiple levels in the signalling hierarchy mediating the switch between a motile and a sessile life style in *S. Typhimurium*.

RESULTS

CsrA regulates steady state levels of transcripts encoding GGDEF, GGDEF-EAL and EAL domain proteins in *S. Typhimurium*. CsrA regulates GGDEF/EAL domain proteins in *E. coli* by affecting their mRNA steady state levels (Jonas *et al.*, 2008). Since *S. Typhimurium* lacks orthologues of most of the CsrA regulated GGDEF/EAL genes in *E. coli*, we hypothesised that CsrA might control the expression of other GGDEF/EAL domain proteins in *Salmonella*. To identify such genes in *S. Typhimurium* UMR1, we analysed the effect of a *csrA* mutation on the mRNA steady

state levels of all 20 genes that encode GGDEF, EAL or GGDEF-EAL domain proteins by quantitative Real-Time RT-PCR. This systematic screen led to the identification of eight genes whose mRNA levels were altered in the *csrA* mutant MAE125 compared to the wild type, when grown as liquid cultures at 37 °C to early stationary phase. Among these were two genes encoding GGDEF proteins (*STM1987*, *STM4551*), two genes encoding GGDEF-EAL domain proteins (*STM1703*, *STM3375*) as well as four genes encoding the EAL domain proteins *STM3611*, *STM1827*, *STM1344* and *STM1697* (Table 4-1). These genes have been phenotypically characterized in previous studies and most of them have been assigned to functions in the regulation of biofilm formation, motility and virulence (Table 4-1). Our data show that the *csrA* mutation caused a significant increase (3 to 7 fold) in the mRNA levels of *STM1987*, *STM1703*, *STM3375*, *STM1827* and *STM1344* (Fig. 4-1). Also the transcript levels of *STM4551* and *STM1697* were elevated in the *csrA* mutant compared to the wild type, albeit less strongly (1.6 to 1.8 fold). *STM3611* (also known as *yhjH*), encoding an active PDE (Simm *et al.*, 2004), was the only gene which showed a drastic decrease in mRNA steady state levels (>10 fold) in the *csrA* mutant. Ectopic *csrA* expression from pBAD*csrA* (pCsrA) fully complemented the effect of the *csrA* mutation for all genes that were upregulated in the *csrA* mutant. Expression of *STM3611* was partially restored (to approx. 45 % of wt mRNA levels) by pCsrA. Altogether, these data demonstrate that CsrA down- or upregulates the mRNA steady state level of *STM1987*, *STM4551*, *STM1703*, *STM3375*, *STM3611*, *STM1827*, *STM1344* and *STM1697* in *S. Typhimurium*. Although we did not observe significant changes in the mRNA levels for the remaining 12 genes encoding GGDEF, GGDEF-EAL or EAL domain proteins in *Salmonella* (data not shown), we

cannot rule out that CsrA affects the expression of these genes under different growth conditions or that potential changes in the half-lives of these mRNAs in the *csrA* mutant are compensated by unknown homeostatic mechanisms.

Potential CsrA binding sites in the 5' untranslated leader sequences. CsrA is known to regulate gene expression by binding to specific sites in the 5' untranslated regions (UTRs) of mRNA targets and thereby to affect mRNA steady state levels (Wang *et al.*, 2005, Wei *et al.*, 2001). Previous studies determined an optimal site [5'-(A/U)CAGGA-G(U/A)-3'] for high affinity CsrA/RsmA binding (Schubert *et al.*, 2007, Valverde *et al.*, 2004, Dubey *et al.*, 2005). However, the key feature that is recognized by CsrA in *E. coli* RNAs (*pgaA*, *cstA*, *glgC*, *hfq*, *ydeH*, *ycdT*, *sepL*, *grlR*, *csrB* and *csrC*) is the trinucleotide motif GGA, which is preferentially but not necessarily present in the loops of hairpin structures (Wang *et al.*, 2005, Dubey *et al.*, 2003, Baker *et al.*, 2002, Baker *et al.*, 2007, Jonas *et al.*, 2008, Weilbacher *et al.*, 2003, Liu *et al.*, 1997, Bhatt *et al.*, 2009a). We determined the 5' end of the transcripts, which were regulated by CsrA, and analysed the 5'UTRs for the presence of GGA triplets, the most invariant element of the CsrA binding site. The 5'UTRs of *STM1987*, *STM3375*, *STM1703*, *STM3611*, *STM1344* and *STM1697* contained at least one (*STM1703*) and at most 11 (*STM1987*) GGA motifs (Table 4-2), raising the possibility that CsrA directly interacts with the transcripts corresponding to these genes. No GGA triplets were present in the 5'UTRs of the transcripts of *STM1827* and *STM4551* (Table 4-2). Noticeably, *STM1987*, *STM4551*, *STM1703*, *STM3375*, *STM3611*, *STM1827*, *STM1344* and *STM1697* are not located in operons and, thus, possess their own promoters and 5'UTRs (S. 1). Likewise, most of the

other genes encoding GGDEF/EAL proteins in *Salmonella* are stand-alone genes that are not clustered together with other functionally related genes (unpublished observation).

CsrA binds specifically to untranslated mRNA leaders of *STM1987*, *STM3375*, *STM3611*, *STM1344* and *STM1697*. To determine whether CsrA directly interacts with the transcripts of the eight GGDEF/EAL genes found to be regulated by CsrA in *Salmonella*, gel-mobility shift assays were performed with CsrA protein, purified as previously described (Mercante *et al.*, 2006), and *in vitro* synthesized transcripts, comprising the entire untranslated leader and a small part of the coding region, respectively: *STM1987* (374 nt, 3 nt), *STM4551* (109 nt, 3 nt), *STM3375* (322 nt, 3 nt), *STM1703* (95 nt, 3 nt), *STM3611* (39 nt, 10 nt), *STM1827* (42 nt, 38 nt), *STM1344* (133 nt, 11 nt) and *STM1697* (65 nt, 3 nt). CsrA binding to the transcripts of *STM1987*, *STM3375*, *STM3611*, *STM1344* and *STM1697* was detected as distinctly shifted bands in native gels (Fig. 4-2A). No shifts were detected for *STM1703* and *STM4551* (S. 2A), suggesting that CsrA regulates these genes by an indirect mechanism or requires additional factors that are necessary for an interaction. Consistent with the gel-shift data, no potential binding site for CsrA was detected in the 5' leader of *STM4551* (Table 4-2). The leader of *STM1703* contained one GGA motif. However, most previously identified direct CsrA targets in *E. coli* contain at least two binding sites (Mercante *et al.*, 2009). Although a shifted band was seen for *STM1827* at high CsrA concentrations, significant amounts of the free transcript remained unbound (S. 2A). In the 5'UTR of *STM1827* no GGA motifs were found. Thus, it is possible that CsrA interaction with the *STM1827* transcript may not be biologically relevant, although we cannot completely exclude this

possibility to this date. We also cannot rule out that CsrA interacts with other regions than the 5'UTRs of the transcripts of *STM4551*, *STM1703* and *STM1827*.

More than one shifted complex was detected for *STM1987*, *STM3375*, *STM1344* and *STM1697* (Fig. 4-2A), suggesting that two or more CsrA proteins were bound to each transcript, although the stoichiometry of binding was not experimentally determined. In contrast, *STM3611* formed only one shifted complex (Fig. 4-2A). A nonlinear least-squares analysis of these CsrA binding data yielded apparent K_d values of 53 ± 10 nM for *STM1987*, 34 ± 7 nM for *STM3375*, 119 ± 8 nM for *STM3611*, 58 ± 5 nM for *STM1344* and 33 ± 3 nM for *STM1697*. These binding constants are comparable to the affinities previously measured for the interactions between CsrA and the *E. coli* mRNA targets *glgC* (39 nM), *cstA* (40 nM), *pgaA* (22 nM), *hfq* (38 nM) and *sepL* (23 nM) (Dubey *et al.*, 2003, Baker *et al.*, 2007, Baker *et al.*, 2002, Wang *et al.*, 2005, Bhatt *et al.*, 2009a). In contrast, CsrA binding to the transcripts of *ycdT*, *ydeH* ($K_{ds} \approx 2.5$ nM) and *grlR* ($K_d \approx 6$ nM) was stronger (Bhatt *et al.*, 2009a, Jonas *et al.*, 2008).

The specificity of the CsrA-RNA interactions was investigated by performing competition experiments with specific (*STM1987*, *STM3375*, *STM3611*, *STM1344*, *STM1697* and *RNA10-2BS*) and non-specific (*phoB* 5' untranslated region from *E. coli* K-12) unlabelled RNA competitors. Unlabelled *STM1987*, *STM3375*, *STM1344* and *STM1697* RNAs, respectively, were able to compete for CsrA binding with the corresponding labelled transcripts while *phoB* RNA did not compete (Fig. 4-2B, S. 2B). Unlabelled *STM3611* RNA exhibited complex interactions (Fig. 4-2B). As the concentration of this RNA was increased, slower migrating bands were observed, the major species of which was also seen in the absence of CsrA (last lane), strongly

suggesting the formation of complexes between the labelled *STM3611* RNA, unlabelled *STM3611* RNA and CsrA. Thus, to determine binding specificity of *STM3611*, unlabelled RNA10-2BS, which contains two optimal CsrA binding sites (Mercante *et al.*, 2009) was used as a specific competitor for *STM3611* RNA. RNA10-2BS was able to compete for CsrA binding without the formation of novel shifted species, while unlabelled *phoB* RNA did not compete with the *STM3611*-CsrA interaction (Fig. 4-2B). Altogether, these results indicate that CsrA binds specifically and with high affinity to *STM1987*, *STM3375*, *STM1344*, *STM1697* and *STM3611* RNA.

Indirect regulation of *STM3611* through the FlhDC/FliA cascade. The mRNA level of *STM3611* was drastically (>10 fold) downregulated in the *csrA* mutant compared to the wild type (Fig. 4-1). Consistent with this finding, the level of STM3611 protein was strongly decreased in the *csrA* mutant as observed by Western Blot analysis (Fig. 4-3A). *STM3611* encodes a PDE, which positively controls flagella function and has a negative effect on the production of the *Salmonella* biofilm matrix components curli and cellulose (Simm *et al.*, 2004, Simm *et al.*, 2007). *STM3611* is under the control of the flagella sigma factor FliA (Ko and Park, 2000, Frye *et al.*, 2006, Wang *et al.*, 2004, Claret *et al.*, 2007). *fliA*, in turn is transcribed from a flagella gene class II promoter, which requires the master regulator of flagella synthesis, FlhDC (class I) for its activation (Chevance and Hughes, 2008).

E. coli and *S. Typhimurium* *csrA* mutants lack flagella and are non-motile (Lawhon *et al.*, 2003, Wei *et al.*, 2001). Furthermore, in *E. coli* CsrA was shown to control flagella synthesis by binding to and stabilizing *flhDC* mRNA (Wei *et al.*, 2001). In *S. Typhimurium*, a microarray-based study revealed that genes belonging to the *flhDC*

regulon were strongly downregulated in a *csrA* mutant (Lawhon *et al.*, 2003). We found the mRNA levels of *flhDC*, *fliA* and genes belonging to the FliA regulon to be significantly decreased in the *csrA* mutant MAE125 compared to the wild type (Fig. 4-3B). Among these genes was also *STM1798* (*ycgR*), encoding a PilZ domain containing c-di-GMP receptor protein (Ryjenkov *et al.*, 2006), which has previously been shown to be co-regulated with *STM3611* (Ko and Park, 2000, Frye *et al.*, 2006, Wang *et al.*, 2004, Claret *et al.*, 2007).

As we considered it likely that the strong effect of CsrA on the mRNA levels of *STM3611* was mediated, at least partly, by the indirect regulation of *STM3611* through FlhDC and FliA, we attempted to complement the *csrA* mutation with plasmid-borne expression of *fliA* and *flhDC*, respectively. Ectopic expression of *fliA* from pBADfliA in the *csrA* mutant led to strongly elevated mRNA levels of both *STM3611* and *STM1798* (> 5 fold compared to wt) (Fig. 4-3C). We explain this result with the fact that the *csrA* mutant is deficient in the expression of the anti-sigma factor *flgM*, which is co-transcribed with *fliA* and counteracts FliA's activity in the wild type background (Chevance and Hughes, 2008). Ectopic expression of *flhDC* from pBADflhDC in the *csrA* mutant led only to a partial restoration of *STM3611* mRNA levels (approx. 60 % of wt), but to a complete restoration of *STM1798* transcript levels (approx. 105 % of wt) (Fig. 4-3D).

Furthermore, analysis of the swimming behaviour of the bacteria revealed that plasmid-borne expression of *flhDC* only partly restored the swimming defect of a *csrA* mutant (Fig. 4-3E). In contrast, expression of plasmid-borne *csrA* from pBADcsrA enabled the *csrA* mutant to swim in motility agar as the wild type. Overexpression of *fliA*

did not restore the swimming ability in the *csrA* mutant, which is in agreement with the model that the other FlhDC regulated class II genes, which assemble the hook-basal body of flagella (Chevance and Hughes, 2008), are shut down in the *csrA* mutant.

Altogether, our data suggest that CsrA controls the flagella cascade by regulating *flhDC*, which results in the indirect upregulation of *STM3611*. Our data also indicate that CsrA does not exclusively regulate the flagella signalling hierarchy and *STM3611* through *flhDC*, but also affects additional pathways.

Direct regulation of *STM3611* by CsrA. Gel-shift analysis revealed that CsrA specifically interacted with the transcript of *STM3611* (Fig. 4-2A,B), suggesting that in addition to the indirect regulation through FlhDC/FliA CsrA might also regulate *STM3611* mRNA stability. We noted that the leader of *STM3611* contains two GGA motifs (Table 4-2), one of which seems to overlap the Shine-Dalgarno (SD) sequence, at which ribosome binding occurs. Previously identified CsrA mRNA targets in *E. coli*, which contain one CsrA binding site at the SD site and another one further upstream, have been demonstrated to be destabilized by CsrA (Mercante *et al.*, 2009). However, our results show that in a *fliA* deficient background a mutation in *csrA* led to a further reduction in *STM3611* mRNA levels (Fig. 4-4A), suggesting that binding of CsrA might have a stabilizing effect on *STM3611* mRNA levels, independently of *fliA*. In contrast, the mRNA levels of *STM1798*, whose transcript did not interact with CsrA as determined by gel-mobility shift analysis (S. 2A), were the same in the *fliA* mutant and the *csrA fliA* double mutant (Fig. 4-4A).

The regulation of *flhDC* by CsrA in *E. coli* has so far been the only example, in which binding of CsrA to a transcript resulted in mRNA stabilization (Wei *et al.*, 2001).

It is possible that CsrA-mediated activation processes require the formation of higher order RNA structural alterations that involve CsrA binding to additional uncharacterized sites in the transcript. However, to this date no molecular model exists for CsrA-mediated activation. Our data indicate that CsrA upregulates *STM3611* expression by activating its transcription through the FlhDC/FliA cascade, as well as by directly interacting with *STM3611* transcript (Fig. 4-4B).

Indirect regulation of STM3611 through STM1344. Besides *STM3611*, CsrA was found to strongly alter the mRNA and protein levels of another EAL domain protein, STM1344 (Fig. 4-1, Fig. 4-5A). In contrast to *STM3611* and other conventional EAL domain proteins, STM1344 lacks activity as a c-di-GMP specific PDE and displays phenotypes, which are more typical for DGCs: the upregulation of biofilm behaviour and the downregulation of motility (Simm *et al.*, 2009). Furthermore, STM1344 exerts its effect on biofilm behaviour through the PDEs *STM3611* and *STM1703*, which are upregulated in the *STM1344* mutant (Simm *et al.*, 2009). In another parallel study *STM1344* (also called YdiV) was identified as a negative regulator of flagella gene expression and it was suggested that STM1344 acts on post class I genes (Wozniak *et al.*, 2008). In agreement with these previous studies, we found that a mutation in *STM1344* caused an upregulation in *STM3611* mRNA levels (Fig. 4-5B). Furthermore, the transcript levels of *STM1798* and *fliA* were increased in the *STM1344* mutant to similar extents, suggesting that STM1344 might regulate *STM3611* expression through *fliA*. A similar upregulation of *STM3611*, *STM1798* and *fliA* was detected in a *csrA STM1344* double mutant (Fig. 4-5C), which is in agreement with our model that CsrA acts upstream of STM1344.

The suggested sequential regulation of *STM3611* by *fliA* and *STM1344* was confirmed by additional studies, in which the ability of *Salmonella* to produce the biofilm matrix components curli and cellulose was used as a read-out. Curli and cellulose production can be conveniently visualized on Congo Red (CR) agar plates, on which colonies expressing these surface structures appear as red, dry and rough (rdar) and those that lack them as smooth and white (saw) (Romling, 2005). Under biofilm-inducing conditions (28 °C, LB agar plates without salt), the phosphodiesterase *STM3611* was found to negatively affect rdar morphotype expression (Simm *et al.*, 2007). Specifically, a mutant in *STM3611* shows a more pronounced rdar phenotype on CR plates than the wild type and the protein level of CsgD, the major activator of curli and cellulose synthesis, is upregulated (Simm *et al.*, 2007). Previous results also revealed that a mutation in *STM1344* downregulates *csgD* expression through *STM3611*, resulting in a reduced production of curli and cellulose (Simm *et al.*, 2009). Our data show that, similar to the *STM3611* deletion strain, a mutant in *fliA* displayed elevated CsgD levels and enhanced rdar morphotype expression compared to the wild type (Fig. 4-5D). The same phenotype was also observed in a *STM1344 fliA* double mutant, confirming our model that *STM1344* acts upstream of *FliA* and thereby regulates the PDE *STM3611*, which in turn positively controls motility behaviour and has a negative impact on the production of biofilm matrix components.

In summary, these data show that CsrA regulates the levels of *STM3611* by an additional pathway, involving the direct regulation of *STM1344*, which in turn affects *STM3611* by interfering with the flagella cascade upstream of *fliA* (Fig. 4-5E). Altogether these data indicate that CsrA controls the PDE *STM3611* by at least three distinct

pathways: the indirect regulation through *flhDC*, the direct regulation of its mRNA level and the indirect regulation through *STM1344* (Fig. 4-5E). We suggest that this multi-layer control allows CsrA to precisely regulate the activity of STM3611 and, hence, the switch between motility and biofilm behaviour.

DISCUSSION

The transition between a sessile and a motile life-style requires the complex integration of the pathways that regulate either bacterial behaviour. The present study describes the tight interplay between the Csr, c-di-GMP and motility systems in *S. Typhimurium*. In a recent study the regulation of c-di-GMP signalling by CsrA was investigated in *E. coli* (Jonas *et al.*, 2008). However, the interconnection between Csr and c-di-GMP signalling differs substantially between *E. coli* and *Salmonella*. This suggests that the utilization of conserved regulatory systems is highly adaptable and can vary between closely related species.

CsrA-mediated downregulation of the DGCs STM1987 and STM4551.

Previous studies revealed that CsrA promotes motility and inhibits biofilm-associated phenotypes (Wang *et al.*, 2005, Wei *et al.*, 2001, Jonas *et al.*, 2008, Jackson *et al.*, 2002, Romeo, 1998). In agreement, CsrA was found to directly or indirectly downregulate the c-di-GMP producing enzymes STM1987 and STM4551, respectively, in *S. Typhimurium* (Figs. 4-1 and 4-2). Under certain growth conditions STM1987 promotes the synthesis of the biofilm polysaccharide cellulose (Garcia *et al.*, 2004, Solano *et al.*, 2009) and thus acts as an activator of biofilm formation. STM4551 has recently been shown to possess DGC activity, but it also appeared to act by a c-di-GMP-independent mechanism on

diverse phenotypes (Solano *et al.*, 2009). In *E. coli* CsrA downregulates the two DGCs YdeH and YcdT (Jonas *et al.*, 2008), which are distinct from STM4551 and STM1987. Similar to STM1987, YdeH promotes the synthesis of a biofilm polysaccharide by a c-di-GMP dependent mechanism (Boehm *et al.*, 2009). However, instead of cellulose, which is not produced by *E. coli* K12, YdeH controls production of the polysaccharide PGA (Boehm *et al.*, 2009).

Complex regulation of the PDE STM3611 and the motility cascade. While CsrA inhibits c-di-GMP synthesis by downregulating STM1987 and STM4551, it upregulates the PDE STM3611 and thus promotes the degradation of c-di-GMP (Simm *et al.*, 2004, Simm *et al.*, 2007). STM3611 is suggested to influence the functionality of the flagella motor by degrading a local pool of c-di-GMP (Wolfe and Visick, 2008, Romling and Amikam, 2006). Under conditions when STM3611 is inactive, c-di-GMP accumulates and presumably binds to the receptor protein STM1798, containing a PilZ domain (Ryjenkov *et al.*, 2006). The resulting c-di-GMP-STM1798 complex was suggested to negatively affect motor function (Wolfe and Visick, 2008, Romling and Amikam, 2006). In addition, STM3611 inhibits biofilm behaviour by negatively regulating the expression of *csgD* by a c-di-GMP dependent mechanism (Simm *et al.*, 2007). Thus, by regulating STM3611 CsrA can reciprocally act on motility and biofilm behaviours.

Notably, the regulation of STM3611 by CsrA occurred at multiple levels: by two indirect pathways involving FlhDC (Fig. 4-3) and STM1344 (Fig. 4-5), respectively, and by a direct, presumably post-transcriptional mechanism (Figs. 4-2 and 4-4). This three-tiered regulatory circuitry must permit precise control of the levels of the PDE STM3611.

Furthermore, these results illustrate, for the first time, that CsrA controls the motility cascade at multiple levels (*flhDC* - class I, *STM1344* - post-class I, *STM3611* - class III) in the signalling hierarchy. We suggest that this complex control enables CsrA to coordinate flagella synthesis with flagella function. The feed-forward arrangement that directly regulates *STM3611* might allow a rapid onset of the flagella motor, under conditions that favour motility. It is likely that CsrA also controls the expression of the orthologue of *STM3611* in *E. coli* (YhjH), although this has not been experimentally demonstrated.

Noticeably, the mRNA levels of two other PDEs, *STM1827* and *STM1703*, were downregulated by CsrA (Fig. 4-1), probably by indirect mechanisms. Both *STM1827* and *STM1703* have previously been shown to degrade c-di-GMP and thereby to downregulate *csg* expression (Simm *et al.*, 2007).

Regulation of unconventional GGDEF/EAL domain proteins. CsrA was also found to control GGDEF and/or EAL domain proteins that have apparently lost the ability to metabolize c-di-GMP and have instead evolved alternative functions. The EAL-domain protein *STM1344*, which was directly downregulated by CsrA (Figs. 4-1, 4-2 and 4-5), contains a degenerate sequence motif in its EAL domain and is inactive in the degradation or binding of c-di-GMP (Simm *et al.*, 2009). *STM1344* negatively controls the flagella cascade by an unknown mechanism upstream of *fliA* (present study) and downstream of *flhDC* transcription (Wozniak *et al.*, 2008). The indirect regulation of the PDE *STM3611* by *STM1344* results in the downregulation of motility and the upregulation of biofilm matrix production. *STM1344* also controls the PDE *STM1703* (Simm *et al.*, 2009), which negatively regulates *csg* expression and, thus, biofilm

behaviour (Simm *et al.*, 2007) (Fig. 4-6). Hence, despite its degenerate EAL domain, STM1344 still maintains a function in the regulation of c-di-GMP metabolism.

Another EAL domain protein, STM1697, shows high sequence similarity to STM1344, and its mRNA level was directly regulated by CsrA (Figs. 4-1 and 4-2). Similar to STM1344, STM1697 does not contain the highly conserved sequence motifs (e.g. EXL, DDFGTG), which have previously been suggested to be critical for PDE activity (Schmidt *et al.*, 2005, Rao *et al.*, 2009), suggesting that STM1697 has no PDE activity. A mutant in STM1697 does not show a distinct phenotype in motility or biofilm behaviour (Simm *et al.*, 2007). However, data from another on-going study suggest that the protein might be involved in the regulation of virulence phenotypes (Lamprokostopoulou and Römling, unpublished).

CsrA also regulated the expression of the unorthodox GGDEF-EAL protein STM3375 (Fig. 4-1, Fig. 4-2). The *E. coli* STM3375 orthologue CsrD (YhdA) is itself a component of the Csr system (Suzuki *et al.*, 2006, Jonas *et al.*, 2006), which facilitates RNaseE-dependent degradation of the sRNAs CsrB and CsrC, the molecular antagonists of CsrA (Suzuki *et al.*, 2006). Thus, although not directly involved in the synthesis or degradation of c-di-GMP, CsrD controls the activity of CsrA, a global regulator of GGDEF and EAL domain proteins and c-di-GMP levels (Jonas *et al.*, 2008). STM3375 and *E. coli* CsrD are highly similar proteins. They contain identical degenerate GGDEF and EAL motif signatures, as well as an identical sequence in the EAL domain that is unique to putative CsrD homologues (R579-TENQLLVQ-S588) and is required for activity of the *E. coli* protein (Suzuki *et al.*, 2006). This suggests that these proteins function similarly. The finding that CsrA controls the expression of *csrD* (Suzuki *et al.*,

2006, Jonas *et al.*, 2008) and *STM3375* indicates that it regulates its own activity through an autoregulatory loop in both of these species.

Signal integration into the Csr/c-di-GMP system. CsrA activity is also controlled by the BarA-SirA (BarA-UvrY in *E. coli*) two-component system (Fig. 4-6), which activates the transcription of *csrB* and *csrC* (Altier *et al.*, 2000b, Teplitski *et al.*, 2003, Weilbacher *et al.*, 2003, Suzuki *et al.*, 2002). The chemical nature of the signal acting on the BarA sensor and its orthologues in other bacteria has not been identified yet. However, studies in *E. coli* suggest that the metabolic status of the cells and the external pH regulate the activity of the two-component system (Jonas and Melefors, 2009a, Pernestig *et al.*, 2003, Mondragon *et al.*, 2006). In *Salmonella*, the presence of bile salts seems to affect BarA-SirA dependent responses (Prouty and Gunn, 2000) and results from another study have shown that short chain fatty acids affect CsrA mediated phenotypes in a pathway involving SirA, but probably not BarA (Lawhon *et al.*, 2002). Transcription of *csrB* and *csrC* somehow also requires upstream activation by CsrA, indicative of an additional feedback loop (Fig. 4-6) and strongly suggestive of a homeostatic mechanism controlling CsrA activity (Gudapaty *et al.*, 2001, Suzuki *et al.*, 2002, Weilbacher *et al.*, 2003, Jonas and Melefors, 2009a). The tight regulation of CsrA activity by BarA-SirA, CsrD and CsrA itself through the Csr sRNAs ensures that downstream targets of CsrA are precisely coordinated in response to multiple input signals.

Central role of CsrA in the mediation of life-style switches. Our data illustrate that the regulation of GGDEF and EAL domain proteins enables CsrA to tightly control the switch between sessility and motility at multiple levels (Fig. 4-6). In general, CsrA

activates motility pathways and inhibits the production of biofilm factors. Notably however, in contrast to a *csrA* mutant in *E. coli*, in which biofilm formation is strongly enhanced (Jackson *et al.*, 2002), a *S. Typhimurium csrA* mutant does not show increased adherence or rdar morphotype expression as would be expected (Teplitski *et al.*, 2006)(our unpublished observations). Instead, colonies of the *csrA* mutant have a mucoid and smooth colony appearance (our unpublished observations). Although the molecular basis of this observation remains unknown, it indicates a complex role of CsrA in the regulation of cell surface / extracellular phenotypes in *Salmonella*.

Finally, CsrA plays an important role in the regulation of *Salmonella* virulence genes (Altier *et al.*, 2000a, Lawhon *et al.*, 2003). Likewise, c-di-GMP has been recently found to affect virulence properties in *Salmonella* (Lamprokostopoulou *et al.*, 2009). In fact, several of the CsrA-regulated genes studied herein affect virulence phenotypes, including STM1344, STM4551 and STM1697 (Hisert *et al.*, 2005, Solano *et al.*, 2009). Thus it is likely, that the regulation of GGDEF and/or EAL domain proteins allows CsrA not only to control motility and sessility, but also a range of other bacterial behaviours that are important for *Salmonella* to adapt to changing environments.

MATERIALS AND METHODS

Bacterial strains and growth conditions. All strains used in this study are listed in Table 4-1. Chromosomal mutations were generated using the Datsenko method (Datsenko and Wanner, 2000). For the construction of the *csrA::kan* mutant allele, the *kan* gene was amplified from pKD4 by PCR using the primer pair CsrAKOup/CsrAKOdn (Table 4-3) and electroporated into arabinose-treated *S. Typhimurium* ATCC 14028

carrying pKD46. For the construction of the *fliA* mutant MAE1456 (UMR1 *fliA::cat*), the *cat* gene was amplified from pKD3 using the primer pair FliAKOfor/FliAKOrev and introduced by electroporation into arabinose-treated *S. Typhimurium* UMR1 carrying pKD46. Transformants were selected for the gain of kanamycin or chloramphenicol resistance, respectively, and the loss of ampicillin resistance and were verified by PCR using the appropriate control primer pairs (S. 3). To generate MAE125 (UMR1 *csrA::kan*) the *csrA::kan* allele was transferred by P22 transduction into *Salmonella Typhimurium* UMR1. For construction of the *fliA csrA* (MAE1476) and the *STM1344 csrA* (MAE1474) double mutants, the mutant alleles from MAE1456 (UMR1 *fliA::cat*) and MAE424 (UMR1 *STM1344::cat*), respectively, were transduced into the MAE125 background. For the construction of the *fliA STM1344* double mutant MAE1481, the *cat* cassette was removed from MAE1456 followed by the transduction of *STM1344::cat* into the resulting strain (MAE1463). To generate MAE1493 (UMR1 Δ *csrA STM3611*-SPA) and MAE1492 (UMR1 Δ *csrA STM1344*-SPA), the *kan* cassette from MAE125 was flipped out using the the FLP recombinase followed by the transduction of the SPA-tagged *STM1344* and *STM3611* constructs from MAE132 (UMR1 *STM1344*-SPA *kan*^r) and MAE130 (UMR1 *STM3611*-SPA *kan*^r), respectively, into the resulting strain. Bacteria were routinely grown in LB medium at 37 °C with shaking at 200 r.p.m. If necessary, arabinose (0.1 %) or antibiotics were added: ampicillin 100 $\mu\text{g ml}^{-1}$, kanamycin 50 $\mu\text{g ml}^{-1}$ and chloramphenicol 30 $\mu\text{g ml}^{-1}$.

Plasmid construction. All plasmids used in this study are listed in Table 4-1. For construction of pIRF-2 the *fliA* gene was amplified from the *S. Typhimurium* UMR1 chromosome by PCR using the primers pBAD*fliA*for and pBAD*fliA*rev (S. 3). The

resultant PCR product was cleaved with *XbaI* and *HindIII* and inserted between the corresponding sites of pBAD30, under the control of the arabinose inducible promoter P_{BAD} . Sequencing verified the integrity of the *fliA* gene.

Quantitative real-time RT PCR. RNA was sampled, treated with RNAprotect Bacterial Reagent (Qiagen) and prepared using the RNeasy Mini Kit with on-column DNA digestion (Qiagen) according to the protocol. After determination of the RNA concentrations using the NanoDrop ND-1000 UV-Vis Spectrophotometer, 1 μ g RNA was reverse transcribed in 20 μ l reactions using the High-Capacity cDNA Reverse Transcription Kit (Applied Biosystems). Primers were designed with the Primer Express Software v3.0 (Applied Biosystems). Twenty ng of template were used for the real-time PCR reaction using Power SYBR Green PCR Master Mix (Applied Biosystems). The cycling reaction was performed with an ABI 7500 Real Time PCR System (Applied Biosystems) using the standard run mode of the instrument. For detection of primer dimerization or other artefacts of amplification, dissociation curves and non-template controls were included in the real-time PCR analysis. Individual gene expression profiles were normalized against the *recA* gene or the *rrnD* gene (16S rRNA), serving as endogenous controls. All results were analysed using the 7500 SDS Software v1.3.1 (Applied Biosystems) and further prepared using Excel (Microsoft). In all experiments, the change in expression was measured relative to a calibrator, e.g. wild type, which was set to 1. The data values presented in all figures represent the mean values calculated from the results from at least three independent repetitions of the experiment. The error bars represent the standard deviations. For statistical evaluation p-values were calculated using the student t-test.

5' Rapid amplification of cDNA ends (5'RACE). The 5' ends of the transcripts of *STM1987*, *STM4551*, *STM3375*, *STM1703*, *STM3611*, *STM1827*, *STM1344*, *STM1697* and *STM1798* were determined using the 5'RACE System for Rapid Amplification of cDNA ends (v2.0 Invitrogen) according to the protocol and as previously described (Jonas *et al.*, 2008). The resulting RACE PCR products were sequenced using the Big Dye Terminator Cycle Sequencing Kit (v3.1).

RNA gel mobility shift assays. Quantitative gel mobility shift assays followed a previously published procedure (Yakhnin *et al.*, 2000). CsrA-His₆ protein was purified as described previously (Mercante *et al.*, 2006). DNA templates for generating *STM1697*, *STM1798*, and *phoB* (non-specific competitor) RNA transcripts were produced by annealing primers STM1697-T7 and GC STM1697-T7, STM1798-T7 and GC STM1798-T7, or *phoB*-T7 and GC *phoB*-T7 in TES buffer (10 mM Tris-HCl pH 8.0, 1 mM EDTA, 100 mM NaCl). DNA templates for *STM1344*, *STM1703*, *STM1827*, *STM1987*, *STM3375*, and *STM4551* were PCR-amplified from UMR1 genomic DNA using primers STM1344-F-T7 and STM1344-R-T7, STM1703-F-T7 and STM1703-R-T7, STM1827-F-T7 and STM1827-R-T7, STM1987-F-T7 and STM1987-R-T7, 3375-F1(P1)-T7 and 3375-R1(ATG)-T7 or STM4551-F-T7 and STM4551-R-T7 (S. 3). RNA was synthesized *in vitro* using the MEGAscript kit (Ambion, Austin, TX) using the annealed DNA primers (*STM1697*, *STM1798* and *phoB*) or DNA templates (*STM1344*, *STM1703*, *STM1827*, *STM1987*, *STM3375*, and *STM4551*) as templates, and RNA was gel purified. *STM3611* and RNA10-2BS RNA were synthesized by Integrated DNA Technologies (Coralville, IA). Transcripts were 5' end-labelled using T4 polynucleotide kinase and [γ -³²P]-ATP. Radiolabelled RNA was gel purified and resuspended in TE (10 mM Tris-HCl

pH 8.0, 1 mM EDTA), heated to 85°C and chilled on ice. Increasing concentrations of purified CsrA-His₆ recombinant protein were combined with 50 pM radiolabelled RNA in 10 µl of binding reactions [10 mM Tris-HCl pH 7.5, 10 mM MgCl₂, 100 mM KCl, 3.25 ng total yeast RNA, 20 mM DTT, 7.5 % glycerol, 4 U SUPERasin (Ambion, Austin, TX)] for 30 min at 37 °C to allow for CsrA–RNA complex formation. Competition assays were performed in the absence or presence of unlabelled RNA specific and non-specific competitors. Binding reactions were separated using 8-12 % native polyacrylamide gels, and radioactive bands were visualized with a Molecular Dynamics phosphorimager. Free and bound RNA species were quantified with ImageQuant Software (Molecular Dynamics), and an apparent equilibrium binding constant (K_d) was calculated for CsrA–RNA complex formation according to a previously described cooperative binding equation (Mercante *et al.*, 2006). The mean values and standard errors from at least two independent experiments were determined for each transcript. Graphpad Prism version 3.02 for Windows (San Diego, CA) software was used for calculations.

Western Blot analysis. For Western Blot analysis 5 µg of cells were harvested, resuspended in sample buffer, and heated to 95 °C for 10 min. The protein content was analysed by staining with a Coomassie blue solution (20 % methanol, 10 % acetic acid, 0.1 % Coomassie brilliant blue G). Equal amounts of protein were separated by sodium dodecyl sulphate-polyacrylamide gel electrophoresis using 15 % (for SPA tagged proteins) or 12 % (for CsgD) resolving gels and 4 % stacking gels and were transferred onto a polyvinylidene difluoride membrane (Immobilon P, Millipore). The detection of the SPA tags was done using anti-FLAG antibody (1:2000) and anti-mouse

immunoglobulin G conjugated with horseradish peroxidase (1:2000, Jackson ImmunoResearch Laboratories Inc.) as the secondary antibody. Detection of CsgD was performed as previously described (Romling *et al.*, 2000) by using the polyclonal anti-CsgD peptide antibody (1:5000) as the primary antibody and goat anti-rabbit immunoglobulin G conjugated with horseradish peroxidase (1:2000) as the secondary antibody. Chemiluminescence from the Lumi-Light WB substrate (Roche) was recorded using the LAS-1000 system (Fujifilm). The intensity of the bands was quantified using Adobe Photoshop CS3. Each experiment was repeated at least three times and representative results were chosen for display.

Motility assay. To analyse the swimming behaviour of the bacteria, 0.3 % LB agar plates supplemented with 0.1 % arabinose were inoculated with 4 μ l of overnight cultures, which were grown in LB with 0.1 % arabinose for 14 -16 h. The plates were incubated at 37 °C and the diameter of the swimming zone was measured over time. Each experiment was performed at least three times, and a representative result was chosen for display.

Congo Red binding assay. Samples of 5 μ l of an overnight culture suspended in water (to an optical density at 600 nm [OD₆₀₀] of 5) were spotted onto LB agar plates lacking NaCl and supplemented with Congo red (40 μ g ml⁻¹) and Coomassie brilliant blue (20 μ g ml⁻¹). Plates were incubated at 28°C and the development of the colony morphology and dye binding were analyzed over time.

ACKNOWLEDGEMENTS

We are grateful to Jörg Vogel for kindly providing the plasmid pAS-0081, to Fredrik Åslund for help with the construction of the *csrA* mutant MAE125, and to Karina Hentrich and Susanna Bächle for excellent technical assistance. This work was supported by grants from the Marie Curie Early Stage Research Training Fellowship of the European Community's Sixth Framework Program under Contract Number MEST-CT-2004-8475, the Swedish Research Council (621-2007-6509, to U.R.), the Carl Tryggers Stiftelse (CTS-07:306, to U.R.), the U.S. National Institutes of Health (GM059969, GM066794) and a PhD fellowship from the Higher Education Commission of Pakistan (HEC) to I.A.

REFERENCES

- Altier, C., Suyemoto, M., and Lawhon, S.D. (2000a) Regulation of *Salmonella enterica* serovar typhimurium invasion genes by *csrA*. *Infect Immun* **68**: 6790-6797.
- Altier, C., Suyemoto, M., Ruiz, A.I., Burnham, K.D., and Maurer, R. (2000b) Characterization of two novel regulatory genes affecting *Salmonella* invasion gene expression. *Mol Microbiol* **35**: 635-646.
- Babitzke, P., and Romeo, T. (2007) CsrB sRNA family: sequestration of RNA-binding regulatory proteins. *Curr Opin Microbiol* **10**: 156-163.
- Baker, C.S., Morozov, I., Suzuki, K., Romeo, T., and Babitzke, P. (2002) CsrA regulates glycogen biosynthesis by preventing translation of *glgC* in *Escherichia coli*. *Mol Microbiol* **44**: 1599-1610.

- Baker, C.S., Eory, L.A., Yakhnin, H., Mercante, J., Romeo, T., and Babitzke, P. (2007) CsrA inhibits translation initiation of *Escherichia coli* hfq by binding to a single site overlapping the Shine-Dalgarno sequence. *J Bacteriol* **189**: 5472-5481.
- Bhatt, S., Edwards, A.N., Nguyen, H.T., Merlin, D., Romeo, T., and Kalman, D. (2009) The RNA binding protein CsrA is a pleiotropic regulator of the LEE pathogenicity island of enteropathogenic *Escherichia coli*. *Infect Immun.*
- Boehm, A., Steiner, S., Zaehring, F., Casanova, A., Hamburger, F., Ritz, D. *et al.* (2009) Second messenger signalling governs *Escherichia coli* biofilm induction upon ribosomal stress. *Mol Microbiol* **72**: 1500-1516.
- Chevance, F.F., and Hughes, K.T. (2008) Coordinating assembly of a bacterial macromolecular machine. *Nat Rev Microbiol* **6**: 455-465.
- Christen, M., Christen, B., Folcher, M., Schauerte, A., and Jenal, U. (2005) Identification and characterization of a cyclic di-GMP-specific phosphodiesterase and its allosteric control by GTP. *J Biol Chem* **280**: 30829-30837.
- Claret, L., Miquel, S., Vieille, N., Ryjenkov, D.A., Gomelsky, M., and Darfeuille-Michaud, A. (2007) The flagellar sigma factor FliA regulates adhesion and invasion of Crohn disease-associated *Escherichia coli* via a cyclic dimeric GMP-dependent pathway. *J Biol Chem* **282**: 33275-33283.
- Cotter, P.A., and Stibitz, S. (2007) c-di-GMP-mediated regulation of virulence and biofilm formation. *Curr Opin Microbiol* **10**: 17-23.
- Datsenko, K.A., and Wanner, B.L. (2000) One-step inactivation of chromosomal genes in *Escherichia coli* K-12 using PCR products. *Proc Natl Acad Sci U S A* **97**: 6640-6645.

- Dubey, A.K., Baker, C.S., Romeo, T., and Babitzke, P. (2005) RNA sequence and secondary structure participate in high-affinity CsrA-RNA interaction. *Rna* **11**: 1579-1587.
- Dubey, A.K., Baker, C.S., Suzuki, K., Jones, A.D., Pandit, P., Romeo, T., and Babitzke, P. (2003) CsrA regulates translation of the Escherichia coli carbon starvation gene, cstA, by blocking ribosome access to the cstA transcript. *J Bacteriol* **185**: 4450-4460.
- Frye, J., Karlinsey, J.E., Felise, H.R., Marzolf, B., Dowidar, N., McClelland, M., and Hughes, K.T. (2006) Identification of new flagellar genes of Salmonella enterica serovar Typhimurium. *J Bacteriol* **188**: 2233-2243.
- Galperin, M.Y. (2004) Bacterial signal transduction network in a genomic perspective. *Environ Microbiol* **6**: 552-567.
- Galperin, M.Y., Nikolskaya, A.N., and Koonin, E.V. (2001) Novel domains of the prokaryotic two-component signal transduction systems. *FEMS Microbiol Lett* **203**: 11-21.
- Garcia, B., Latasa, C., Solano, C., Garcia-del Portillo, F., Gamazo, C., and Lasa, I. (2004) Role of the GGDEF protein family in Salmonella cellulose biosynthesis and biofilm formation. *Mol Microbiol* **54**: 264-277.
- Gudapaty, S., Suzuki, K., Wang, X., Babitzke, P., and Romeo, T. (2001) Regulatory interactions of Csr components: the RNA binding protein CsrA activates csrB transcription in Escherichia coli. *J Bacteriol* **183**: 6017-6027.

- Guzman, L.M., Belin, D., Carson, M.J., and Beckwith, J. (1995) Tight regulation, modulation, and high-level expression by vectors containing the arabinose PBAD promoter. *J Bacteriol* **177**: 4121-4130.
- Hengge, R. (2009) Principles of c-di-GMP signalling in bacteria. *Nat Rev Microbiol* **7**: 263-273.
- Hisert, K.B., MacCoss, M., Shiloh, M.U., Darwin, K.H., Singh, S., Jones, R.A. *et al.* (2005) A glutamate-alanine-leucine (EAL) domain protein of Salmonella controls bacterial survival in mice, antioxidant defence and killing of macrophages: role of cyclic diGMP. *Mol Microbiol* **56**: 1234-1245.
- Itoh, Y., Rice, J.D., Goller, C., Pannuri, A., Taylor, J., Meisner, J. *et al.* (2008) Roles of pgaABCD genes in synthesis, modification, and export of the Escherichia coli biofilm adhesin poly-beta-1,6-N-acetyl-D-glucosamine. *J Bacteriol* **190**: 3670-3680.
- Jackson, D.W., Suzuki, K., Oakford, L., Simecka, J.W., Hart, M.E., and Romeo, T. (2002) Biofilm formation and dispersal under the influence of the global regulator CsrA of Escherichia coli. *J Bacteriol* **184**: 290-301.
- Jonas, K., and Melefors, O. (2009) The Escherichia coli CsrB and CsrC small RNAs are strongly induced during growth in nutrient-poor medium. *FEMS Microbiol Lett* **297**: 80-86.
- Jonas, K., Melefors, O., and Romling, U. (2009) Regulation of c-di-GMP metabolism in biofilms. *Future Microbiol* **4**: 341-358.

- Jonas, K., Tomenius, H., Romling, U., Georgellis, D., and Melefors, O. (2006) Identification of YhdA as a regulator of the Escherichia coli carbon storage regulation system. *FEMS Microbiol Lett* **264**: 232-237.
- Jonas, K., Edwards, A.N., Simm, R., Romeo, T., Romling, U., and Melefors, O. (2008) The RNA binding protein CsrA controls cyclic di-GMP metabolism by directly regulating the expression of GGDEF proteins. *Mol Microbiol* **70**: 236-257.
- Kader, A., Simm, R., Gerstel, U., Morr, M., and Romling, U. (2006) Hierarchical involvement of various GGDEF domain proteins in rdar morphotype development of Salmonella enterica serovar Typhimurium. *Mol Microbiol* **60**: 602-616.
- Ko, M., and Park, C. (2000) Two novel flagellar components and H-NS are involved in the motor function of Escherichia coli. *J Mol Biol* **303**: 371-382.
- Lamprokostopoulou, A., Monteiro, C., Rhen, M., and Romling, U. (2009) Cyclic di-GMP signalling controls virulence properties of Salmonella enterica serovar Typhimurium at the mucosal lining. *Environ Microbiol*.
- Lapouge, K., Schubert, M., Allain, F.H., and Haas, D. (2008) Gac/Rsm signal transduction pathway of gamma-proteobacteria: from RNA recognition to regulation of social behaviour. *Mol Microbiol* **67**: 241-253.
- Lawhon, S.D., Maurer, R., Suyemoto, M., and Altier, C. (2002) Intestinal short-chain fatty acids alter Salmonella typhimurium invasion gene expression and virulence through BarA/SirA. *Mol Microbiol* **46**: 1451-1464.
- Lawhon, S.D., Frye, J.G., Suyemoto, M., Porwollik, S., McClelland, M., and Altier, C. (2003) Global regulation by CsrA in Salmonella typhimurium. *Mol Microbiol* **48**: 1633-1645.

- Liu, M.Y., Gui, G., Wei, B., Preston, J.F., 3rd, Oakford, L., Yuksel, U. *et al.* (1997) The RNA molecule CsrB binds to the global regulatory protein CsrA and antagonizes its activity in *Escherichia coli*. *J Biol Chem* **272**: 17502-17510.
- Lucchetti-Miganeh, C., Burrowes, E., Baysse, C., and Ermel, G. (2008) The post-transcriptional regulator CsrA plays a central role in the adaptation of bacterial pathogens to different stages of infection in animal hosts. *Microbiology* **154**: 16-29.
- Mercante, J., Suzuki, K., Cheng, X., Babitzke, P., and Romeo, T. (2006) Comprehensive alanine-scanning mutagenesis of *Escherichia coli* CsrA defines two subdomains of critical functional importance. *J Biol Chem* **281**: 31832-31842.
- Mercante, J., Edwards, A.N., Dubey, A.K., Babitzke, P., and Romeo, T. (2009) Molecular geometry of CsrA (RsmA) binding to RNA and its implications for regulated expression. *J Mol Biol.*
- Mondragon, V., Franco, B., Jonas, K., Suzuki, K., Romeo, T., Melefors, O., and Georgellis, D. (2006) pH-dependent activation of the BarA-UvrY two-component system in *Escherichia coli*. *J Bacteriol* **188**: 8303-8306.
- Paul, R., Weiser, S., Amiot, N.C., Chan, C., Schirmer, T., Giese, B., and Jenal, U. (2004) Cell cycle-dependent dynamic localization of a bacterial response regulator with a novel di-guanylate cyclase output domain. *Genes Dev* **18**: 715-727.
- Pernestig, A.K., Georgellis, D., Romeo, T., Suzuki, K., Tomenius, H., Normark, S., and Melefors, O. (2003) The *Escherichia coli* BarA-UvrY two-component system is needed for efficient switching between glycolytic and gluconeogenic carbon sources. *J Bacteriol* **185**: 843-853.

- Prouty, A.M., and Gunn, J.S. (2000) Salmonella enterica serovar typhimurium invasion is repressed in the presence of bile. *Infect Immun* **68**: 6763-6769.
- Rao, F., Qi, Y., Chong, H.S., Kotaka, M., Li, B., Li, J. *et al.* (2009) The functional role of a conserved loop in EAL domain-based cyclic di-GMP-specific phosphodiesterase. *J Bacteriol* **191**: 4722-4731.
- Romeo, T. (1998) Global regulation by the small RNA-binding protein CsrA and the non-coding RNA molecule CsrB. *Mol Microbiol* **29**: 1321-1330.
- Romling, U. (2005) Characterization of the rdar morphotype, a multicellular behaviour in Enterobacteriaceae. *Cell Mol Life Sci* **62**: 1234-1246.
- Romling, U., and Amikam, D. (2006) Cyclic di-GMP as a second messenger. *Curr Opin Microbiol* **9**: 218-228.
- Romling, U., and Simm, R. (2009) Prevailing concepts of c-di-GMP signaling. *Contrib Microbiol* **16**: 161-181.
- Romling, U., Sierralta, W.D., Eriksson, K., and Normark, S. (1998) Multicellular and aggregative behaviour of Salmonella typhimurium strains is controlled by mutations in the agfD promoter. *Mol Microbiol* **28**: 249-264.
- Romling, U., Rohde, M., Olsen, A., Normark, S., and Reinkoster, J. (2000) AgfD, the checkpoint of multicellular and aggregative behaviour in Salmonella typhimurium regulates at least two independent pathways. *Mol Microbiol* **36**: 10-23.
- Ryan, R.P., Fouhy, Y., Lucey, J.F., Crossman, L.C., Spiro, S., He, Y.W. *et al.* (2006) Cell-cell signaling in Xanthomonas campestris involves an HD-GYP domain protein that functions in cyclic di-GMP turnover. *Proc Natl Acad Sci U S A* **103**: 6712-6717.

- Ryjenkov, D.A., Tarutina, M., Moskvina, O.V., and Gomelsky, M. (2005) Cyclic diguanylate is a ubiquitous signaling molecule in bacteria: insights into biochemistry of the GGDEF protein domain. *J Bacteriol* **187**: 1792-1798.
- Ryjenkov, D.A., Simm, R., Romling, U., and Gomelsky, M. (2006) The PilZ domain is a receptor for the second messenger c-di-GMP: the PilZ domain protein YcgR controls motility in enterobacteria. *J Biol Chem* **281**: 30310-30314.
- Schmidt, A.J., Ryjenkov, D.A., and Gomelsky, M. (2005) The ubiquitous protein domain EAL is a cyclic diguanylate-specific phosphodiesterase: enzymatically active and inactive EAL domains. *J Bacteriol* **187**: 4774-4781.
- Schubert, M., Lapouge, K., Duss, O., Oberstrass, F.C., Jelesarov, I., Haas, D., and Allain, F.H. (2007) Molecular basis of messenger RNA recognition by the specific bacterial repressing clamp RsmA/CsrA. *Nat Struct Mol Biol* **14**: 807-813.
- Simm, R., Morr, M., Kader, A., Nimtz, M., and Romling, U. (2004) GGDEF and EAL domains inversely regulate cyclic di-GMP levels and transition from sessility to motility. *Mol Microbiol* **53**: 1123-1134.
- Simm, R., Lusch, A., Kader, A., Andersson, M., and Romling, U. (2007) Role of EAL-containing proteins in multicellular behavior of *Salmonella enterica* serovar Typhimurium. *J Bacteriol* **189**: 3613-3623.
- Simm, R., Remminghorst, U., Ahmad, I., Zakikhany, K., and Romling, U. (2009) A role for the EAL-like protein STM1344 in regulation of CsgD expression and motility in *Salmonella enterica* serovar Typhimurium. *J Bacteriol* **191**: 3928-3937.

- Sittka, A., Lucchini, S., Papenfort, K., Sharma, C.M., Rolle, K., Binnewies, T.T. *et al.* (2008) Deep sequencing analysis of small noncoding RNA and mRNA targets of the global post-transcriptional regulator, Hfq. *PLoS Genet* **4**: e1000163.
- Solano, C., Garcia, B., Latasa, C., Toledo-Arana, A., Zorraquino, V., Valle, J. *et al.* (2009) Genetic reductionist approach for dissecting individual roles of GGDEF proteins within the c-di-GMP signaling network in Salmonella. *Proc Natl Acad Sci U S A* **106**: 7997-8002.
- Suzuki, K., Babitzke, P., Kushner, S.R., and Romeo, T. (2006) Identification of a novel regulatory protein (CsrD) that targets the global regulatory RNAs CsrB and CsrC for degradation by RNase E. *Genes Dev* **20**: 2605-2617.
- Suzuki, K., Wang, X., Weilbacher, T., Pernestig, A.K., Melefors, O., Georgellis, D. *et al.* (2002) Regulatory circuitry of the CsrA/CsrB and BarA/UvrY systems of Escherichia coli. *J Bacteriol* **184**: 5130-5140.
- Tamayo, R., Pratt, J.T., and Camilli, A. (2007) Roles of cyclic diguanylate in the regulation of bacterial pathogenesis. *Annu Rev Microbiol* **61**: 131-148.
- Teplitski, M., Goodier, R.I., and Ahmer, B.M. (2003) Pathways leading from BarA/SirA to motility and virulence gene expression in Salmonella. *J Bacteriol* **185**: 7257-7265.
- Teplitski, M., Al-Agely, A., and Ahmer, B.M. (2006) Contribution of the SirA regulon to biofilm formation in Salmonella enterica serovar Typhimurium. *Microbiology* **152**: 3411-3424.

- Valverde, C., Lindell, M., Wagner, E.G., and Haas, D. (2004) A repeated GGA motif is critical for the activity and stability of the riboregulator RsmY of *Pseudomonas fluorescens*. *J Biol Chem* **279**: 25066-25074.
- Wang, Q., Frye, J.G., McClelland, M., and Harshey, R.M. (2004) Gene expression patterns during swarming in *Salmonella typhimurium*: genes specific to surface growth and putative new motility and pathogenicity genes. *Mol Microbiol* **52**: 169-187.
- Wang, X., Dubey, A.K., Suzuki, K., Baker, C.S., Babitzke, P., and Romeo, T. (2005) CsrA post-transcriptionally represses pgaABCD, responsible for synthesis of a biofilm polysaccharide adhesin of *Escherichia coli*. *Mol Microbiol* **56**: 1648-1663.
- Wei, B.L., Brun-Zinkernagel, A.M., Simecka, J.W., Pruss, B.M., Babitzke, P., and Romeo, T. (2001) Positive regulation of motility and flhDC expression by the RNA-binding protein CsrA of *Escherichia coli*. *Mol Microbiol* **40**: 245-256.
- Weilbacher, T., Suzuki, K., Dubey, A.K., Wang, X., Gudapaty, S., Morozov, I. *et al.* (2003) A novel sRNA component of the carbon storage regulatory system of *Escherichia coli*. *Mol Microbiol* **48**: 657-670.
- Wolfe, A.J., and Visick, K.L. (2008) Get the message out: cyclic-Di-GMP regulates multiple levels of flagellum-based motility. *J Bacteriol* **190**: 463-475.
- Wozniak, C.E., Lee, C., and Hughes, K.T. (2008) T-POP array identifies EcnR and PefI-SrgD as novel regulators of flagellar gene expression. *J Bacteriol*.
- Yakhnin, A.V., Trimble, J.J., Chiaro, C.R., and Babitzke, P. (2000) Effects of mutations in the L-tryptophan binding pocket of the Trp RNA-binding attenuation protein of *Bacillus subtilis*. *J Biol Chem* **275**: 4519-4524.

Table 4-1. GGDEF/EAL proteins regulated by CsrA.

Protein (synonym)	Regulation by CsrA	Motif	Enzymatic activity	Reported phenotype	Reference
STM1987	negative, direct ¹	GGEEF	DGC	Upregulation of cellulose production	(Solano <i>et al.</i> , 2009, Garcia <i>et al.</i> , 2004)
STM4551	negative, indirect ¹ ?	GGDEF	DGC	Functions in motility, rdar morphotype expression, virulence	(Solano <i>et al.</i> , 2009)
STM3375 (YhdA, CsrD)	negative, direct	HRSDF, ELM	no DGC, no PDE (in <i>E. coli</i>)	Regulation of sRNAs (in <i>E. coli</i>), upregulation of motility	(Suzuki <i>et al.</i> , 2006, Simm <i>et al.</i> , 2007)
STM1703 (YciR)	negative, indirect?	GGDEF, EAL	putative PDE, DGC activity not known	Downregulation of the rdar morphotype	(Simm <i>et al.</i> , 2007, Garcia <i>et al.</i> , 2004)
STM3611 (YhjH)	positive, direct and indirect	ELL	PDE	Upregulation of motility, downregulation of the rdar morphotype	(Simm <i>et al.</i> , 2007, Simm <i>et al.</i> , 2004)
STM1827	negative, indirect?	EAL	putative PDE	Downregulation of the rdar morphotype	(Simm <i>et al.</i> , 2007)
STM1344 (YdiV)	negative, direct	EII	no PDE	Downregulation of motility, upregulation of the rdar morphotype, role in virulence	(Simm <i>et al.</i> , 2007, Simm <i>et al.</i> , 2009, Wozniak <i>et al.</i> , 2008, Hisert <i>et al.</i> , 2005)
STM1697	negative, direct	EIT	probably no PDE	Role in virulence (?)	(Lamprokostopoulou and Römling, unpublished)

¹ direct vs indirect regulation inferred from RNA-binding by CsrA to the respective transcripts as observed by gel-mobility shift assays

Table 4-2. 5' untranslated leader sequences of CsrA regulated genes.

Gene	5' UTR
STM1987	<u>UUUCAUCUGAUACAGGAGGCAGGUAUGGUCUUUUCUGUCAGUGAGGAAGUUACCGUGAAAGAGGGUG</u> GGCCCCGGAUGAUCGUCACCGGUUAUUCAGCGGA AUGGUAGAGUGUCGCUGGUAUGAUGGUUUUGG CGUAAAGCGGGAGGCAUCCAUGAGAAUGAGCUCGUGCCAGGCAAGGAAAGGCGCGUGCGGGACGAA GCCCCAUGACAAAACGCCCGGUUAAUGCCGGGCGUUUUGCUGUGGAGAAAAAGAGUCGUCGCGCUGC GACAUGCUGCUACCUGGUUAUGCCAGGAUUGAGUGGUAUCCCUUGAUGAGGUCUGGGCUACCGUAAGC CAUCAGGGGGAGUUGUAUCAUAACCAGGAGUUACCAGGGUG
STM4551	<u>GUUAACGUAAAAACAACAACACCTCGCUUAGGGCACC</u> UUUCUCAUACGUAAUUUCAUGUUGGCGC CCGAUCCGUGUAUAUCACCGAUAAUAACGACA <u>AAU</u> ACCCAUG
STM3375	<u>UUCAGGCUGGACCAGUGGACA</u> UCCACCGUCACAUCACCUGCCGGCAGUUGACUCUCUUCGAGAUGUUG CACGGAU GCGAGGGUUUACCGUCCUGCUGUUCUAAGAUCAACGCCUGCAUAACCUGUCCUCACUUUA CAUGGUAGAUUGGAAAAAUAGCUACGAAGACUAUACUCGCUA <u>AAU</u> AAAAACGUGAUGCCGAUGCAACG CAAUAAAUUGCCAGAUAGAUC <u>CAU</u> UUUGGUAGUAUGCCUGCUUCAUUGCGCGCCGUGGGCGAAUCCGC CUUCAGAUUCGCUUUUUCAUACUGUUUAUAACCGUC <u>GGAGU</u> UAACUCAAGGAUG
STM1703	<u>AUAGAU</u> AAAACA <u>AAU</u> ACGUUCAGCCAUA <u>AAU</u> ACCCUUAUUUAUAACAUGGCUAACCUUUCUUUCGGG CACCUGGCGCUAAA <u>U</u> GGGAUGGUACGCAUG
STM3611	<u>AGUCCGGACAGUCACACUCCCAUUAACAGGACA</u> ACUGAGAUG
STM1827	<u>UCGCGGUUGGCUUUUGUCGCCAACGCUUAUUGGGCGGCCCGCAUG</u>
STM1344	<u>AACCGUAGCAUUUACAAACGTACUUUUAUUA</u> AAAAACGGGCGUGUUCACGCCUGUGAAAAGUACAAGA UUGAAUAUUGGUUUUAUA <u>AUCAGAGU</u> AAGUUAAAAAAGGAACCGGUUCACCGGUAACAAGAAAAAU GAUGACGCUUCAAUUAGUAUCUGAAGUUACGUCUGUUUCCGUCCGUAGUGACUGGAUGGCGAAUAGC GCCUAACCAUGGGACUGGCGUAAUG
STM1697	<u>UUUUAUUGAUUGAUUUGCGUAAAAGCGCAUUAUCAGGGAGUUAAGAUCAAGUGGAGUGGUCACAU</u> <u>G</u>

GGA - element of putative CsrA binding boxes; **A**, **G** or **U** – transcriptional start site; **AUG** or **GUG** – initiation codon; underlined – predicted Shine-Dalgarno sequence

Table 4-3. Strains and plasmids used in this study.

Strain or plasmid	Description or genotype	Reference
Strains		
<i>Salmonella enterica</i> serovar Typhimurium ATCC 14028		
UMR1	ATCC 14028-1s Nal ^r	(Romling <i>et al.</i> , 1998)
MAE125	UMR1 <i>csrA::kan</i>	This study
MAE1491	UMR1 Δ <i>csrA</i>	This study
MAE130	UMR1 <i>STM3611-SPA kan^r</i>	(Simm <i>et al.</i> , 2009)
MAE1493	MAE1491 <i>STM3611-SPA kan^r</i>	This study
MAE132	UMR1 <i>STM1344-SPA kan^r</i>	(Simm <i>et al.</i> , 2009)
MAE1492	MAE1491 <i>STM1344-SPA kan^r</i>	This study
MAE1456	UMR1 <i>fliA::cat</i>	This study
MAE1463	UMR1 Δ <i>fliA</i> :101	This study
MAE1476	MAE125 <i>fliA::cat</i>	This study
MAE424	UMR1 <i>STM1344::cat</i>	(Simm <i>et al.</i> , 2007)
MAE1481	MAE1463 <i>STM1344::cat</i>	This study
MAE1474	MAE125 <i>STM1344::cat</i>	This study
Plasmids		
pKD46	Temperature-sensitive λ red recombinase expression vector	(Datsenko and Wanner, 2000)
pKD4	Template plasmid (<i>kan^r</i>) for mutant construction	(Datsenko and Wanner, 2000)
pKD3	Template plasmid (<i>cat^r</i>) for mutant construction	(Datsenko and Wanner, 2000)
pBAD28	Arabinose inducible expression plasmid	(Guzman <i>et al.</i> , 1995)
pBAD30	Arabinose inducible expression plasmid	(Guzman <i>et al.</i> , 1995)
pBAD <i>csrA</i>	<i>csrA</i> under control of the plasmid-borne P _{BAD} promoter	(Jonas <i>et al.</i> , 2008)
pIRF-2	<i>fliA</i> under control of the plasmid-borne P _{BAD} promoter	This study
pAS-0081	<i>flhDC</i> under control of the plasmid-borne P _{BAD} promoter	(Sittka <i>et al.</i> , 2008)

FIGURE LEGENDS

Figure 4-1. CsrA regulates the mRNA steady state level of genes encoding GGDEF/EAL domain proteins in *S. Typhimurium*. Relative mRNA levels of *STM1987*, *STM4551*, *STM3375*, *STM1703*, *STM3611*, *STM1827*, *STM1344* and *STM1697* were measured by quantitative Real-Time RT PCR in the wild type UMR1 (wt) and in the *csrA::kan* mutant MAE125 ($\Delta csrA$), carrying the empty vector pBAD28 (p28) or the CsrA vector pBADcsrA (pCsrA), respectively. Note that the data for *STM3611* are displayed with a logarithmic scale. Total RNA was isolated from bacterial cultures grown at 37 °C in LB medium with 0.1 % arabinose to OD₆₀₀ 1.5. The data values represent means with standard deviations (** $P < 0.01$; * $P < 0.05$).

Figure 4-2. Direct interaction between CsrA and the transcripts of *STM1987*, *STM3375*, *STM3611*, *STM1344* and *STM1697*. A) Gel mobility shift analyses of CsrA–*STM1987*, CsrA–*STM3375*, CsrA–*STM3611*, CsrA–*STM1344* and CsrA–*STM1697* interactions in the absence of RNA competitor. The 5' end-labelled respective transcript was incubated with CsrA at the indicated concentrations. The positions of free (F) and bound (B) RNA are shown. B) Competition reactions for *STM1344* and *STM3611* using specific (*STM1344*, *STM3611* or RNA10-2BS) or non-specific (*phoB*) unlabelled RNA competitors. The concentration of competitor RNA is shown at the bottom of each lane.

Figure 4-3. Indirect regulation of *STM3611* by CsrA through the flagella cascade. A) Protein levels of SPA-tagged *STM3611* in the wild type (wt) and the *csrA* deficient background ($\Delta csrA$). The bacteria were grown at 37 °C to OD₆₀₀ 1.5. B) A mutation in *csrA* results in a strong downregulation of flagella genes. mRNA levels were measured in the *csrA* mutant and the wild

type by quantitative Real-Time RT PCR after growing the bacteria at 37 °C to OD₆₀₀ 1.5. C) Complementation of the effect of a *csrA* mutation on *STM3611* and *STM1798* mRNA levels by plasmid-borne expression of *fliA* from pIRF-2 (pFliA). p30 corresponds to the empty vector control pBAD30. The values represent means with standard deviations (** $P < 0.01$; * $P < 0.05$). D) Complementation with the plasmid pAS-0081 (pFlhDC). The values represent means with standard deviations (** $P < 0.01$; * $P < 0.05$). E) Restoration of swimming motility in the *csrA* mutant. Swimming motility of the wild type strain carrying the empty vector pBAD28 (wt p28) or the *csrA* mutant MAE125 ($\Delta csrA$) carrying pBAD28, pBAD*csrA* (pCsrA), pAS-0081 (pFlhDC) or pIRF-2 (pFliA), respectively, was analysed in 0.3 % LB agar with 0.1 % arabinose at 37 °C. Four μ l of overnight cultures, which were grown in LB with 0.1 % arabinose, were used for the experiment. The swimming diameter vs. time is displayed.

Figure 4-4. Regulation of *STM3611* by CsrA. A) Effect of a *csrA* mutation on *STM3611* and *STM1798* mRNA levels in a *fliA* deficient background. RNA was isolated from bacterial cultures grown at 37 °C in LB medium with 0.1 % arabinose to OD₆₀₀ 1.5. mRNA levels of *STM3611* and *STM1798* were measured by quantitative Real-Time RT PCR in the *csrA* mutant MAE125 and the *fliA csrA* double mutant MAE1476 (*fliA csrA*). The values represent means with standard deviations (** $P < 0.01$). B) Schematic model depicting the inferred direct and indirect regulation of *STM3611* by CsrA.

Figure 4-5. CsrA-mediated regulation of *STM1344* and its downstream effects. A) Protein levels of SPA-tagged *STM1344* in the wild type (wt) and the *csrA* deficient background ($\Delta csrA$). The bacteria were grown at 37 °C to OD₆₀₀ 1.5. B) Effect of a mutation in *STM1344* ($\Delta 1344$) on the

mRNA levels of *STM3611*, *STM1798* and *fliA* measured by quantitative Real-Time RT PCR, after growth of the bacteria at 37 °C to OD₆₀₀ 1.5. The values represent means with standard deviations (** $P < 0.01$; * $P < 0.05$). C) Effect of a double mutation in *csrA* and *STM1344* ($\Delta csrA \Delta 1344$) on the mRNA levels of *STM3611*, *STM1798* and *fliA*. The values represent means with standard deviations (* $P < 0.05$). D) *STM1344* regulates rdar morphotype expression and CsgD levels through *fliA*. Rdar morphotype expression and CsgD protein levels were analysed in the wild type UMR1 and its isogenic mutants in *fliA*, *STM1344* and *fliA STM1344*. The bacteria were grown for 20 h or 24 h, respectively, at 28 °C on Congo Red (CR) LB agar plates without salt. E) Schematic model depicting the regulation of *STM3611* by *STM1344* through *fliA*. The model illustrates that CsrA controls the flagella cascade at multiple levels, through FlhDC, *STM1344* and *STM3611*.

Figure 4-6. Schematic model illustrating the interplay between the Csr-, the c-di-GMP and the flagella regulatory system in *Salmonella* Typhimurium. Apparent direct (solid line) and indirect (dashed line) roles of CsrA in the expression of genes encoding GGDEF and EAL domain proteins resulting in the tight control of the sessility-motility switch in *S. Typhimurium*. *STM4551* and *STM1987* possess DGC activity (Solano *et al.*, 2009, Garcia *et al.*, 2004), whereas *STM1703*, *STM1827* and *STM3611* act as PDEs (Simm *et al.*, 2007, Simm *et al.*, 2004). The c-di-GMP metabolizing activities of these proteins control phenotypes in motility, biofilm formation or virulence. In contrast, *STM1344*, *STM3375* and possibly *STM1697* contain degenerate EAL/GGDEF domains (unshaded), which cannot synthesize or degrade c-di-GMP, but have apparently evolved alternative functions, e.g. regulatory functions (Simm *et al.*, 2009). Notably, CsrA controls the flagella cascade at multiple levels in the hierarchy: by apparent direct

regulation of the flagella master regulator FlhDC and STM1344, which influences the flagella cascade upstream of *fliA*, and by apparent direct and indirect regulation of STM3611.

Presumably, this multi-layer control allows CsrA to coordinate flagella synthesis with motor function. By regulating STM3375 (CsrD), which, along with RNase E, destabilizes the CsrB and CsrC sRNAs in *E. coli* (Suzuki *et al.*, 2006), CsrA seems to control its own activity by an autoregulatory loop. CsrB and CsrC are positively controlled by the two-component system (TCS) BarA-SirA (Altier *et al.*, 2000b, Teplitski *et al.*, 2003), which allows the integration of environmental signals into the regulatory network. In *E. coli* (Gudapaty *et al.*, 2001) and in *S. Typhimurium* (our unpublished observations) transcription of *csrB* and *csrC* also requires upstream activation by CsrA, probably through the BarA-UvrY (BarA-SirA) TCS (Suzuki *et al.*, 2002), indicative of an additional feedback loop.

Fig. 4-1.

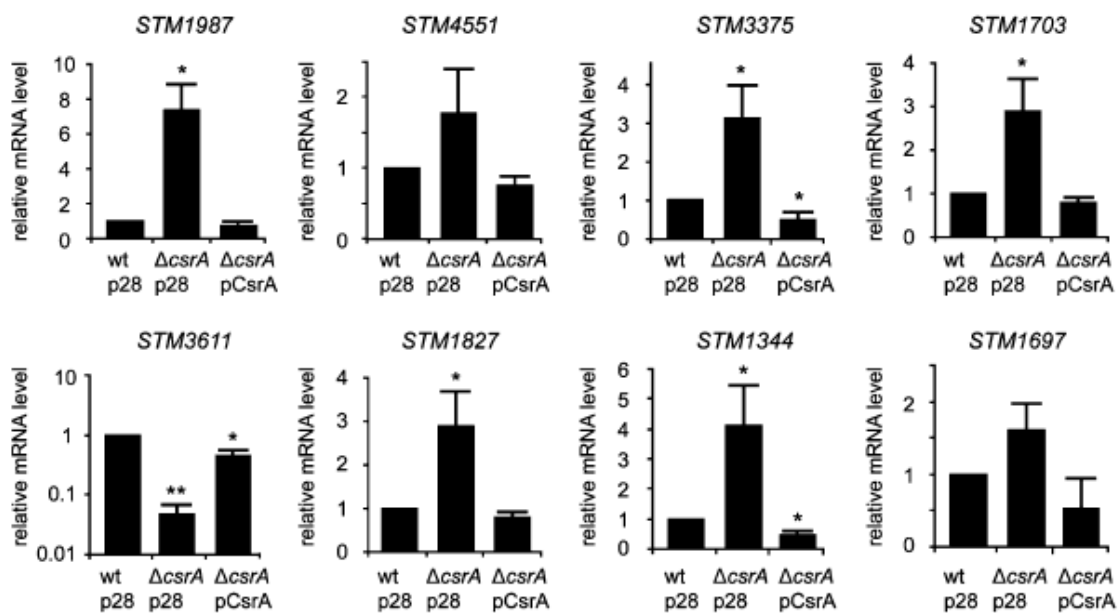


Fig. 4-2.

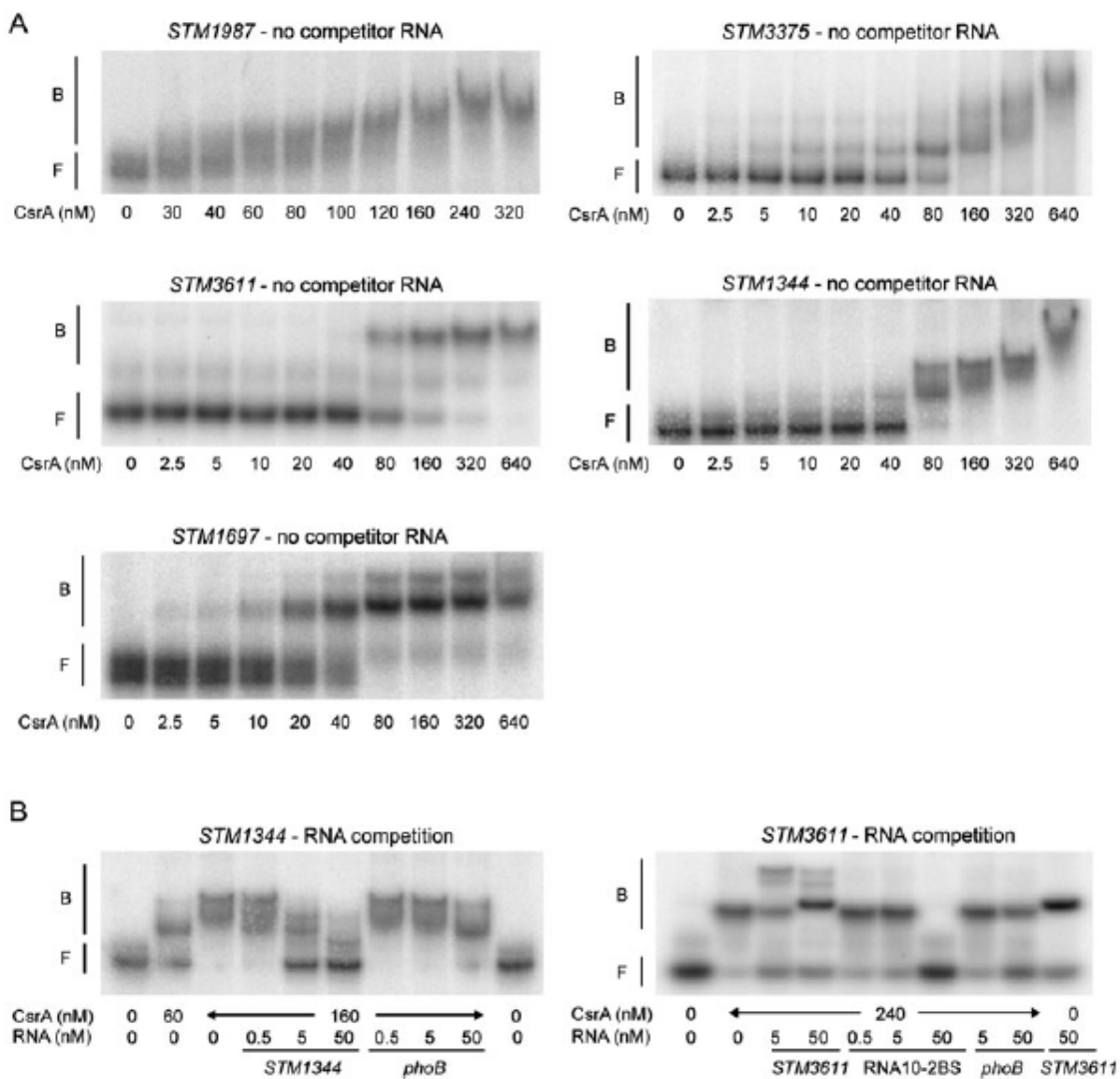


Fig. 4-3.

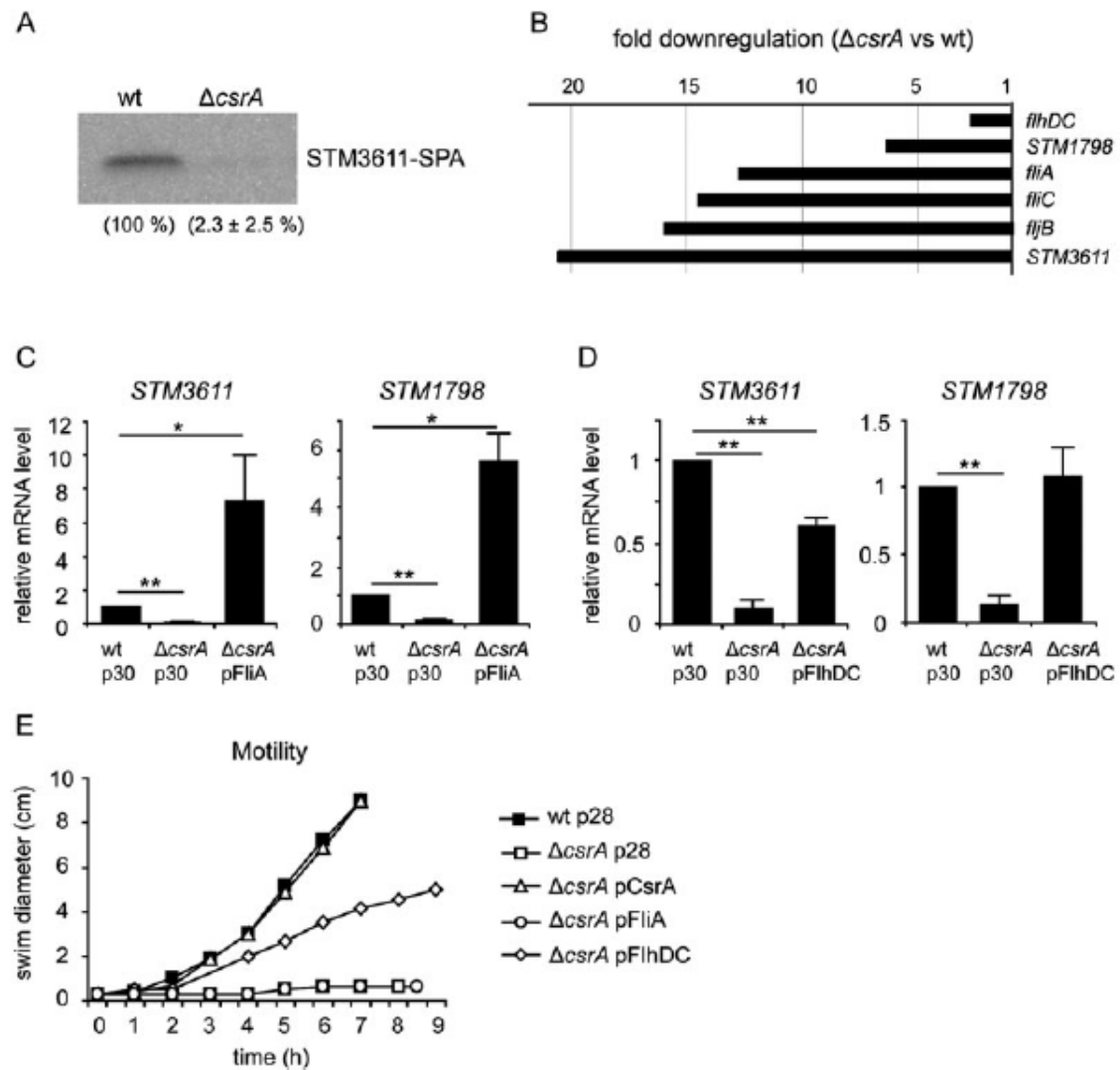


Fig. 4-4.

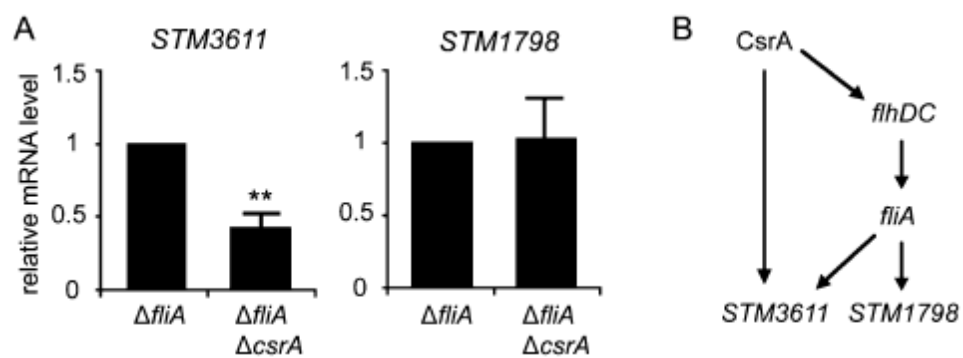


Fig. 4-5.

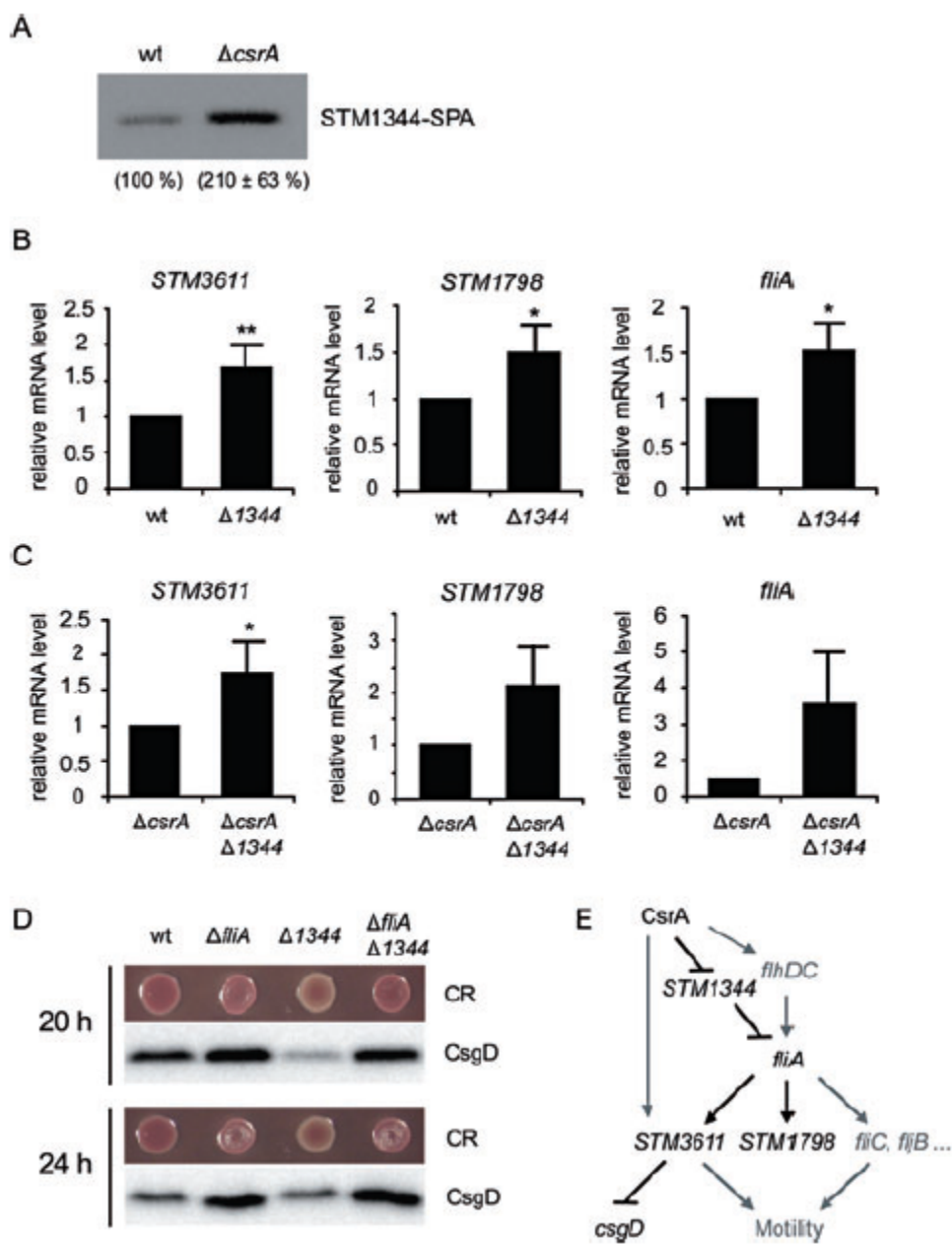
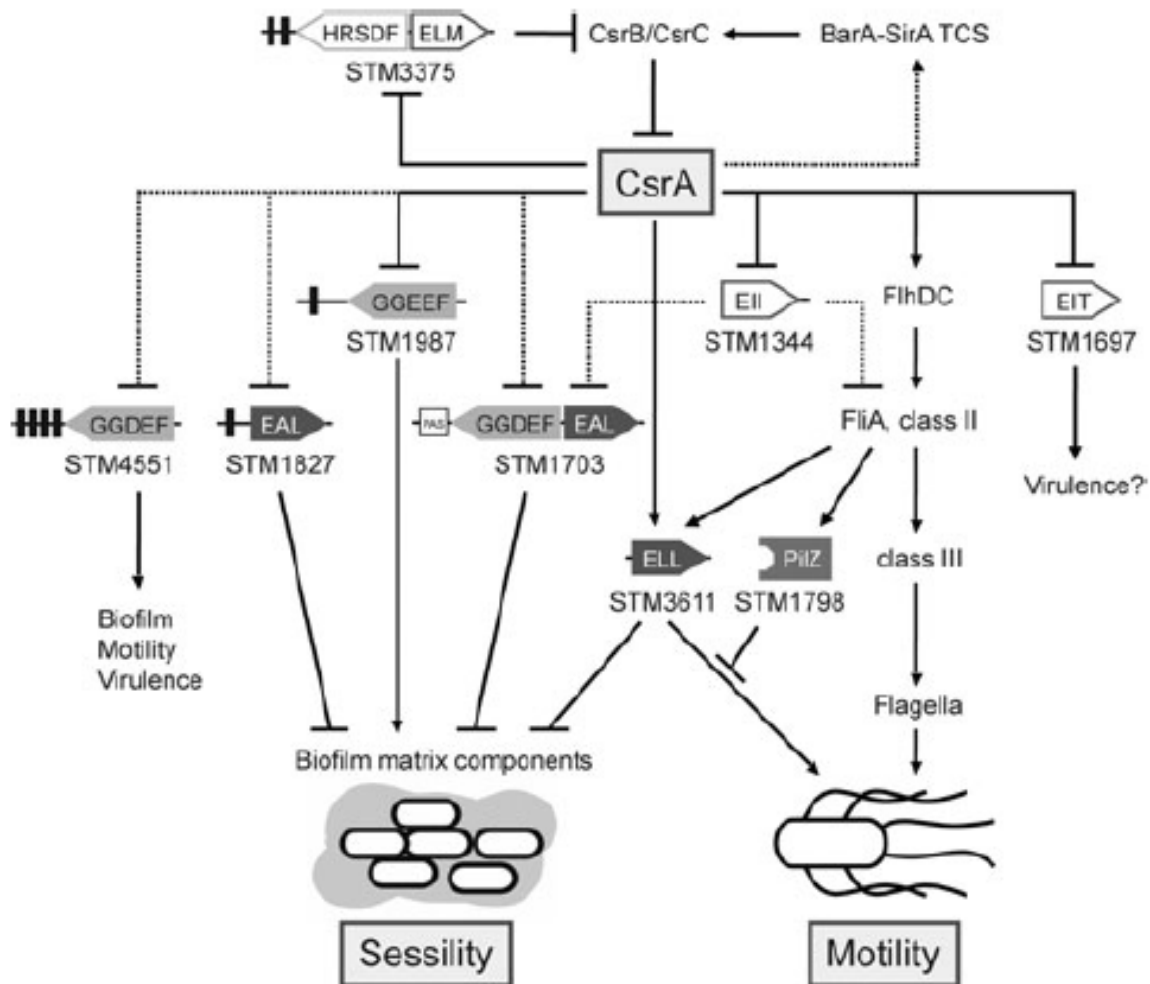


Fig. 4-6.



Chapter 5. Discussion

Global role of CsrA in *Escherichia coli*

CsrA has been implicated as a global regulator in a variety of prokaryotes, coordinating gene expression for many physiological processes (Romeo *et al.*, 1993; Romeo, 1998; Lawhon *et al.*, 2003; Timmermans and Van Melderen, 2010). Corroborating this hypothesis, the work presented here determined that CsrA in *Escherichia coli* K-12 has a potential regulon of 721 targets and regulates components of the stringent response and the metabolism of c-di-GMP. Although the CsrA-His₆ copurification screen was not saturated, the number of genes whose transcripts copurified with CsrA was comparable to a recent study that estimates that the regulon of CsrA (RsmA) of *Pseudomonas aeruginosa* PAK encompasses over 500 genes (Brencic and Lory, 2009).

Evidence that CsrA directly interacts with the majority of these transcripts *in vivo* is as follows: i) Few representatives of highly abundant classes of cellular RNAs, e.g. antisense sRNAs and tRNAs, were identified in these experiments, with the exception of rRNA (discussed below). ii) Low abundance transcripts, which have been previously found to be targets of CsrA binding, were identified (e.g. *flhDC* (Wei *et al.*, 2001)). iii) Less than 1% of the amount of RNA that was recovered by nickel affinity purification from cells expressing recombinant CsrA-His₆ protein was isolated from control cells lacking this protein. iv) Gel shift assays using the leaders of 25 of these transcripts revealed that CsrA bound to 80% with high affinity and specificity (unpublished data, A. N. Edwards and T. Romeo). Because CsrA can also interact with intervening noncoding

segments of polycistronic mRNAs (Yang *et al.*, 2010), we estimate that the maximal occurrence of false positives in the copurification experiments was 20%. We also recovered abundant rRNAs in our copurification experiments. These may have originated from polysomes of mRNAs that were bound specifically to CsrA, as CsrA was not identified in a blind screen for proteins that interact directly with ribosomes (Jiang *et al.*, 2007) nor was CsrA found to interact with ribosomal proteins in a comprehensive protein-protein interaction study (Butland *et al.*, 2005).

Two dimensional protein gel analysis revealed some novel potential targets of CsrA regulation (Appendix, Table 2). While some of these effects could be indirect, several transcripts that copurified with CsrA-His₆ were also identified in this analysis (Appendix, Table 3), strongly suggesting that these are direct targets of CsrA. Indeed, CsrA was already known to regulate phosphoenolpyruvate carboxykinase (encoded by *pckA*) and phosphoglucomutase (encoded by *pgm*) (Appendix, Table 3; Romeo *et al.*, 1993; Sabnis *et al.*, 1995). Additionally, *gatZ* was discovered through both analyses. Gel shift analyses confirmed a specific, high affinity interaction between CsrA and the 5' mRNA leader of *gatY* (unpublished data, A. N. Edwards and T. Romeo), the first gene in the *gatYZABCDR'* operon, which encodes the enzymes required for galactitol metabolism (Nobelmann and Lengeler, 1996). The *csrA* mutant also grew better than the wild-type strain on minimal media with galactitol as the only carbon source (unpublished data, A. N. Edwards and T. Romeo), suggesting that CsrA may directly repress expression of the *gatYZABCDR'* operon and that the upregulation of the *gat* operon in the *csrA* mutant may allow for more efficient utilization of this carbon source. Together, both of these global analyses indicated that a large number of metabolic and physiological processes are

included in the Csr regulon and confirms the critical role CsrA has in regulating carbon flux. Additionally, because the stringent response regulatory system is only one of many transcriptional regulatory systems whose mRNAs copurified with CsrA-His₆ (Appendix, Table 1), these data suggest that the extent of the complete regulon and circuitry of the Csr system is considerable and underappreciated.

Our data have not only revealed a more definitive role for CsrA as a global regulator, but have also indicated that CsrA may exert its effects on multiple levels to efficiently regulate a single cellular process. CsrA directly and post-transcriptionally represses *pgaABCD* expression (Wang *et al.*, 2005), which encodes the structural genes necessary for the synthesis of the polysaccharide adhesion, poly- β -1,6-*N*-acetylglucosamine, and is essential for biofilm formation in *E. coli* (Wang *et al.*, 2004). In addition, c-di-GMP promotes biofilm formation through regulating the expression of the *pgaABCD* operon in an unknown mechanism (Boehm *et al.*, 2009; unpublished data, M. Kumar, C. C. Goller, A. Pannuri and T. Romeo). We discovered that CsrA directly binds to the mRNA leaders and strongly represses the expression of the GGDEF domain proteins, *ydeH* and *ycdT*, and modestly affects expression of five other GGDEF domain proteins in *E. coli* (Chapter 3). Together, with the finding that the cellular concentration of c-di-GMP is increased approximately 2-fold in a *csrA* mutant (Chapter 3), these findings highlight an important regulatory connection between the Csr system, c-di-GMP metabolism and biofilm formation.

Our global analysis revealed an additional connection between CsrA and the expression of the *pgaABCD* operon. The *nhaR* transcript, encoding the transcriptional activator NhaR, which is required for transcription of *pgaABCD* (Goller *et al.*, 2006),

copurified with CsrA-His₆. Gel shift assays confirmed that CsrA directly binds to the *nhaR* mRNA leader with high affinity and specificity, while reporter fusions demonstrated that CsrA post-transcriptionally represses *nhaR* expression ~5-fold (unpublished data, A. Pannuri, A. N. Edwards and T. Romeo). Altogether, these data present a complex circuitry in which multiple effects of CsrA regulation converge to control PGA production and biofilm formation in *E. coli*. CsrA regulates biofilm formation through both c-di-GMP-independent and dependent mechanisms, allowing a variety of specific adaptive signals to trigger biofilm formation. These multiple effects of CsrA also provide a redundancy of regulation that likely affords robust regulation.

Our results further demonstrate that CsrA is a key regulator for controlling the switch between motility and biofilm formation in *E. coli* and *S. Typhimurium*. In *E. coli*, CsrA directly activates expression of *flhDC* (Wei *et al.*, 2001), which encodes the master regulator for the flagellar cascade. In *S. Typhimurium*, CsrA appears to possess a conserved role in promoting motility as CsrA positively regulates expression of *flhDC* and *yhjH*, which encodes a phosphodiesterase (Chapter 4). It is likely that CsrA may regulate *yhjH* expression in *E. coli* as well, but this has not been experimentally determined.

Although CsrA inhibits biofilm formation in both *E. coli* and *S. Typhimurium*, the mechanisms differ. *S. Typhimurium* does not produce PGA; here, CsrA likely inhibits biofilm formation by downregulating production of curli and cellulose (Chapter 4). Moreover, the set of GGDEF/EAL domain proteins regulated by CsrA differs between *E. coli* and *S. Typhimurium*. For example, CsrA directly represses expression of the two GGDEF domain proteins, YcdT and YdeH, which are present in *E. coli* but do not have

homologs in *S. Typhimurium*. While the mechanisms of regulation vary, CsrA plays a conserved global role in controlling these physiological processes, and it is possible that similar regulation occurs in most bacteria possessing a CsrA homolog.

Global regulators besides CsrA have been demonstrated to influence biofilm formation and motility (e.g. RpoS and cAMP-CRP; Karatan and Watnick, 2009; Sahr *et al.*, 2009; Fong and Yildiz, 2008). Similarly to CsrA, many of these directly and indirectly regulate the expression of GGDEF and EAL domain proteins (Weber *et al.*, 2006; Fong and Yildiz, 2008; Waters *et al.*, 2008). In addition, ppGpp has been implicated in regulating both biofilm formation (Boehm *et al.*, 2009) and motility (Lemke *et al.*, 2009) in *E. coli*. This multilayered control and interconnected regulation by and within the Csr, stringent response and c-di-GMP global regulatory systems allow for the incorporation of a variety of environmental stimuli and is likely a common manner for controlling physiological processes in bacteria.

Potential role of CsrA in regulation of secondary messenger metabolism

We have defined the regulatory interactions CsrA has with transcripts that encode proteins required for the metabolism of guanosine tetraphosphate (ppGpp) (Chapter 2) and cyclic di-GMP (Chapters 3 and 4). Our data demonstrate that the Csr system regulates the expression of ppGpp synthetases in *E. coli* and suggest that CsrA may control the synthesis of ppGpp in certain conditions in which a strong induction of stringent response occurs. Additionally, the Csr circuitry regulates the expression and activity of GGDEF and EAL domain proteins in *E. coli* and *S. Typhimurium*. Altogether,

these studies suggest that CsrA may be an important mediator of global second messenger metabolism.

With the modest effects of Csr on the expression of *relA*, *spoT* and *dksA*, it is likely that the Csr system may function to fine tune gene expression, rather than serving as an on/off switch. It is possible that CsrA-mediated regulation of *relA* and *spoT* expression affects levels of ppGpp. There were no significant changes between the wild-type and *csrA* mutant strains in basal levels of ppGpp, the kinetics of ppGpp synthesis upon amino acid starvation or in accumulation of ppGpp after the induction of stringent response in one dimensional TLC analysis (Appendix, Fig. 2). The relatively poor growth of the *csrA* mutant on minimal media prevented us from monitoring ppGpp levels under starvation conditions, which are necessary for maximum ppGpp synthesis. It is possible that under rich growth conditions, the amount of RelA protein in the wild-type strain is sufficient to fully respond to amino acid starvation. However, there may be other conditions that generate a stronger stringent response in which ppGpp levels between the wild-type and *csrA* mutant strains differ. Careful studies are needed to clarify the role CsrA may have in regulating ppGpp accumulation and the stringent response.

As previously mentioned, CsrA represses global c-di-GMP levels in *E. coli* by directly regulating expression of GGDEF domain proteins (Chapter 3) and may play a similar role in *S. Typhimurium* (Chapter 4). Interestingly, our data also implicate CsrD, a degenerate GGDEF/EAL domain protein that is not involved in c-di-GMP metabolism, as possessing a role as a regulator within the c-di-GMP network. CsrD may affect the metabolism of c-di-GMP through mediating the decay of the sRNAs, CsrB and CsrC,

thus, regulating CsrA activity. Furthermore, CsrA represses expression of *csrD* in both *E. coli* and *S. Typhimurium*, producing an autoregulatory loop to provide precise regulation of CsrA activity and likely c-di-GMP accumulation.

Preliminary data suggest that CsrA may also affect the synthesis and regulation of an additional secondary messenger, cyclic AMP (cAMP). The transcripts for *crp* and *cyaA*, which encode the catabolite repressor protein and adenylate cyclase respectively, copurify with CsrA-His₆ (Appendix, Table 1). Gel shift analyses confirm that CsrA directly bound to the *crp* transcript with high affinity and specificity (unpublished data, A. N. Edwards and T. Romeo), suggesting that CsrA may regulate expression of *crp* in vivo. CsrA also interacted with the *cyaA* mRNA leader but exhibited modest affinity and specificity. In addition, preliminary studies examining steady state *crp* transcript and CRP protein levels suggest that CsrA represses *crp* expression (unpublished data, A. N. Edwards and T. Romeo). Further studies are needed to determine the effect CsrA may have on *crp* and *cya* expression, but it is plausible that CsrA may influence catabolite repression. Because CsrA has a central role in regulating carbon metabolism and flux, regulation of catabolite repression would create an additional layer of control over the response to carbon availability in the environment. Overall, our data indicate that the Csr system may be a global regulator of secondary messenger metabolism in *E. coli* and other closely related organisms.

Complex interconnections between global regulatory networks

Our studies reveal that the Csr and stringent response networks possess direct and indirect regulatory interactions within and among the components of these systems.

While the influence of CsrA on the stringent response appears modest, ppGpp and DksA exhibited strong effects on the Csr components. This suggests that under nutrient starvation, it may be necessary to reduce CsrA activity by strong upregulation of the small regulatory RNAs, CsrB and CsrC. Indeed, *csrB* and *csrC* expression is significantly increased in minimal media, and a rapid reduction in CsrB levels is observed upon the addition of tryptone, casamino acids, or amino acids (Jonas and Melefors, 2009). DksA- and ppGpp -mediated reduction of CsrA activity may allow the upregulation of CsrA-repressed genes that are necessary for survival during nutrient starvation. Indeed, CsrA represses expression of a carbon starvation response gene, *cstA* (Dubey *et al.*, 2003), which is necessary for efficient peptide uptake (Schultz and Matin, 1991). Derepression of *cstA* expression during nutrient limitation may be needed for nutrient scavenging.

It is possible that the interconnection between these regulatory systems allows for efficient regulation of shared regulatory targets. CsrA directly and post-transcriptionally represses expression of *glgCAP* (Baker *et al.*, 2002), which encodes the structural genes for glycogen biosynthesis, while ppGpp directly activates *glgCAP* transcription (Romeo, 1989; Romeo *et al.*, 1990). Upon the induction of stringent response, ppGpp increases *glgCAP* transcription, while the reduction in CsrA activity through the DksA and ppGpp-mediated upregulation of *csrB* and *csrC* transcription allows for stabilization of the *glgCAP* transcript and, thus, efficient translation. Upregulating glycogen production is common during conditions in which an excess carbon source is available and other nutrients are limiting (Preiss and Romeo, 1994). In addition, CsrA activates motility by stabilizing the *flhDC* transcript (Wei *et al.*, 2001) while ppGpp and DksA directly repress

expression of *flhDC* (Lemke *et al.*, 2009). During the stringent response, downregulation of motility is mediated directly through ppGpp and DksA repression of *flhDC* transcription and the reduction of CsrA activity. This prevents further transcription of *flhDC* while also destabilizing the *flhDC* transcript, eliminating translation by facilitating mRNA turnover. Reducing the production of flagella during nutrient limitation allows the cell to conserve energy and nutrients. These data imply that under nutrient limiting conditions, DksA and ppGpp may indirectly upregulate *csrB* and *csrC* expression, reduce CsrA activity, and alter the expression of co-regulated genes in response to nutrient limitation. Additionally, this dual regulation provides control of gene expression at both the transcriptional and the post-transcriptional levels.

Our data indicate that DksA affects *csrA* expression primarily through the RpoS-dependent promoter, P3 (Chapter 2). It is possible that ppGpp is also needed for this regulation through RpoS as β -galactosidase activity from a P3 transcriptional fusion was decreased in a ppGpp⁰ strain. However, additional studies are needed to confirm whether ppGpp directly activates *csrA* expression through the P1 promoter independently of DksA. Additionally, characterizing the response of *csrA*, *csrB* and *csrC* expression and target genes that are co-regulated by stringent response and the Csr systems upon artificial induction of the stringent response by serine hydroxamate will provide further information for the importance of the signaling between these global networks.

Interestingly, both DksA and CsrA are necessary for full expression of *csrB* and *csrC* through the response regulator, UvrY. Although acetate is a physiological stimulus for BarA activity, we found that acetate accumulation is not altered in *dksA*, *csrA*, or *dksA csrA* mutants (Appendix, Fig. 4). It is possible that both DksA and CsrA may affect *barA*

expression and/or activity. However, preliminary data indicate that DksA activates *barA* expression 2-fold in exponential phase but both DksA and CsrA repress *barA* expression 11-fold and 4-fold, respectively, in stationary phase (unpublished data, A. N. Edwards and T. Romeo). Due to a reduction of competition for access to the secondary channel of RNA polymerase, the anti-termination factors GreA and GreB can upregulate transcription in a *dksA* mutant (Aberg *et al.*, 2008). Further studies are required to confirm that derepression of *barA* expression in a *dksA* mutant also occurs in the absence of GreA and/or GreB.

Altogether, our data suggest that both DksA and CsrA signal through regulating UvrY activity, although additional studies are needed to determine if BarA activity is necessary or if an unidentified factor regulates UvrY activity. Activity of GacA, the UvrY ortholog in *Pseudomonas* species, is regulated by the BarA homolog GacS, as well as two other sensors, RetS (Goodman *et al.*, 2004; Goodman *et al.*, 2009) and LadS (Ventre *et al.*, 2006), suggesting that alternative pathways for UvrY activation may also exist in *E. coli*.

Regulatory feedback loops provide distinct advantages for complex regulatory networks. Negative feedback loops reduce stochasticity and noise (Becskei and Serrano, 2000) while also decreasing bistability (Nevozhay *et al.*, 2009). Additionally, negative autoregulation, a regulatory element controlling both *dksA* (Chapter 2) and *csrA* (unpublished data, H. Yahknin and P. Babitzke) expression, accelerates regulatory responses since an intermediate level of the regulator represses its own expression (Rosenfeld *et al.*, 2002). Because multiple feedback loops are integrated within the Csr and stringent response regulatory networks, these advantages and characteristics may be

applied to these systems. Additionally, since both systems share some genetic targets, this creates a regulatory circuit known as a dense overlapping regulon (DOR), which allows the integration of multiple signals (Beisel and Storz, 2010). The regulatory impact of each of these feedback loops within both systems is not fully defined, and further studies are necessary to determine how environmental signals are efficiently translated into a singular response for downstream regulatory targets of only one or both systems.

Outlook

Our studies provide a foundation for understanding the impact that CsrA may have on global gene expression and have implicated CsrA as an important regulator of many cellular processes that were previously unknown. Because only two global regulatory systems of many were studied here, it is likely that the Csr circuitry functions within a broad genetic network. Indeed, *csrA* transcription is driven by three defined promoters, one of which is an RpoS-dependent promoter (unpublished data, H. Yahknin and P. Babitzke), and CsrA post-transcriptionally represses *hfq* expression (Baker *et al.*, 2007). These studies highlight the global interconnections between the Csr and other regulatory systems. Furthermore, our studies define a complex regulatory network in prokaryotes to include metabolic signaling and transcriptional and post-transcriptional regulatory interactions along with protein-RNA interactions. The combination of conventional molecular genetic studies and systems biology will provide a deeper understanding of the importance of biological networks and the control these have on the behavior of the cell. This understanding of natural networks may present guidelines for building synthetic networks for specific biotechnology functions or applications.

References

- Aberg, A., V. Shingler and C. Balsalobre. (2008) Regulation of the *fimB* promoter: a case of differential regulation by ppGpp and DksA in vivo. *Mol Microbiol* **67**: 1223-1241.
- Baker, C. S., L. A. Eory, H. Yakhnin, J. Mercante, T. Romeo and P. Babitzke. (2007) CsrA inhibits translation initiation of *Escherichia coli* *hfq* by binding to a single site overlapping the Shine-Dalgarno sequence. *J Bacteriol* **189**: 5472-5481.
- Baker, C. S., I. Morozov, K. Suzuki, T. Romeo and P. Babitzke. (2002) CsrA regulates glycogen biosynthesis by preventing translation of *glgC* in *Escherichia coli*. *Mol Microbiol* **44**: 1599-1610.
- Becskei, A. and L. Serrano. (2000) Engineering stability in gene networks by autoregulation. *Nature* **405**: 590-593.
- Beisel, C. L. and G. Storz. (2010) Base pairing small RNAs and their roles in global regulatory networks. *FEMS Microbiol Rev.*
- Boehm, A., S. Steiner, F. Zaehring, A. Casanova, F. Hamburger, D. Ritz, W. Keck, M. Ackermann, T. Schirmer and U. Jenal. (2009) Second messenger signalling governs *Escherichia coli* biofilm induction upon ribosomal stress. *Mol Microbiol* **72**: 1500-1516.
- Brencic, A. and S. Lory. (2009) Determination of the regulon and identification of novel mRNA targets of *Pseudomonas aeruginosa* RsmA. *Mol Microbiol* **72**: 612-632.
- Butland, G., J. M. Peregrin-Alvarez, J. Li, W. Yang, X. Yang, V. Canadien, A. Starostine, D. Richards, B. Beattie, N. Krogan, M. Davey, J. Parkinson, J.

- Greenblatt and A. Emili. (2005) Interaction network containing conserved and essential protein complexes in *Escherichia coli*. *Nature* **433**: 531-537.
- Dubey, A. K., C. S. Baker, K. Suzuki, A. D. Jones, P. Pandit, T. Romeo and P. Babitzke. (2003) CsrA regulates translation of the *Escherichia coli* carbon starvation gene, *cstA*, by blocking ribosome access to the *cstA* transcript. *J Bacteriol* **185**: 4450-4460.
- Fong, J. C. and F. H. Yildiz. (2008) Interplay between cyclic AMP-cyclic AMP receptor protein and cyclic di-GMP signaling in *Vibrio cholerae* biofilm formation. *J Bacteriol* **190**: 6646-6659.
- Goller, C., X. Wang, Y. Itoh and T. Romeo. (2006) The cation-responsive protein NhaR of *Escherichia coli* activates *pgaABCD* transcription, required for production of the biofilm adhesin poly-beta-1,6-N-acetyl-D-glucosamine. *J Bacteriol* **188**: 8022-8032.
- Goodman, A. L., B. Kulasekara, A. Rietsch, D. Boyd, R. S. Smith and S. Lory. (2004) A signaling network reciprocally regulates genes associated with acute infection and chronic persistence in *Pseudomonas aeruginosa*. *Dev Cell* **7**: 745-754.
- Goodman, A. L., M. Merighi, M. Hyodo, I. Ventre, A. Filloux and S. Lory. (2009) Direct interaction between sensor kinase proteins mediates acute and chronic disease phenotypes in a bacterial pathogen. *Genes Dev* **23**: 249-259.
- Jiang, M., S. M. Sullivan, A. K. Walker, J. R. Strahler, P. C. Andrews and J. R. Maddock. (2007) Identification of novel *Escherichia coli* ribosome-associated proteins using isobaric tags and multidimensional protein identification techniques. *J Bacteriol* **189**: 3434-3444.

- Jonas, K. and O. Melefors. (2009) The *Escherichia coli* CsrB and CsrC small RNAs are strongly induced during growth in nutrient-poor medium. *FEMS Microbiol Lett* **297**: 80-86.
- Karatan, E. and P. Watnick. (2009) Signals, regulatory networks, and materials that build and break bacterial biofilms. *Microbiol Mol Biol Rev* **73**: 310-347.
- Lawhon, S. D., J. G. Frye, M. Suyemoto, S. Porwollik, M. McClelland and C. Altier. (2003) Global regulation by CsrA in *Salmonella typhimurium*. *Mol Microbiol* **48**: 1633-1645.
- Lemke, J. J., T. Durfee and R. L. Gourse. (2009) DksA and ppGpp directly regulate transcription of the *Escherichia coli* flagellar cascade. *Mol Microbiol* **74**: 1368-1379.
- Nevozhay, D., R. M. Adams, K. F. Murphy, K. Josic and G. Balazsi. (2009) Negative autoregulation linearizes the dose-response and suppresses the heterogeneity of gene expression. *Proc Natl Acad Sci U S A* **106**: 5123-5128.
- Nobelmann, B. and J. W. Lengeler. (1996) Molecular analysis of the *gat* genes from *Escherichia coli* and of their roles in galactitol transport and metabolism. *J Bacteriol* **178**: 6790-6795.
- Preiss, J. and T. Romeo. (1994) Molecular biology and regulatory aspects of glycogen biosynthesis in bacteria. *Prog Nucleic Acid Res Mol Biol* **47**: 299-329.
- Romeo, T. (1998) Global regulation by the small RNA-binding protein CsrA and the non-coding RNA molecule CsrB. *Mol Microbiol* **29**: 1321-1330.

- Romeo, T., and J. Preiss. (1989) Genetic regulation of glycogen biosynthesis in *Escherichia coli*: in vitro effects of cyclic AMP and guanosine 5'-diphosphate 3'-diphosphate and analysis of in vivo transcripts. *J. Bacteriol.* **171**: 2773-2782.
- Romeo, T., M. Gong, M. Y. Liu and A. M. Brun-Zinkernagel. (1993) Identification and molecular characterization of *csrA*, a pleiotropic gene from *Escherichia coli* that affects glycogen biosynthesis, gluconeogenesis, cell size, and surface properties. *J Bacteriol* **175**: 4744-4755.
- Romeo, T., J. Black, and J. Preiss. (1990) Genetic regulation of glycogen synthesis in *Escherichia coli*: in vivo effects of the catabolite repression and stringent response systems in *glg* gene expression. *Curr. Microbiol.* **21**: 131-137.
- Rosenfeld, N., M. B. Elowitz and U. Alon. (2002) Negative autoregulation speeds the response times of transcription networks. *J Mol Biol* **323**: 785-793.
- Sabnis, N. A., H. Yang and T. Romeo. (1995) Pleiotropic regulation of central carbohydrate metabolism in *Escherichia coli* via the gene *csrA*. *J Biol Chem* **270**: 29096-29104.
- Sahr, T., H. Bruggemann, M. Jules, M. Lomma, C. Albert-Weissenberger, C. Cazalet and C. Buchrieser. (2009) Two small ncRNAs jointly govern virulence and transmission in *Legionella pneumophila*. *Mol Microbiol.*
- Schultz, J. E. and A. Matin, (1991) Molecular and functional characterization of a carbon starvation gene of *Escherichia coli*. *J Mol Biol* **218**: 129-140.
- Timmermans, J. and L. Van Melderen. (2010) Post-transcriptional global regulation by CsrA in bacteria. *Cell Mol Life Sci* **67**: 2897-2908.

- Ventre, I., A. L. Goodman, I. Vallet-Gely, P. Vasseur, C. Soscia, S. Molin, S. Bleves, A. Lazdunski, S. Lory and A. Filloux. (2006) Multiple sensors control reciprocal expression of *Pseudomonas aeruginosa* regulatory RNA and virulence genes. *Proc Natl Acad Sci U S A* **103**: 171-176.
- Wang, X., A. K. Dubey, K. Suzuki, C. S. Baker, P. Babitzke and T. Romeo. (2005) CsrA post-transcriptionally represses *pgaABCD*, responsible for synthesis of a biofilm polysaccharide adhesin of *Escherichia coli*. *Mol Microbiol* **56**: 1648-1663.
- Wang, X., J. F. Preston, 3rd and T. Romeo. (2004) The *pgaABCD* locus of *Escherichia coli* promotes the synthesis of a polysaccharide adhesin required for biofilm formation. *J Bacteriol* **186**: 2724-2734.
- Waters, C. M., W. Lu, J. D. Rabinowitz and B. L. Bassler. (2008) Quorum sensing controls biofilm formation in *Vibrio cholerae* through modulation of cyclic di-GMP levels and repression of *vpsT*. *J Bacteriol* **190**: 2527-2536.
- Weber, H., C. Pesavento, A. Possling, G. Tischendorf and R. Hengge. (2006) Cyclic-di-GMP-mediated signalling within the sigma network of *Escherichia coli*. *Mol Microbiol* **62**: 1014-1034.
- Wei, B. L., A. M. Brun-Zinkernagel, J. W. Simecka, B. M. Pruss, P. Babitzke and T. Romeo. (2001) Positive regulation of motility and *flhDC* expression by the RNA-binding protein CsrA of *Escherichia coli*. *Mol Microbiol* **40**: 245-256.
- Yang, T. Y., Y. M. Sung, G. S. Lei, T. Romeo and K. F. Chak. (2010) Posttranscriptional repression of the *cel* gene of the ColE7 operon by the RNA-binding protein CsrA of *Escherichia coli*. *Nucleic Acids Res.*

Appendix. Supporting Information for Chapter 2

Adrienne N. Edwards¹, Laura Patterson-Fortin², Christopher A. Vakulskas², Jeffrey W. Mercante¹, Katarzyna Potrykus³, Martha I. Camacho⁴, Joshua A. Fields⁵, Stuart A. Thompson⁵, Dimitris Georgellis⁴, Michael Cashel³, Paul Babitzke⁶, and Tony Romeo^{1,2§}

¹Department of Microbiology and Immunology, Emory University School of Medicine, Atlanta, GA 30322, USA, ²Department of Microbiology and Cell Science, University of Florida, Gainesville, FL 32611, USA, ³Laboratory of Molecular Genetics, NICHD, NIH, Bethesda, MA 20892, USA, ⁴Departamento de Genética Molecular, Instituto de Fisiología Celular, Universidad Nacional Autónoma de México, Mexico City, Mexico, ⁵Department of Biochemistry and Molecular Biology, Medical College of Georgia, Augusta, GA 30912, USA, ⁶Department of Biochemistry and Molecular Biology, Pennsylvania State University, University Park, PA 16802, USA, §Corresponding Author: Fax: 1 (352) 392-5922. Phone: 1 (352) 392-2400. Email: tromeo@ufl.edu

This partial manuscript was submitted to *Molecular Microbiology* as supporting information for Chapter 2. Martha I. Camacho and Dimitris Georgellis performed the acetate accumulation studies. Joshua A. Fields and Stuart A. Thompson performed the two dimensional protein gels and annotation. Adrienne N. Edwards performed all other experiments and analysis.

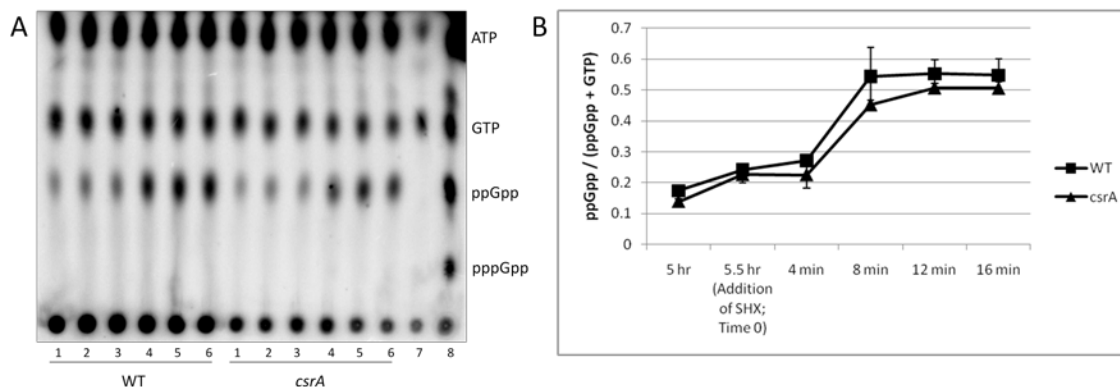


Figure 1

ppGpp quantification with one dimensional thin-layer chromatography (TLC). MG1655 (wild-type) and *csrA* strains were grown in EZ Rich Defined Medium (EZ RDM; Teknova, Hollister, CA) containing 0.33 mM K_2HPO_4 and 20 $\mu Ci\ ml^{-1}$ ^{32}P orthophosphate (Perkin-Elmer). After taking two time points in mid-exponential phase, 100 $\mu g\ ml^{-1}$ serine hydroxamate (SHX) was added and aliquots were sampled every four minutes up to 16 minutes. Nucleotide extraction was performed by adding 200 μl of culture to 40 μl of cold formic acid and incubating on ice for approximately 20 minutes. Following centrifugation, 16 μl of supernatant was spotted onto PEI-F cellulose TLC plates and separated in 1.5 M KH_2PO_4 (pH 3.4). (A) ppGpp analysis. Lanes 1, 5 hours; Lanes 2, 5.5 hours (addition of serine hydroxamate = Time 0); Lanes 3, 4 minutes; Lanes 4, 8 minutes; Lanes 5, 12 minutes; Lanes 6, 16 minutes; Lane 7, *relA spoT* (ppGpp⁰) in EZ RDM and 100 $\mu g\ ml^{-1}$ serine hydroxamate; Lane 8, MG1655 (wild-type) in MOPS minimal media and 100 $\mu g\ ml^{-1}$ serine hydroxamate. Cold ATP and GTP were also spotted and visualized by UV shadowing to confirm migration products. (B) Ratio of ppGpp to total guanine nucleotide (ppGpp and GTP) for both the wild-type (■) and *csrA* mutant (▲). Error bars represent standard deviation.

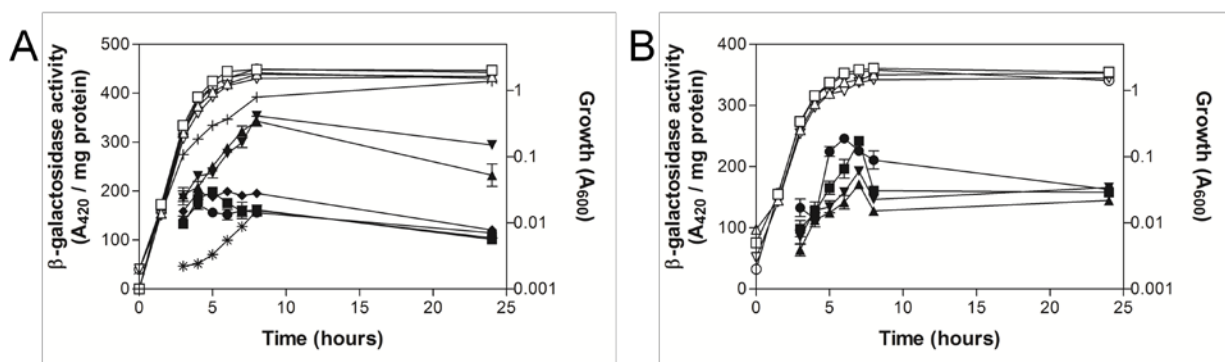


Figure 2

Complementation of *dksA* mutant on *dksA-lacZ* and *PlacUV5-dksA'*-*lacZ* expression.

Symbols for β -galactosidase activity corresponding to each strain are: CF7789 (wild-type), \blacksquare ; *dksA*, \blacktriangle ; *dksA* pHM1883 (empty vector), \blacktriangledown ; *dksA* pHM1506 (*dksA*⁺), \blacklozenge ; *dksA* pHM1506 + 0.1 mM IPTG, \bullet , and *dksA* pHM1506 + 1 mM IPTG, $*$. Growth curves are represented by open symbols except for *dksA* pHM1506 + 1 mM IPTG (+). The values represent the average of two independent experiments. Error bars depict the standard error of the mean. (A) β -galactosidase specific activity from a *dksA-lacZ* transcriptional fusion. (B) β -galactosidase specific activity from a *PlacUV5dksA'*-*lacZ* leader fusion.

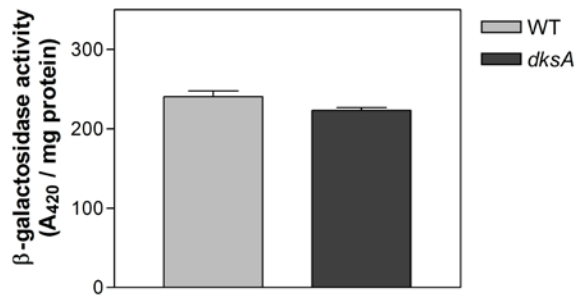


Figure 3

Effect of *dksA* on *uvrY* expression. β -galactosidase specific activity (A_{420} / mg protein) was measured at 8 hours of growth from a chromosomal *uvrY*'-*lacZ* translational fusion. The values represent the average of two independent experiments, and error bars depict the standard error of the mean.

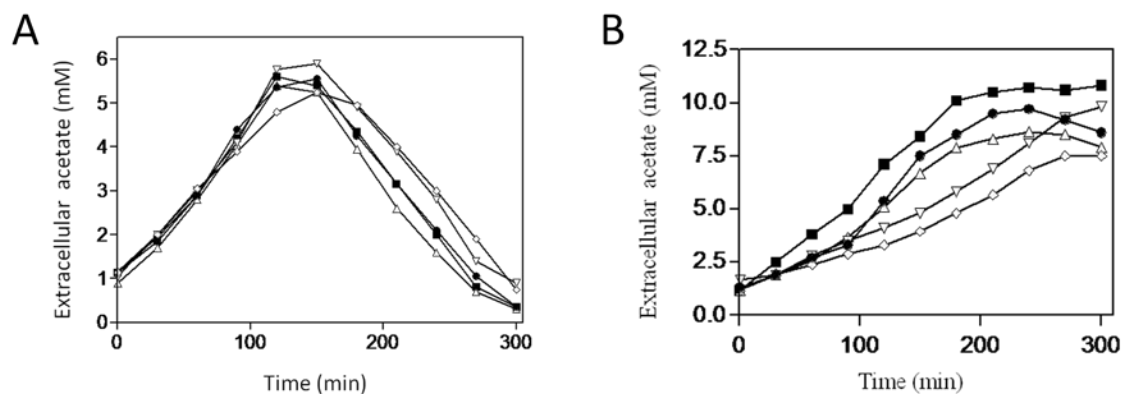


Figure 4

Acetate accumulation in wild-type (■), *csrA* (△), *dksA* (▽), *csrA dksA* (●), and *relA spoT* (◇) strains grown in (A) the gluconeogenic LB medium (pH 7.0) or (B) the glycolytic Kornberg medium with 0.5% glucose (pH 6.8). Samples were withdrawn at the indicated times, and the concentration of extracellular acetate was determined using the R-Biopharm Acetic acid determination kit (Boehringer Mannheim). The averages of three independent experiments are presented (standard deviations were less than 5% from the mean).

Table 1. Identities of RNAs that copurified with CsrA-His₆.

Gene Name ^a	Pull-down Condition ^b
J – Translation, ribosomal structure and biogenesis	
<i>yadB</i>	KB – Exponential phase
<i>leuS</i>	KB – Exponential phase
<i>glnS</i>	KB – Exponential phase
<i>serS</i>	KB – Exponential phase
<i>rpsA</i>	KB – Exponential phase
<i>yciO</i>	KB – Exponential phase
<i>pheT</i> (R)	KB – Exponential phase
<i>infC</i>	KB – Exponential phase
<i>thrS</i>	KB – Exponential phase; LB – Exponential phase
<i>aspS</i>	KB – Exponential phase
<i>yeiP</i>	KB – Exponential phase
<i>truA</i>	KB – Exponential phase
<i>raiA</i> (<i>yfiA</i>)	KB – Exponential phase; LB – Exponential phase
<i>alaS</i>	KB – Exponential phase
<i>lysS</i>	KB – Exponential phase
<i>pnp</i>	KB – Exponential phase
<i>prmA</i>	KB – Exponential phase
<i>rpsK</i>	KB – Exponential phase
<i>rpsM</i>	KB – Exponential phase
<i>rpsE</i>	KB – Exponential phase
<i>rplR</i>	KB – Exponential phase
<i>rplE</i>	KB – Exponential phase
<i>rplX</i>	KB – Exponential phase
<i>rpsC</i>	KB – Exponential phase
<i>hslR</i>	KB – Exponential phase
<i>glyS</i>	KB – Exponential phase
<i>rph</i>	KB – Exponential phase
<i>trmH</i> (<i>spoU</i>)	KB – Exponential phase
<i>lysU</i>	KB – Exponential phase; LB – Exponential phase
<i>rne</i>	LB – Exponential phase
<i>fmt</i>	KB – Exponential phase
<i>rplW</i>	KB – Exponential phase
<i>selB</i>	KB – Exponential phase
<i>smpA</i>	LB – Exponential phase
<i>truC</i>	LB – Exponential phase
<i>rimN</i>	LB – Exponential phase
<i>tufB</i>	LB – Exponential phase
K – Transcription	
<i>nhaR</i>	KB – Exponential phase
<i>hepA</i> (L)	KB – Exponential phase
<i>yafY</i>	KB – Exponential phase
<i>mhpR</i>	KB – Exponential phase
<i>ybdO</i>	KB – Exponential phase
<i>rutR</i> (<i>ydcC</i>)	KB – Exponential phase

<i>uidR</i>	KB – Exponential phase
<i>ydhM</i>	KB – Exponential phase
<i>rpoE</i>	KB – Exponential phase
<i>yfiE</i>	KB – Exponential phase
<i>ascG</i>	KB – Exponential phase
<i>rpoD</i>	KB – Exponential phase
<i>ebgR</i>	KB – Exponential phase
<i>yhaJ</i>	KB – Exponential phase
<i>sohA (prlF)</i>	KB – Exponential phase
<i>agaR (G)</i>	KB – Exponential phase
<i>nanK (G)</i>	KB – Exponential phase
<i>fusA</i>	KB – Exponential phase
<i>rpsG</i>	KB – Exponential phase
<i>yhgF</i>	KB – Exponential phase
<i>malT</i>	KB – Exponential phase
<i>rpoH</i>	KB – Exponential phase
<i>nikR</i>	KB – Exponential phase
<i>dgoR</i>	KB – Exponential phase
<i>rho</i>	KB – Exponential phase
<i>metR</i>	KB – Exponential phase
<i>yihW (G)</i>	KB – Exponential phase
<i>cytR</i>	KB – Exponential phase; LB – Exponential phase
<i>fabR</i>	KB – Exponential phase
<i>nusG</i>	KB – Exponential phase
<i>rpoB</i>	KB – Exponential phase
<i>iclR</i>	KB – Exponential phase
<i>dcuR (T)</i>	KB – Exponential phase
<i>allR</i>	LB – Exponential phase
<i>dicA</i>	LB – Exponential phase
<i>hyfR (T)</i>	KB – Exponential phase
<i>nsrR</i>	KB – Exponential phase
<i>cdaR (T)</i>	LB – Exponential phase
<i>fhlA (T)</i>	LB – Exponential phase
<i>ycfQ</i>	LB – Stationary phase

L – DNA replication, recombination and repair

<i>yafM</i>	KB – Exponential phase
<i>recG (K)</i>	KB – Exponential phase
<i>yagA</i>	KB – Exponential phase
<i>sbcC</i>	KB – Exponential phase
<i>ybcK</i>	KB – Exponential phase
<i>nohB</i>	KB – Exponential phase
<i>hola</i>	KB – Exponential phase
<i>helD</i>	KB – Exponential phase ; LB – Exponential phase
<i>ycfH</i>	KB – Exponential phase
<i>topB</i>	KB – Exponential phase
<i>ligA</i>	KB – Exponential phase
<i>intA</i>	KB – Exponential phase
<i>recC</i>	KB – Exponential phase

<i>parE</i>	KB – Exponential phase
<i>smf</i> (U)	KB – Exponential phase
<i>yhhF</i>	KB – Exponential phase
<i>mutM</i>	KB – Exponential phase
<i>ligB</i>	KB – Exponential phase
<i>dnaN</i>	KB – Exponential phase
<i>dnaA</i>	KB – Exponential phase
<i>uvrD</i>	KB – Exponential phase
<i>dnaB</i>	KB – Exponential phase
<i>sbcD</i>	KB – Exponential phase
<i>insH-6</i>	KB – Exponential phase
<i>insH-7</i>	KB – Exponential phase
<i>insH-3</i>	LB – Exponential phase
<i>insB</i>	LB – Exponential phase
<i>insH-1</i>	KB – Stationary phase
D – Cell division and chromosome partitioning, cell cycle control	
<i>ftsA</i>	KB – Exponential phase
<i>mukB</i>	KB – Exponential phase; LB – Exponential phase
<i>mreB</i>	KB – Exponential phase
<i>gidA</i>	KB – Exponential phase
<i>ftsN</i>	KB – Exponential phase
<i>ftsZ</i>	KB – Exponential phase; LB – Exponential phase
<i>etk</i> (M)	LB – Exponential phase
O – Posttranslational modification, protein turnover, chaperones	
<i>dnaJ</i>	KB – Exponential phase
<i>dapB</i>	KB – Exponential phase
<i>glnD</i>	KB – Exponential phase
<i>tig</i>	KB – Exponential phase
<i>clpP</i> (U)	KB – Exponential phase
<i>clpX</i>	KB – Exponential phase
<i>ppiD</i>	KB – Exponential phase
<i>dsbG</i>	KB – Exponential phase
<i>yliJ</i>	KB – Exponential phase
<i>ydfT</i>	KB – Exponential phase
<i>htpX</i>	KB – Exponential phase
<i>yedF</i>	KB – Exponential phase
<i>hscA</i>	KB – Exponential phase
<i>hscB</i>	KB – Exponential phase
<i>hypB</i> (K)	KB – Exponential phase
<i>hypC</i>	KB – Exponential phase
<i>hypE</i>	KB – Exponential phase
<i>ygcF</i>	KB – Exponential phase
<i>hybG</i>	KB – Exponential phase
<i>ftsH</i> (<i>hflB</i>)	KB – Exponential phase
<i>yhfA</i>	KB – Exponential phase; LB – Exponential phase
<i>trxA</i> (C)	KB – Exponential phase
<i>hslU</i>	KB – Exponential phase
<i>nrfE</i>	KB – Exponential phase

<i>nrfF</i>	KB – Exponential phase
<i>trxB</i>	LB – Exponential phase
<i>gst</i>	LB – Exponential phase
<i>fkpB</i>	KB – Exponential phase; LB – Exponential phase
<i>cyoE</i>	KB – Exponential phase; LB – Exponential phase
<i>dsbC</i>	KB – Exponential phase
<i>yggG</i>	KB – Exponential phase
<i>lon</i>	LB – Exponential phase
<i>groL</i>	KB – Stationary phase
<i>smpB</i>	LB – Stationary phase
M – Cell wall, membrane and envelope biogenesis	
<i>caiT</i>	KB – Exponential phase
<i>imp</i>	KB – Exponential phase
<i>ddlB</i>	KB – Exponential phase
<i>ftsQ</i>	KB – Exponential phase; LB – Exponential phase
<i>yaeT</i>	KB – Exponential phase
<i>acrA</i>	KB – Exponential phase
<i>rhsD</i>	KB – Exponential phase; LB – Exponential phase
<i>ompT</i>	KB – Exponential phase
<i>cusC</i> (U)	KB – Exponential phase
<i>rlpA</i>	KB – Exponential phase
<i>pal</i>	KB – Exponential phase; LB – Exponential phase; LB – Stationary phase
<i>ompA</i>	KB – Exponential phase; LB – Exponential phase
<i>lolE</i>	KB – Exponential phase
<i>ycgV</i> (U)	KB – Exponential phase
<i>kdsA</i>	KB – Exponential phase
<i>msbB</i> (<i>lpxM</i>)	KB – Exponential phase
<i>cld</i>	KB – Exponential phase
<i>gif</i>	KB – Exponential phase
<i>yehZ</i>	KB – Exponential phase
<i>pbpG</i>	KB – Exponential phase
<i>ompC</i>	KB – Exponential phase; LB – Exponential phase
<i>yfdH</i>	KB – Exponential phase
<i>mreC</i>	KB – Exponential phase
<i>mrcA</i>	KB – Exponential phase
<i>yhiI</i>	KB – Exponential phase; LB – Stationary phase
<i>yhjG</i>	KB – Exponential phase
<i>hldD</i> (G)	KB – Exponential phase
<i>waaU</i> (<i>rfaK</i>)	KB – Exponential phase; LB – Exponential phase
<i>waaR</i> (<i>rfaJ</i>)	KB – Exponential phase
<i>waaO</i> (<i>rfaI</i>)	KB – Exponential phase
<i>glmU</i>	KB – Exponential phase
<i>rffG</i>	KB – Exponential phase; LB – Exponential phase
<i>skp</i>	LB – Exponential phase
<i>ompF</i>	LB – Exponential phase
<i>csgG</i>	LB – Exponential phase
<i>ompX</i>	LB – Exponential phase
<i>ydeU</i> (U)	LB – Exponential phase

<i>murB</i>	LB – Exponential phase
<i>glmS</i>	LB – Stationary phase
N – Cell motility and secretion	
<i>ybgD</i> (U)	KB – Exponential phase
<i>flgE</i>	KB – Exponential phase
<i>fliK</i>	KB – Exponential phase
<i>yqiG</i> (U)	KB – Exponential phase
<i>yraJ</i> (U)	KB – Exponential phase
<i>gspD</i> (U)	KB – Exponential phase
<i>gspF</i> (U)	KB – Exponential phase
<i>aer</i> (T)	LB – Exponential phase
P – Inorganic ion transport and metabolism	
<i>kefC</i>	KB – Exponential phase
<i>thiP</i>	KB – Exponential phase
<i>metN</i>	KB – Exponential phase
<i>cynX</i>	KB – Exponential phase
<i>tauA</i>	KB – Exponential phase
<i>ybeX</i>	KB – Exponential phase; LB – Exponential phase
<i>modA</i>	KB – Exponential phase
<i>cvrA</i>	KB – Exponential phase
<i>ydaN</i>	KB – Exponential phase
<i>cysW</i>	KB – Exponential phase
<i>yfeX</i>	KB – Exponential phase
<i>focB</i>	KB – Exponential phase
<i>cysI</i>	KB – Exponential phase
<i>ygjE</i>	KB – Exponential phase
<i>yheM</i>	KB – Exponential phase
<i>zntA</i>	KB – Exponential phase
<i>yieL</i>	KB – Exponential phase
<i>corA</i>	KB – Exponential phase
<i>katG</i>	KB – Exponential phase; LB – Exponential phase
<i>nrfA</i>	KB – Exponential phase
<i>copA</i>	KB – Exponential phase; LB – Exponential phase
<i>ydeN</i>	LB – Exponential phase
<i>fecB</i>	LB – Exponential phase
<i>yfbS</i>	KB – Exponential phase
<i>feoB</i>	KB – Exponential phase
<i>yjbB</i>	KB – Exponential phase
<i>fecR</i> (T)	KB – Exponential phase
<i>citT</i>	LB – Exponential phase
<i>sodB</i>	LB – Exponential phase
<i>dps</i>	KB – Stationary phase
<i>cysQ</i>	LB – Stationary phase
T – Signal transduction mechanisms	
<i>dksA</i>	KB – Exponential phase; LB – Exponential phase
<i>phoR</i>	KB – Exponential phase
<i>cusS</i>	KB – Exponential phase
<i>ybeZ</i>	KB – Exponential phase

<i>narL</i> (K)	KB – Exponential phase
<i>uspE</i>	KB – Exponential phase; LB – Exponential phase
<i>baeR</i> (K)	KB – Exponential phase
<i>yfhK</i>	KB – Exponential phase
<i>ptsP</i>	KB – Exponential phase
<i>ecfG</i> (<i>htrG</i>)	KB – Exponential phase
<i>crp</i>	KB – Exponential phase; LB – Exponential phase
<i>ompR</i> (K)	KB – Exponential phase
<i>uspA</i>	KB – Exponential phase
<i>typA</i> (<i>bipA</i>)	KB – Exponential phase
<i>uspD</i> (<i>yiiT</i>)	KB – Exponential phase
<i>dcuS</i>	KB – Exponential phase
<i>relA</i> (K)	KB – Exponential phase; LB – Exponential phase
<i>rseA</i>	LB – Exponential phase
<i>ylaB</i>	LB – Stationary phase
<i>basS</i>	LB – Stationary phase

C – Energy production and conversion

<i>leuB</i> (E)	KB – Exponential phase
<i>yagR</i>	KB – Exponential phase
<i>yajO</i>	KB – Exponential phase
<i>sdhD</i>	KB – Exponential phase
<i>sucB</i>	KB – Exponential phase
<i>galT</i>	KB – Exponential phase
<i>cydD</i> (O)	KB – Exponential phase
<i>dmsA</i>	KB – Exponential phase
<i>pflB</i>	KB – Exponential phase
<i>hyaA</i>	KB – Exponential phase
<i>icd</i>	KB – Exponential phase
<i>narG</i>	KB – Exponential phase; LB – Exponential phase
<i>narH</i>	KB – Exponential phase
<i>narJ</i>	KB – Exponential phase
<i>narI</i>	KB – Exponential phase; LB – Exponential phase
<i>ydbK</i>	KB – Exponential phase
<i>paaZ</i> (I)	KB – Exponential phase
<i>ydiJ</i>	KB – Exponential phase
<i>ydjA</i>	KB – Exponential phase
<i>torZ</i>	KB – Exponential phase
<i>dld</i>	KB – Exponential phase
<i>napH</i>	KB – Exponential phase
<i>napA</i>	KB – Exponential phase; LB – Exponential phase
<i>glpA</i>	KB – Exponential phase; LB – Exponential phase
<i>glpC</i>	KB – Exponential phase
<i>nuoH</i>	KB – Exponential phase; LB – Exponential phase
<i>nuoG</i>	KB – Exponential phase
<i>ackA</i>	KB – Exponential phase
<i>maeB</i>	KB – Exponential phase; LB – Exponential phase
<i>hyfE</i>	KB – Exponential phase
<i>gabD</i>	KB – Exponential phase

<i>hydN</i>	KB – Exponential phase
<i>hycG</i>	KB – Exponential phase
<i>hycE</i>	KB – Exponential phase
<i>ygcN</i>	KB – Exponential phase
<i>fldB</i>	KB – Exponential phase; LB – Exponential phase
<i>glcB</i>	KB – Exponential phase; LB – Stationary phase
<i>glcD</i>	KB – Exponential phase
<i>tdcE</i>	KB – Exponential phase; LB – Exponential phase
<i>tdcD</i>	KB – Exponential phase
<i>mdh</i>	KB – Exponential phase
<i>yhdH</i> (R)	KB – Exponential phase; LB – Exponential phase
<i>prkB</i>	KB – Exponential phase; LB – Exponential phase
<i>pckA</i>	KB – Exponential phase
<i>yidS</i> (cbrA)	KB – Exponential phase
<i>atpF</i>	KB – Exponential phase
<i>fdoI</i>	KB – Exponential phase
<i>fdoG</i>	KB – Exponential phase
<i>fpr</i>	KB – Exponential phase; LB – Exponential phase
<i>ppc</i>	KB – Exponential phase
<i>fumB</i>	KB – Exponential phase
<i>ykgE</i>	LB – Exponential phase
<i>frdB</i>	LB – Exponential phase
<i>aceE</i>	LB – Exponential phase
<i>cydB</i>	KB – Exponential phase
<i>adhE</i>	KB – Exponential phase
<i>cyoB</i>	LB – Exponential phase
<i>putA</i>	LB – Exponential phase; LB – Stationary phase
<i>fdnI</i>	LB – Exponential phase
<i>yeaU</i> (E)	LB – Exponential phase
<i>napG</i>	LB – Exponential phase
<i>napF</i>	LB – Exponential phase
<i>glpQ</i>	LB – Exponential phase
<i>nuoB</i>	LB – Exponential phase
<i>nirB</i>	LB – Exponential phase
<i>aldA</i>	LB – Stationary phase
<i>yfiQ</i>	LB – Stationary phase
<i>aceB</i>	LB – Stationary phase
<i>acnB</i>	LB – Stationary phase
G – Carbohydrate transport and metabolism	
<i>fruB</i>	KB – Exponential phase
<i>yadI</i>	KB – Exponential phase
<i>yagG</i>	KB – Exponential phase
<i>nagB</i>	KB – Exponential phase
<i>pgm</i>	KB – Exponential phase
<i>dhaM</i> (S)	KB – Exponential phase; LB – Exponential phase
<i>ycjT</i>	KB – Exponential phase
<i>yniA</i>	KB – Exponential phase
<i>chbC</i>	KB – Exponential phase

<i>gnd</i>	KB – Exponential phase; LB – Exponential phase
<i>gatC</i>	KB – Exponential phase; LB – Exponential phase
<i>gatA</i> (T)	KB – Exponential phase
<i>gatZ</i>	KB – Exponential phase; LB – Exponential phase
<i>gatY</i>	KB – Exponential phase; LB – Exponential phase
<i>fruA</i>	KB – Exponential phase
<i>ypdE</i>	KB – Exponential phase
<i>ptsH</i>	KB – Exponential phase
<i>ptsI</i>	KB – Exponential phase; LB – Exponential phase
<i>yphD</i>	KB – Exponential phase
<i>fbaA</i>	KB – Exponential phase
<i>agaZ</i> (<i>kbaZ</i>)	KB – Exponential phase
<i>agaY</i> (<i>kbaY</i>)	KB – Exponential phase
<i>glmM</i>	KB – Exponential phase
<i>nanE</i>	KB – Exponential phase
<i>malP</i>	KB – Exponential phase; LB - Exponential phase
<i>glgA</i>	KB – Exponential phase
<i>glgC</i>	KB – Exponential phase
<i>glgB</i>	KB – Exponential phase
<i>ugpE</i>	KB – Exponential phase
<i>ugpA</i>	KB – Exponential phase
<i>ugpB</i>	KB – Exponential phase
<i>yiaO</i>	KB – Exponential phase
<i>sgbU</i>	KB – Exponential phase
<i>pgmI</i>	KB – Exponential phase
<i>glvC</i>	KB – Exponential phase
<i>rbsA</i>	KB – Exponential phase
<i>rbsK</i>	KB – Exponential phase
<i>yihP</i>	KB – Exponential phase
<i>yihS</i>	KB – Exponential phase
<i>yihT</i>	KB – Exponential phase
<i>yihV</i>	KB – Exponential phase
<i>frvB</i>	KB – Exponential phase
<i>rhaB</i>	KB – Exponential phase
<i>pfkA</i>	KB – Exponential phase
<i>tpiA</i>	KB – Exponential phase
<i>ptsA</i> (T)	KB – Exponential phase
<i>malE</i>	KB – Exponential phase; LB - Exponential phase
<i>alsC</i>	KB – Exponential phase
<i>glpT</i>	LB – Exponential phase
<i>rpe</i>	LB – Exponential phase
<i>yihR</i>	LB – Exponential phase
<i>gapA</i>	KB – Exponential phase; LB - Exponential phase
<i>rbsB</i>	KB – Exponential phase
<i>yigM</i> (ER)	KB – Exponential phase
<i>pgi</i>	KB – Exponential phase
<i>treA</i>	LB – Exponential phase
<i>tktA</i>	LB – Exponential phase
<i>gpmM</i>	LB – Exponential phase

<i>idnT</i> (E)	KB – Stationary phase
<i>kdgK</i>	LB – Stationary phase
<i>araG</i>	LB – Stationary phase
E – Amino acid transport and metabolism	
<i>carB</i> (F)	KB – Exponential phase
<i>dapD</i>	KB – Exponential phase
<i>dinJ</i>	KB – Exponential phase
<i>proB</i>	KB – Exponential phase
<i>yagE</i> (M)	KB – Exponential phase
<i>argF</i>	KB – Exponential phase
<i>yahI</i>	KB – Exponential phase
<i>oppC</i> (P)	KB – Exponential phase
<i>oppD</i> (P)	KB – Exponential phase
<i>puuP</i>	KB – Exponential phase
<i>ydcT</i>	KB – Exponential phase
<i>gatD</i> (R)	KB – Exponential phase
<i>yehY</i>	KB – Exponential phase
<i>lysP</i>	KB – Exponential phase
<i>yfbQ</i>	KB – Exponential phase
<i>hisM</i>	KB – Exponential phase
<i>hisJ</i> (T)	KB – Exponential phase
<i>usg</i>	KB – Exponential phase
<i>mnmC</i> (<i>trmC</i>) (S)	KB – Exponential phase
<i>eutJ</i>	KB – Exponential phase
<i>dapE</i>	KB – Exponential phase
<i>iscS</i>	KB – Exponential phase
<i>yphC</i> (R)	KB – Exponential phase
<i>yfhB</i>	KB – Exponential phase
<i>proV</i>	KB – Exponential phase
<i>proW</i>	KB – Exponential phase
<i>sdaC</i>	KB – Exponential phase; LB – Exponential phase
<i>gcvH</i>	KB – Exponential phase
<i>gcvT</i>	KB – Exponential phase
<i>pepP</i>	KB – Exponential phase
<i>yggP</i> (R)	KB – Exponential phase
<i>gltB</i>	KB – Exponential phase
<i>argD</i>	KB – Exponential phase
<i>asd</i>	KB – Exponential phase
<i>livF</i>	KB – Exponential phase
<i>livH</i>	KB – Exponential phase
<i>nikC</i> (P)	KB – Exponential phase
<i>nikD</i> (P)	KB – Exponential phase
<i>nikE</i> (P)	KB – Exponential phase
<i>dppF</i>	KB – Exponential phase
<i>ddpD</i> (<i>ydpP</i>) (P)	KB – Exponential phase; LB – Exponential phase
<i>sela</i>	KB – Exponential phase; LB – Exponential phase
<i>ilvC</i> (H)	KB – Exponential phase
<i>metE</i>	KB – Exponential phase

<i>pepQ</i>	KB – Exponential phase
<i>metL</i>	KB – Exponential phase
<i>argC</i>	KB – Exponential phase
<i>argH</i>	KB – Exponential phase
<i>metH</i>	KB – Exponential phase
<i>yjdL</i>	KB – Exponential phase
<i>aspA</i>	KB – Exponential phase; LB – Exponential phase
<i>oppA</i>	LB – Exponential phase
<i>trpB</i>	LB – Exponential phase
<i>trpC</i>	LB – Exponential phase
<i>ydcT</i>	LB – Exponential phase
<i>tdcC</i>	LB – Exponential phase
<i>tdcB</i>	LB – Exponential phase
<i>tnaA</i>	LB – Exponential phase
<i>proA</i>	KB – Exponential phase
<i>potD</i>	KB – Exponential phase
<i>asnA</i>	KB – Exponential phase; LB – Exponential phase
<i>glnK</i>	LB – Exponential phase
<i>glpB</i>	LB – Exponential phase
<i>speA</i>	LB – Exponential phase
<i>tdh</i> (R)	LB – Exponential phase
<i>gadA</i>	KB – Stationary phase
<i>ydiB</i>	LB – Stationary phase

F – Nucleotide transport and metabolism

<i>dgt</i>	KB – Exponential phase
<i>adk</i>	KB – Exponential phase
<i>purE</i>	KB – Exponential phase
<i>purB</i>	KB – Exponential phase
<i>nrdB</i>	KB – Exponential phase
<i>upp</i>	KB – Exponential phase
<i>purL</i>	KB – Exponential phase
<i>pyrE</i>	KB – Exponential phase
<i>ade</i>	KB – Exponential phase
<i>gpp</i> (P)	KB – Exponential phase
<i>purD</i>	KB – Exponential phase
<i>guaA</i>	LB – Exponential phase
<i>ygfU</i>	LB – Exponential phase

H – Coenzyme transport and metabolism

<i>ribF</i>	KB – Exponential phase
<i>nadC</i>	KB – Exponential phase
<i>hemL</i>	KB – Exponential phase
<i>mhpA</i> (C)	KB – Exponential phase
<i>dxs</i> (I)	KB – Exponential phase
<i>thiI</i> (P)	KB – Exponential phase
<i>moaA</i>	KB – Exponential phase
<i>rimK</i> (H)	KB – Exponential phase
<i>hemA</i>	KB – Exponential phase
<i>pdxH</i>	KB – Exponential phase

<i>folE</i>	KB – Exponential phase
<i>menC</i>	KB – Exponential phase
<i>menB</i>	KB – Exponential phase
<i>gshA</i>	KB – Exponential phase
<i>ubiH</i> (C)	KB – Exponential phase
<i>gshB</i> (J)	KB – Exponential phase
<i>ispB</i>	LB – Exponential phase
<i>coaE</i>	KB – Exponential phase
<i>kbl</i>	KB – Exponential phase
<i>moeA</i>	LB – Exponential phase
<i>pdxB</i> (E)	LB – Exponential phase
<i>hemY</i>	LB – Exponential phase
<i>ubiF</i> (C)	LB – Stationary phase
I – Lipid transport and metabolism	
<i>ispU</i>	KB – Exponential phase
<i>accA</i>	KB – Exponential phase
<i>prpE</i>	KB – Exponential phase
<i>aes</i>	KB – Exponential phase
<i>fabA</i>	KB – Exponential phase
<i>plsX</i>	KB – Exponential phase
<i>acpP</i> (Q)	KB – Exponential phase
<i>fadD</i> (Q)	KB – Exponential phase
<i>ucpA</i> (QR)	KB – Exponential phase; LB – Exponential phase
<i>idi</i>	KB – Exponential phase
<i>sbm</i> (<i>yliK</i>)	KB – Exponential phase
<i>garR</i>	KB – Exponential phase
<i>yhbT</i>	KB – Exponential phase
<i>accB</i>	KB – Exponential phase
<i>fadB</i>	KB – Exponential phase
<i>yihU</i>	KB – Exponential phase
<i>ygfF</i> (QR)	LB – Exponential phase
<i>ispD</i>	KB – Exponential phase
<i>accC</i>	KB – Exponential phase
V – Defense mechanisms	
<i>ybhF</i>	KB – Exponential phase
<i>rbbA</i>	KB – Exponential phase
<i>yibH</i>	KB – Exponential phase
U – Intracellular trafficking and secretion	
<i>tolB</i>	KB – Exponential phase
<i>secA</i>	KB – Exponential phase
<i>secG</i>	KB – Exponential phase
<i>secE</i>	KB – Exponential phase
<i>yidC</i>	LB – Exponential phase
Q – Secondary metabolites biosynthesis, transport and catabolism	
<i>mhpF</i>	KB – Exponential phase
<i>entF</i>	KB – Exponential phase
<i>entE</i>	KB – Exponential phase
<i>entB</i>	KB – Exponential phase

<i>smtA</i> (R)	KB – Exponential phase
<i>dhaR</i> (K)	KB – Exponential phase
R – General function prediction only	
<i>ybbB</i>	KB – Exponential phase
<i>ybfF</i>	KB – Exponential phase
<i>gsiA</i> (<i>yliA</i>)	KB – Exponential phase
<i>ybjI</i>	KB – Exponential phase; LB – Exponential phase
<i>yncB</i>	KB – Exponential phase
<i>ydfG</i>	KB – Exponential phase
<i>ynjD</i>	KB – Exponential phase
<i>yobA</i>	KB – Exponential phase
<i>yecA</i>	KB – Exponential phase
<i>yedE</i>	KB – Exponential phase
<i>mqo</i>	KB – Exponential phase
<i>yfcH</i>	KB – Exponential phase
<i>ypfH</i>	KB – Exponential phase
<i>ypfI</i>	KB – Exponential phase
<i>hcaD</i>	KB – Exponential phase
<i>yfiC</i>	KB – Exponential phase
<i>ecfD</i> (<i>yfiO</i>)	KB – Exponential phase
<i>yjfP</i>	KB – Exponential phase
<i>ygaF</i>	KB – Exponential phase
<i>yqaB</i>	KB – Exponential phase; LB – Exponential phase
<i>dkgA</i>	KB – Exponential phase
<i>nlpI</i>	KB – Exponential phase
<i>yheT</i>	KB – Exponential phase
<i>yrfG</i>	KB – Exponential phase
<i>glpG</i>	KB – Exponential phase
<i>bcsC</i>	KB – Exponential phase; LB – Exponential phase
<i>yicO</i>	KB – Exponential phase
<i>yieG</i>	KB – Exponential phase
<i>yigL</i>	KB – Exponential phase
<i>ubiB</i>	KB – Exponential phase
<i>yihA</i>	KB – Exponential phase
<i>actP</i>	KB – Exponential phase
<i>dcuA</i>	KB – Exponential phase; LB – Exponential phase
<i>ycjS</i>	LB – Exponential phase
<i>yhhX</i>	LB – Exponential phase
<i>ybjL</i>	KB – Exponential phase
<i>viaA</i>	KB – Exponential phase
<i>ybbM</i>	LB – Exponential phase
<i>ycsS</i>	LB – Exponential phase
<i>ybhL</i>	LB – Exponential phase
<i>ildD</i>	LB – Exponential phase
<i>yhiN</i>	LB – Exponential phase
S – Function unknown	
<i>yaaA</i>	KB – Exponential phase
<i>yaaH</i>	KB – Exponential phase

<i>yadR</i>	KB – Exponential phase
<i>ybgI</i>	KB – Exponential phase; LB – Exponential phase
<i>ychA</i>	KB – Exponential phase
<i>ydgA</i>	KB – Exponential phase
<i>ydhK</i>	KB – Exponential phase
<i>ydhS</i>	KB – Exponential phase
<i>ynhG</i>	KB – Exponential phase
<i>dedD</i>	KB – Exponential phase
<i>ygiD</i> (<i>zupT</i>)	KB – Exponential phase
<i>yqiK</i>	KB – Exponential phase
<i>ygjQ</i>	KB – Exponential phase
<i>ygiD</i>	KB – Exponential phase
<i>yrbK</i>	KB – Exponential phase
<i>yhdP</i>	KB – Exponential phase
<i>yhhQ</i>	KB – Exponential phase
<i>yicC</i>	KB – Exponential phase
<i>rmuC</i>	KB – Exponential phase
<i>yihF</i>	KB – Exponential phase; LB – Exponential phase
<i>yjbJ</i>	KB – Exponential phase
<i>yafQ</i>	LB – Exponential phase
<i>yefD</i>	KB – Exponential phase
<i>yjeF</i> (G)	KB – Exponential phase
<i>ytfN</i>	LB – Exponential phase
Not on COG List	
<i>araC</i>	KB – Exponential phase
<i>ftsW</i>	KB – Exponential phase
<i>lpxC</i>	KB – Exponential phase
<i>panC</i>	KB – Exponential phase
<i>yadM</i>	KB – Exponential phase
<i>sfsA</i>	KB – Exponential phase
<i>tsf</i>	KB – Exponential phase
<i>yagV</i>	KB – Exponential phase
<i>yaiL</i>	KB – Exponential phase
<i>yaiA</i>	KB – Exponential phase
<i>hupB</i>	KB – Exponential phase; LB – Exponential phase
<i>nrfB</i>	KB – Exponential phase
<i>hokE</i>	KB – Exponential phase
<i>cspE</i>	KB – Exponential phase
<i>ybfE</i>	KB – Exponential phase
<i>iaaA</i>	KB – Exponential phase
<i>ybjJ</i>	KB – Exponential phase
<i>ybjN</i>	KB – Exponential phase
<i>ybjQ</i>	KB – Exponential phase
<i>somA</i> (<i>ybjX</i>)	KB – Exponential phase
<i>mgsA</i>	KB – Exponential phase
<i>cspG</i>	KB – Exponential phase
<i>yceH</i>	KB – Exponential phase
<i>yceG</i>	KB – Exponential phase

<i>yehQ</i>	KB – Exponential phase
<i>yehQ</i>	KB – Exponential phase; LB – Exponential phase; KB – Stationary phase
<i>recE</i>	KB – Exponential phase
<i>ydcA</i>	KB – Exponential phase
<i>ydcP</i>	KB – Exponential phase
<i>yneG</i>	KB – Exponential phase
<i>yneH</i>	KB – Exponential phase
<i>ynfD</i>	KB – Exponential phase
<i>ihfA</i>	KB – Exponential phase
<i>ydjY</i>	KB – Exponential phase
<i>edd</i>	KB – Exponential phase; LB – Exponential phase
<i>zwf</i>	KB – Exponential phase
<i>yecM</i>	KB – Exponential phase
<i>flhC</i>	KB – Exponential phase
<i>flhD</i>	KB – Exponential phase
<i>yecH</i>	KB – Exponential phase; LB – Exponential phase
<i>yehQ</i>	KB – Exponential phase
<i>yeiM</i>	KB – Exponential phase
<i>yfcZ</i>	KB – Exponential phase
<i>yfdN</i>	KB – Exponential phase
<i>yfdX</i>	KB – Exponential phase
<i>eutC</i>	KB – Exponential phase
<i>hcaT</i>	KB – Exponential phase
<i>yphG</i>	KB – Exponential phase
<i>yfiL</i>	KB – Exponential phase
<i>yfjO</i>	KB – Exponential phase
<i>ypjC</i>	KB – Exponential phase
<i>csrA</i>	KB – Exponential phase; LB – Exponential phase
<i>hypD</i>	KB – Exponential phase
<i>ppdC</i>	KB – Exponential phase
<i>xdhB</i>	KB – Exponential phase
<i>ygfB</i>	KB – Exponential phase
<i>ygfA</i>	KB – Exponential phase
<i>yggD</i>	KB – Exponential phase
<i>yggF</i>	KB – Exponential phase
<i>galP</i>	KB – Exponential phase
<i>yggN</i>	KB – Exponential phase
<i>yggL</i>	KB – Exponential phase
<i>yqhC</i>	KB – Exponential phase
<i>glgS</i>	KB – Exponential phase
<i>yqiJ</i>	KB – Exponential phase
<i>ygjE</i>	KB – Exponential phase
<i>agaW</i>	KB – Exponential phase
<i>rpsO</i>	KB – Exponential phase
<i>yrbL</i>	KB – Exponential phase
<i>nanT</i>	KB – Exponential phase
<i>rplM</i>	KB – Exponential phase
<i>def</i>	KB – Exponential phase

<i>rplN</i>	KB – Exponential phase
<i>rplD</i>	KB – Exponential phase
<i>rtcA</i>	KB – Exponential phase
<i>bcsG</i>	KB – Exponential phase
<i>yhjX</i>	KB – Exponential phase
<i>viaF</i>	KB – Exponential phase
<i>glyQ</i>	KB – Exponential phase
<i>ecfI (yidQ)</i>	KB – Exponential phase
<i>mdtL</i>	KB – Exponential phase
<i>ilvD</i>	KB – Exponential phase
<i>cyaA</i>	KB – Exponential phase; LB – Exponential phase
<i>yihI</i>	KB – Exponential phase
<i>glnA</i>	KB – Exponential phase
<i>yiiD</i>	KB – Exponential phase
<i>rhaA</i>	KB – Exponential phase
<i>kdgT</i>	KB – Exponential phase
<i>cdh</i>	KB – Exponential phase
<i>menG (rraA)</i>	KB – Exponential phase
<i>pagB (yjbD)</i>	KB – Exponential phase
<i>yjbE</i>	KB – Exponential phase
<i>yjbF</i>	KB – Exponential phase
<i>phnH</i>	KB – Exponential phase
<i>proP</i>	KB – Exponential phase
<i>yacL</i>	LB – Exponential phase
<i>frsA</i>	LB – Exponential phase
<i>yaiC (adrA)</i>	LB – Exponential phase
<i>yaiI</i>	LB – Exponential phase
<i>ybgJ</i>	LB – Exponential phase
<i>yliE</i>	LB – Exponential phase
<i>ydgD</i>	LB – Exponential phase
<i>ydiU</i>	LB – Exponential phase
<i>cvpA</i>	LB – Exponential phase
<i>eutB</i>	LB – Exponential phase
<i>gudP</i>	LB – Exponential phase
<i>yqcC</i>	LB – Exponential phase
<i>ygjR</i>	LB – Exponential phase
<i>garP</i>	LB – Exponential phase
<i>lamB</i>	LB – Exponential phase
<i>yjeI</i>	LB – Exponential phase
<i>yjfM</i>	LB – Exponential phase
<i>ybjL</i>	KB – Exponential phase
<i>ydiM</i>	KB – Exponential phase
<i>yebC</i>	KB – Exponential phase
<i>ppk</i>	KB – Exponential phase
<i>yghJ</i>	KB – Exponential phase
<i>rpsL</i>	KB – Exponential phase
<i>setA</i>	LB – Exponential phase
<i>can</i>	LB – Exponential phase
<i>mhpB</i>	LB – Exponential phase

<i>agp</i>	LB – Exponential phase
<i>yecR</i>	LB – Exponential phase
<i>yedD</i>	LB – Exponential phase
<i>yfjQ</i>	LB – Exponential phase
<i>ansB</i>	LB – Exponential phase
<i>agaC</i>	LB – Exponential phase
<i>gspH</i>	LB – Exponential phase
<i>yhjE</i>	LB – Exponential phase
<i>yhjY</i>	LB – Exponential phase
<i>ytfJ</i>	LB – Exponential phase
<i>msrA</i>	LB – Exponential phase
<i>ybgS</i>	KB – Stationary phase
<i>rmf</i>	KB – Stationary phase; LB – Stationary phase
<i>yohK</i>	KB – Stationary phase
<i>yciN</i>	LB – Stationary phase
RNA	
<i>ssrA</i>	KB – Exponential phase; LB – Exponential phase
<i>pheV</i>	KB – Exponential phase
<i>rnpB</i>	KB – Exponential phase
<i>sraG</i>	KB – Exponential phase
<i>selC</i>	KB – Exponential phase
<i>gcvB</i>	LB – Exponential phase
<i>ffs</i>	KB – Exponential phase; LB – Exponential phase
<i>valT</i>	LB – Exponential phase

^a Gene name indicates the corresponding coding region that the cDNA was annotated to in *E. coli* K-12 MG1655 (Accession number U00096).

^b Pulldown condition abbreviations: KB = Kornberg broth (1.1% K₂HPO₄, 0.85% KH₂PO₄, 0.6% yeast extract, 0.5% glucose, pH 6.8); LB = Luria broth, pH 7.4.

Table 2. Identities of proteins from two dimensional protein gel analysis.

Accession No.	MG1655 Gene No.	Gene Name	Fold Change
Luria Broth, Exponential Phase			
gi 26250243	b3602	<i>yibL</i>	2.79
gi 26246978	b0957	<i>ompA</i>	2.54
gi 26246978	b0957	<i>ompA</i>	2.20
gi 16128831	b0863	<i>artI</i>	1.99
gi 16131280	b3403	<i>pckA</i>	1.90
gi 3212630	b0811	<i>glnH</i>	1.90
gi 49176218	b2426	<i>ucpA</i>	1.90
gi 1311293	b4034	<i>malE</i>	1.83
gi 32329155	b0957	<i>ompA</i>	1.82
gi 26246978	b0957	<i>ompA</i>	1.78
gi 16131280	b3403	<i>pckA</i>	1.72
gi 1311293	b4034	<i>malE</i>	1.67
gi 16130152	b2215	<i>ompC</i>	1.65
gi 19568909	b0231	<i>dinB</i>	-1.53
gi 26248857	b2498	<i>upp</i>	-1.79
gi 4902909	b0169	<i>rpsB</i>	-2.47
gi 42842	b0169	<i>rpsB</i>	-2.92
Luria Broth, Stationary Phase			
gi 16130152	b2215	<i>ompC</i>	2.16
gi 49176218	b2426	<i>ucpA</i>	1.68
gi 16129718	b1764	<i>seldD</i>	1.50
gi 42900	b0911	<i>rpsA</i>	-1.52
gi 26249817	b3236	<i>mdh</i>	-1.53
gi 1314675	b2417	<i>crr</i>	-1.54
gi 563868	b2779	<i>eno</i>	-1.59
gi 16130062	b2124	<i>yehS</i>	-1.61
gi 26248187	b1920	<i>fliY</i>	-1.64
gi 16128279	b0294	<i>matA</i>	-1.64
gi 24111953	b0605	<i>ahpC</i>	-1.65
gi 26246721	b0755	<i>gpmA</i>	-1.72
gi 26249339	b2926	<i>pgk</i>	-1.73
gi 26248857	b2498	<i>upp</i>	-1.90
gi 26249339	b2926	<i>pgk</i>	-1.94
gi 563868	b2779	<i>eno</i>	-2.09
gi 12516470	b2150	<i>mglB</i>	-2.20

gi 16132194	b4376	<i>osmY</i>	-2.40
gi 41287	b2133	<i>dld</i>	-2.60
Kornberg Broth + 0.5% glucose, Exponential Phase			
gi 16128885	b0918	<i>kdsB</i>	5.00
gi 13360177	b0688	<i>pgm</i>	3.25
gi 56480572	b4139	<i>aspA</i>	2.22
gi 2147837	b0957	<i>ompA</i>	2.18
gi 56413951	b0930	<i>asnS</i>	2.00
gi 24111996	b0728	<i>sucC</i>	1.98
gi 16129622	b1664	<i>ydhQ</i>	1.87
gi 16130033	b2095	<i>gatZ</i>	1.83
gi 16129718	b1764	<i>seld</i>	1.81
gi 39654499	b4291	<i>fecA</i>	-1.83
gi 26246488	b0473	<i>htpG</i>	-1.83
gi 405895	b2114	<i>metG</i>	-1.84
gi 54294026	(b3832)??	(<i>yigN</i>)??	-1.85
gi 1805568	b2508	<i>guaB</i>	-1.87
gi 33383753	b2499	<i>purM</i>	-2.02
gi 56480489	b3942	<i>katG</i>	-2.03
gi 27574023	b0903	<i>pflB</i>	-2.05
gi 1805568	b2508	<i>guaB</i>	-2.20
gi 27574023	b0903	<i>pflB</i>	-2.29
gi 147478	b2780	<i>pyrG</i>	-2.31
gi 43237	b3962	<i>udhA</i>	-2.33
gi 42595	b4006	<i>purH</i>	-5.21
Kornberg Broth + 0.5% glucose, Stationary Phase			
gi 1742120	b1299	<i>ycjC</i>	1.96
gi 26250394	b2003	<i>yeeT</i>	1.60
gi 440007	b3236	<i>mdh</i>	1.50
gi 22035193	b1790	<i>yeaM</i>	-1.57
gi 1736707	b2028	<i>udg</i>	-1.59
gi 26250945	NT01EC5045		-1.59
gi 26250243	b3602	<i>yibL</i>	-1.60
gi 16129077	b1114	<i>mfd</i>	-1.63
gi 38703945	NT01EC0673		-2.26

Table 3. Genes that copurified with CsrA-His6 and identified in two dimensional protein gel analysis.

Gene	Condition in pull down	Condition in protein analysis
<i>ompA</i>	LB ^a , exponential phase KB ^b , exponential phase	LB, exponential phase KB, exponential phase
<i>pckA</i>	KB, exponential phase	LB, exponential phase
<i>malE</i>	LB, exponential phase KB, exponential phase	LB, exponential phase
<i>upp</i>	KB, exponential phase	LB, exponential phase LB, stationary phase
<i>ompC</i>	LB, exponential phase KB, exponential phase	LB, exponential phase LB, stationary phase
<i>ucpA</i>	LB, exponential phase KB, exponential phase	LB, exponential phase LB, stationary phase
<i>dld</i>	KB, exponential phase	LB, stationary phase
<i>mdh</i>	KB, exponential phase	LB, stationary phase KB, stationary phase
<i>pflB</i>	KB, exponential phase	KB, exponential phase
<i>pgm</i>	KB, exponential phase	KB, exponential phase
<i>aspA</i>	LB, exponential phase KB, exponential phase	KB, exponential phase
<i>katG</i>	LB, exponential phase KB, exponential phase	KB, exponential phase
<i>gatZ</i>	LB, exponential phase KB, exponential phase	KB, exponential phase

^a Luria broth, pH 7.4

^b Kornberg broth (1.1% K₂HPO₄, 0.85% KH₂PO₄, 0.6% yeast extract, 0.5% glucose, pH 6.8)

Table 4. Strains, phage and plasmids used in this study.

Strain, plasmid or phage	Genotype or Description	Source
Strain		
MG1655	F ⁻ λ ⁻	Michael Cashel
TRMG1655	MG1655 <i>csrA::kan</i>	(Romeo <i>et al.</i> , 1993)
CF7789	MG1655 Δ <i>lacIZ</i> (<i>Mlu</i> I)	Michael Cashel
TRCF7789B ⁻ C ⁻	CF7789 <i>csrA::kan</i> Δ <i>csrB::cam</i> Δ <i>csrC::tet</i>	(Mercante <i>et al.</i> , 2006)
CF1693	MG1655 Δ <i>relA251::kan</i> Δ <i>spoT207::cam</i>	(Xiao <i>et al.</i> , 1991)
CF9239	MG1655 <i>dksA::kan</i>	Michael Cashel
CF9240	MG1655 <i>dksA::tet</i>	(Brown <i>et al.</i> , 2002)
RH MG1655	<i>rpoS::Tn10</i>	(Gudapaty <i>et al.</i> , 2001)
UY CF7789	CF7789 <i>uvrY::cam</i>	(Suzuki <i>et al.</i> , 2002)
CAG18642	<i>zfh-3131::Tn10</i> (near <i>csrA</i>)	(Singer <i>et al.</i> , 1989)
KSA712	CF7789 φ(<i>csrA'</i> -' <i>lacZ</i>)	(Jackson <i>et al.</i> , 2002)
KSB837	CF7789 φ(<i>csrB-lacZ</i>)	(Gudapaty <i>et al.</i> , 2001)
GS1114	CF7789 φ(<i>csrC-lacZ</i>)	(Weilbacher <i>et al.</i> , 2003)
KSY009	CF7789 φ(<i>uvrY'</i> -' <i>lacZ</i>)	(Suzuki <i>et al.</i> , 2002)
CF80005	BL21(λDE3) pGN1	(Gentry <i>et al.</i> , 1993)
DHB6521	SM551 λInCh1 (Kan ^r)	(Boyd <i>et al.</i> , 2000)
SM551 (DHB6501)	F ⁻ λ ^s Δ <i>lac(MS265)mel</i> NalA ^r <i>supF58</i>	(Boyd <i>et al.</i> , 2000)
dH5α λpir	F ⁻ Δ(<i>lacZYA-argF</i>) <i>U169 recA1 endA1</i> <i>hsdR17 suupE44thi-1 gyrA96 relA1</i> λ:: <i>pir</i>	(Bourassa and Camilli, 2009)
Plasmids		
pBR322	Cloning vector; Amp ^r Tet ^r	(Sambrook <i>et al.</i> , 1989)
pUC19	Cloning vector; Amp ^r	(Yanisch-Perron <i>et al.</i> , 1985)
pCRA16	<i>csrA</i> in blunt-ended <i>VspI</i> site of pBR322	(Suzuki <i>et al.</i> , 2002)
pUY14	<i>uvrY</i> in blunt-ended <i>VspI</i> site of pBR322	(Suzuki <i>et al.</i> , 2002)
pGB2	Cloning vector; Spc/Str ^r	(Churchward <i>et al.</i> , 1984)
pCsrA	<i>csrA</i> cloned into <i>HindIII</i> and <i>EcoRI</i> of pGB2	This study
pHM1883	pGB2 with <i>Ptac</i> promoter	(Potrykus <i>et al.</i> , 2006)
pHM1506	<i>dksA</i> expressed from <i>Ptac</i> promoter in pGB2	(Potrykus <i>et al.</i> , 2006)
pJK537	<i>dksA</i> wild-type allele in pBR322	(Kang and Craig, 1990)
pHM1684	pJK537 <i>dksA</i> D71N D74N	This study

pMLB1034	Vector for <i>lacZ</i> translation fusions; Amp ^r	(Silhavy <i>et al.</i> , 1984)
pRELZ	pMLB1034 $\phi(\textit{relA}'\text{-}'\textit{lacZ})$	This study
pDKSZ	pMLB1034 $\phi(\textit{dksA}'\text{-}'\textit{lacZ})$	This study
pAH125	Vector for <i>lacZ</i> transcriptional fusions; Kan ^r	(Haldimann and Wanner, 2001)
pLFT	Vector for <i>lacZ</i> transcriptional fusions; Amp ^r	This study
pRELZtxn	pLFT $\phi(\textit{relA-lacZ})$	This study
pDKSZtxn	pLFT $\phi(\textit{dksA-lacZ})$	This study
pLFX	Vector for <i>lacZ</i> translational fusions; Amp ^r	This study
pUV5	Vector for <i>lacZ</i> leader fusions; Amp ^r	This study
pRELZplac	pUV5 $\phi(\textit{PlacUV5relA}'\text{-}'\textit{lacZ})$	This study
pDKSZplac	pUV5 $\phi(\textit{PlacUV5dksA}'\text{-}'\textit{lacZ})$	This study
pSPOZplac	pUV5 $\phi(\textit{PlacUV5rpoZ-spoT}'\text{-}'\textit{lacZ})$	This study
pBARAZ	pLFX $\phi(\textit{barA}'\text{-}'\textit{lacZ})$	This study
pINT-ts	Vector for integration; Amp ^r	(Haldimann and Wanner, 2001)
pPFINT	Tet ^r cloned into pINT-ts	This study
pPB77	contains <i>trp</i> leader (-1 to +111) of <i>B. subtilis</i>	(Babitzke <i>et al.</i> , 1994)
Bacteriophages		
P1vir	Strictly lytic P1	Carol Gross
λ InCh1	For genomic insertions; Kan ^r	(Boyd <i>et al.</i> , 2000)

Table 5. Primers used in this study.

Primer name	Primer sequence (5' to 3')
Genetic Techniques	
relA-F	GTCGAATTCTCGACGTCAAACAATGCC
relA-R	GTCGGATCCACCGCAACCATCGTCCTCTC
dksA-F	GTCGAATTCGACGAAAGAGGCTATCCTTA
dksA-R	GTCGGATCCTCTTCTTGCATGTTGCTTCTC
relA-F-txn	GTCCTGCAGTCGACGTCAAACAATGCC
relA-R-txn	GTCGGATCCCGGTTTCGAGTATCTCACTA
dksA-F-txn	GTCCTGCAGCACAGTTGTCAAGTGTT
dksA-R-txn	GTCGGATCCGGCCGCTATAAATAGCA
relA-F-plac	GTCGAATTCGTCTCTGGTGAGATGCCCTG
dksA-F-plac	GTCGAATTCCTCATTTCCTCCCGA
rpoZspoT-F-plac	GTCGAATTCATTCTTACCTGTGGAGC
rpoZspoT-R-plac	GTCGAATTCACAAGGGCGACCCGCTTTG
barA-F	GACGCTGCAGGCCATTCCAACGCACGCGCT
barA-R	GACGGATCCTTGGTCATGGAGTTCCGTTATG
csrA-F-pGB2	GTCGAATTCACAGATCGTGTGAAAGCAG
csrA-R-pGB2	GTCAAGCTTTTAGTAAGTGGACTGCTGGG
AmpRF	AGCTCGATCGAATTGGTTTCTTAGACGTCAGGTGGCA
AmpRR	AGCTCGGCGGCCGCGGTCTGACGCTCAGTGGAACGAAA
LPF-19	TAATCTGCAGCTCATTAGGCACCCC
LPF-20	GGCGAATTCTCCACACATTATACGAG
LPF-21	AGCTCGATCGATAAATAGGCGTATCACGAGGCCCTTT
LPF-22	TGGTTTGCGCATTACAGTTCTCC
RNA EMSAs	
relA-F-T7	TAATACGACTCACTATAGGCTGCAACGCTGGCTCGGGAT
relA-R-T7	GTGCACTTCTTACCGCAACCAT
dksA-T7	TAATACGACTCACTATAGGGCCTCATTTCCTCCCGAACA TGGGGATCGATAGTGCCTGTTAAGGAGAAGCAACATGCA AGAAG
GC-dksA-T7	CTTCTTGCATGTTGCTTCTCCTTAACACGCACTATCGATCC CCATGTTCCGGGGGAAAATGAGGCCCTATAGTGAGTCGT ATTA
gmk-F-T7	TAATACGACTCACTATAGGGTATGTAGGCTTTATTTCCG
gmk-R-T7	CAATATAAAGCGTGCCTTGA

rpoZ-T7	TAATACGACTCACTATAGGATTTCTTCACCTGTGGAGCTT TTTAAGTATGGCACGCGTAACTGTTTCAGGACGCTGTAGAG
GC-rpoZ-T7	CTCTACAGCGTCCTGAACAGTTACGCGTGCCATACTTAAA AAGCTCCACAGGTGAAGAAATCCTATAGTGAGTCGTATTA
rt-qRT-PCR	
relA-F-taqman	CGGCGTGCGTGATATGG
relA-R-taqman	TTCGGAGGAAACAGAATCAGTGT
relA-6FAM-BHQ1	CGATCCGCCAGCTGAAAGCG
spoT-F-taqman	TGCAGGATATCCGCGTCAT
spoT-R-taqman	CCCAGCGTGCGCATGT
spoT-6FAM-BHQ1	CTCATCAAACCTTGCCGACCGT
dksA-F-taqman	CGGGCGAAGAGTATATGAATGAA
dksA-R-taqman	GATTACGCCATGCTTCCAGAA
dksA-6FAM-BHQ1	CCCAGCTGGCGCACTTCCGT
Primer Extension	
pdksA2	CCCCAGGGATGGCGAGAATACTCAGC
Removal of rRNA from CsrA-bound RNA fractions	
SSUrRNA1F	GAAGAGTTTGATCATGGCTCAG
SSUrRNA2R	CTTAACAAACCGCCTGCGTGCGC
SSUrRNA3F	GCACCGGCTAACTCCGTGCCAGC
SSUrRNA4R	GGTTGCGCTCGTTGCGGGACTTAAC
SSUrRNA5F	GGCTGTTCGTCAGCTCGTGTTGTGA
SSUrRNA6R	AAGGAGGTGATCCAACCGCA
LSUrRNA1F	GCGACTAAGCGTACACGGTGGATG
LSUrRNA2R	GCCACAAGTCATCCGCTAATTTTTC
LSUrRNA3F	CTGGAGGACCGAACCGACTAATG
LSUrRNA4R	CACCTTCACAGGCTTACAGAACGC
LSUrRNA5F	CCATGCACCGAAGCTGCGGCAGCG
LSUrRNA6R	CTTCGACTGATTTTCAGCTCCACG
LSUrRNA7F	GGCACGCTGATATGTAGGTGAAGC
LSUrRNA8R	CGTCACGCTCGCAGTCAAGCTGGC
LSUrRNA9F	CCTGGTCCGACATCAGGAGGTTAG
LSUrRNA10R	AAGCCTCACGGTTCATTAGTACCG

MATERIALS AND METHODS

Preparation of CsrA-bound RNA for 454 Sequencing. *E. coli* CsrA-His₆ protein was purified as described previously (Mercante *et al.*, 2006) from TRCF7789B⁻C⁻ grown at 37°C to exponential (OD₆₀₀ = 0.5) or stationary phase (8 hours) in either LB medium or Kornberg broth (1.1% K₂HPO₄, 0.85% KH₂PO₄, 0.6% yeast extract, 0.5% glucose, pH 6.8). The protein-containing fractions were pooled, and RNA was extracted three times by acid phenol (pH 4.5) and twice by chloroform. Isolated RNA was recovered by ethanol precipitation. Purified RNA was fractionated on 1.5% formaldehyde-agarose gels, and most products were approximately 100-200 nt in length. Because large quantities of ribosomal RNA had been identified through trial experiments, rRNA was removed by annealing biotinylated ssDNA complementary to rRNA sequences and subsequently removing these complexes. Briefly, dsDNA was synthesized using primers SSUrRNA1F through LSUrRNA10R (Table S5) to generate three PCR products complementary to 16S rRNA and five PCR products complementary to 23S rRNA. An additional PCR reaction containing only the reverse primer was performed to create antisense ssDNA, which was then labeled with biotin using the Biotin 3' End DNA Labeling Kit (Pierce Biotechnology, Rockford, IL). Equal amounts of biotinylated ssDNA resuspended in TE buffer were added to purified RNA, and the mixture was heated up to 80°C for 5 min and allowed to cool to 4°C over 45 min. The biotinylated ssDNA-rRNA complexes were removed per manufacturer's instructions using the Streptavidin MagneSphere® Paramagnetic Particles (Promega, Madison, WI) and a magnetic separation stand. Assuming 90% of the original purified RNA fraction was rRNA, this process removed 49% of rRNA. Subsequent RNA was converted to cDNA using random hexamer primers and the Universal RiboClone cDNA Synthesis System

(Promega, Madison, WI) according to the manufacturer's instructions. Because random hexamer primers were used, the resulting cDNA did not necessarily possess a CsrA binding site, but may encode flanking sequences. The resulting cDNA was blunt-ended using T4 DNA polymerase (NEB) and phosphorylated by T4 polynucleotide phosphorylase (NEB). Before sequencing, cDNA was checked for integrity by efficient cloning into the *HincII* site of pUC19. Because cDNA quantities were limited, the Genomics Core of the University of Florida's Interdisciplinary Center for Biotechnology Research (ICBR) performed limited PCR amplification of the cDNA library. cDNA was sequenced using the 454 Life Sciences GS-20 Sequencer and annotated against the MG1655 genome (Accession number U00096). The identified transcripts were collated according to function into Clusters of Orthologous Groups of proteins (COGs) (Tatusov *et al.*, 1997).

Two-dimensional protein gels. Proteomics experiments were performed using differential in-gel electrophoresis technology (GE Biosystems, Piscataway, NJ) and *E. coli* MG1655 or TRMG1655 (*csrA::kan*) cells grown at 37°C to exponential ($OD_{600} = 0.5$) or stationary phase (8 hours) in either LB medium or Kornberg broth (1.1% K_2HPO_4 , 0.85% KH_2PO_4 , 0.6% yeast extract, 0.5% glucose, pH 6.8). Cell pellets were washed three times in wash buffer (10 mM Tris, pH 8.0, 5 mM magnesium acetate) at 4°C for 4 min at 12,000 g. The pellets were then resuspended and lysed in 1 ml of lysis buffer (8 M urea, 20 mM Tris, pH 8.5, 5 mM magnesium acetate, 4% (w/v) CHAPS) for 30 min on ice followed by sonication (6 x 10s bursts). The lysate was then centrifuged for 10 min at 12,000 g at 4°C and the supernatant was retained for the next steps. After determining the protein concentrations of each sample (Bicinchoninic acid protein assay, Pierce

Biotechnology, Rockford, IL), 25 µg of each sample was labeled (for 10 min in the dark) at lysine residues with 1 µl of either Cy2 (MG1655 samples) or Cy3 (TRMG1655 samples) dye conjugates. The labeling reactions were stopped with the addition of lysine to a final concentration of 1 mM. Following Cy2 and Cy3 labeling, each sample was mixed with an equal amount of unlabeled protein and paired samples (ie. MG1655 and TRMG from KB-0.5) were mixed together and then applied to an IPGPhor IEF strip (24 cm, non-linear, pH 3-11) and subjected to isoelectric focusing (IEF) to separate the proteins by pI. After IEF, the strips were washed in equilibration buffer (6 M urea, 10 mM Tris pH 6.8, 30% glycerol, 1% SDS) and applied to the top of a 12% SDS-polyacrylamide gel to separate the proteins by size. After electrophoresis, the gel was scanned on a Typhoon fluorescent scanner (GE Biosystems) at the appropriate wavelengths for each dye (Cy2, 488 nm excitation, 520 nm emission; Cy3, 532 nm excitation, 580 nm emission). The subsequent images were then overlaid and analyzed with Decyder Differential In-Gel Analysis (DIA) software (version 4.0, GE Biosystems). Differentially expressed proteins were then excised by a robotic spot picker, digested with trypsin, and tryptic peptides were analyzed using a matrix-associated laser desorption ionization-time-of-flight/time-of-flight (MALDI-ToF/ToF) spectrometer (Applied Biosystems). Protein IDs were obtained by querying protein databases with both the tryptic fingerprint data as well as primary amino acid sequence data obtained from the MALDI-ToF/ToF.

REFERENCES

- Babitzke, P., J. T. Stults, S. J. Shire and C. Yanofsky. (1994) TRAP, the *trp* RNA-binding attenuation protein of *Bacillus subtilis*, is a multisubunit complex that appears to recognize G/UAG repeats in the *trpEDCFBA* and *trpG* transcripts. *J Biol Chem* **269**: 16597-16604.
- Bourassa, L. and A. Camilli. (2009) Glycogen contributes to the environmental persistence and transmission of *Vibrio cholerae*. *Mol Microbiol* **72**: 124-138.
- Boyd, D., D. S. Weiss, J. C. Chen and J. Beckwith. (2000) Towards single-copy gene expression systems making gene cloning physiologically relevant: lambda InCh, a simple *Escherichia coli* plasmid-chromosome shuttle system. *J Bacteriol* **182**: 842-847.
- Brown, L., D. Gentry, T. Elliott and M. Cashel. (2002) DksA affects ppGpp induction of RpoS at a translational level. *J Bacteriol* **184**: 4455-4465.
- Churchward, G., D. Belin and Y. Nagamine. (1984) A pSC101-derived plasmid which shows no sequence homology to other commonly used cloning vectors. *Gene* **31**: 165-171.
- Gentry, D., C. Bengra, K. Ikehara and M. Cashel. (1993) Guanylate kinase of *Escherichia coli* K-12. *J Biol Chem* **268**: 14316-14321.
- Gudapaty, S., K. Suzuki, X. Wang, P. Babitzke and T. Romeo. (2001) Regulatory interactions of Csr components: the RNA binding protein CsrA activates *csrB* transcription in *Escherichia coli*. *J Bacteriol* **183**: 6017-6027.

- Haldimann, A. and B. L. Wanner. (2001) Conditional-replication, integration, excision, and retrieval plasmid-host systems for gene structure-function studies of bacteria. *J Bacteriol* **183**: 6384-6393.
- Jackson, D. W., K. Suzuki, L. Oakford, J. W. Simecka, M. E. Hart and T. Romeo. (2002) Biofilm formation and dispersal under the influence of the global regulator CsrA of *Escherichia coli*. *J Bacteriol* **184**: 290-301.
- Kang, P. J. and E. A. Craig. (1990) Identification and characterization of a new *Escherichia coli* gene that is a dosage-dependent suppressor of a *dnaK* deletion mutation. *J Bacteriol* **172**: 2055-2064.
- Mercante, J., K. Suzuki, X. Cheng, P. Babitzke and T. Romeo. (2006) Comprehensive alanine-scanning mutagenesis of *Escherichia coli* CsrA defines two subdomains of critical functional importance. *J Biol Chem* **281**: 31832-31842.
- Potrykus, K., D. Vinella, H. Murphy, A. Szalewska-Palasz, R. D'Ari and M. Cashel. (2006) Antagonistic regulation of *Escherichia coli* ribosomal RNA *rrnB* P1 promoter activity by GreA and DksA. *J Biol Chem* **281**: 15238-15248.
- Romeo, T., M. Gong, M. Y. Liu and A. M. Brun-Zinkernagel. (1993) Identification and molecular characterization of *csrA*, a pleiotropic gene from *Escherichia coli* that affects glycogen biosynthesis, gluconeogenesis, cell size, and surface properties. *J Bacteriol* **175**: 4744-4755.
- Sambrook, J., E. F. Fritsch and T. Maniatis. (1989) *Molecular cloning : a laboratory manual, 2nd ed.*, p. x, 545 p. Cold Spring Harbor Laboratory, Cold Spring Harbor, N.Y.

- Silhavy, T. J., M. L. Berman, and L. W. Enquist. (1984) *Experiments with gene fusions*, p. xv, 303 p., 301 p. of plates. Cold Spring Harbor Laboratory, Cold Spring Harbor, N.Y.
- Singer, M., T. A. Baker, G. Schnitzler, S. M. Deischel, M. Goel, W. Dove, K. J. Jaacks, A. D. Grossman, J. W. Erickson and C. A. Gross. (1989) A collection of strains containing genetically linked alternating antibiotic resistance elements for genetic mapping of *Escherichia coli*. *Microbiol Rev* **53**: 1-24.
- Suzuki, K., X. Wang, T. Weilbacher, A. K. Pernestig, O. Melefors, D. Georgellis, P. Babitzke and T. Romeo. (2002) Regulatory circuitry of the CsrA/CsrB and BarA/UvrY systems of *Escherichia coli*. *J Bacteriol* **184**: 5130-5140.
- Tatusov, R. L., E. V. Koonin and D. J. Lipman. (1997) A genomic perspective on protein families. *Science* **278**: 631-637.
- Weilbacher, T., K. Suzuki, A. K. Dubey, X. Wang, S. Gudapaty, I. Morozov, C. S. Baker, D. Georgellis, P. Babitzke and T. Romeo. (2003) A novel sRNA component of the carbon storage regulatory system of *Escherichia coli*. *Mol Microbiol* **48**: 657-670.
- Xiao, H., M. Kalman, K. Ikehara, S. Zemel, G. Glaser and M. Cashel. (1991) Residual guanosine 3',5'-bispyrophosphate synthetic activity of *relA* null mutants can be eliminated by *spoT* null mutations. *J Biol Chem* **266**: 5980-5990.
- Yanisch-Perron, C., J. Vieira and J. Messing. (1985) Improved M13 phage cloning vectors and host strains: nucleotide sequences of the M13mp18 and pUC19 56vectors. *Gene* **33**: 103-119.